

National Institute for Advanced Transportation Technology

NIATT

ANNUAL REPORT

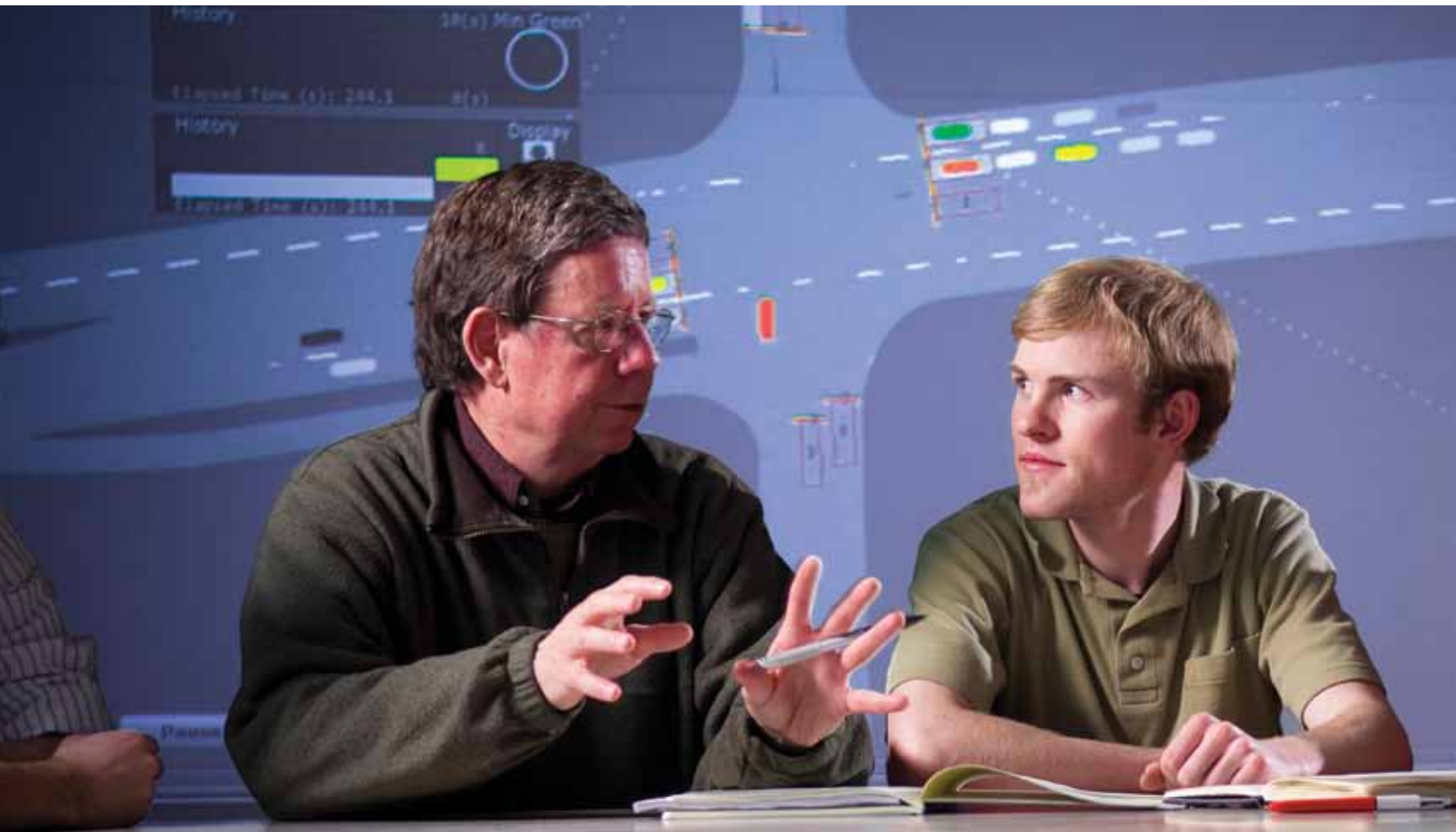

PREPARED FOR UNIVERSITY TRANSPORTATION CENTERS PROGRAM
RESEARCH AND INNOVATIVE TECHNOLOGY ADMINISTRATION
U.S. DEPARTMENT OF TRANSPORTATION

University of Idaho

FUNDING PERIOD JULY 1, 2010 THROUGH JUNE 30, 2011—FY11

THEME: Advanced Technology for Sustainable Transportation

Mission

Our mission is to develop engineering solutions (knowledge and technology) to transportation problems for the state of Idaho, the Pacific Northwest, and the United States, and to prepare our students to be leaders in the design, deployment, and operation of our nation's complex transportation systems.

Vision

Our vision is to be one of the premier transportation research and education programs in the United States.

- We are a national leader in developing technology to reduce congestion on arterials, improve the quality and economic viability of biofuels, and reduce the environmental impacts and improve the fuel economy of motorized vehicles (including passenger cars, transit vehicles, and recreational vehicles).
- NIATT faculty and students engage in multidisciplinary research to solve challenging, practical, and relevant transportation problems that have regional and national significance. We create interdisciplinary research and development teams of undergraduate and graduate students, mentored by expert faculty. To ensure our work is relevant and responsive to stakeholder needs, we seek collaborative partnerships with organizations such as the Federal Highway Administration, the Federal Transit Administration, the Idaho Transportation Department, and others committed to our values to work on problems of mutual interest. This practice engages our students in meaningful, experiential, learning-centered environments that add value to their education.
- By taking this approach, we integrate our research with the educational mission of the University. At the same time, our research results in technology that satisfies the needs of our customers, both by informing their actions and decisions and by providing them with useful products. We also provide life-long learning opportunities for transportation professionals in Idaho and the Northwest at all levels of practice.
- NIATT's work is carried out in the context of a commitment to preserving and protecting natural and pristine environments. Our research on, and development of, clean vehicles, alternative fuels, and efficient traffic control systems contributes to the sustainability of these environments.

On the cover:

Dr. Michael Kyte and civil engineering graduate student **Christopher DeLorto** discuss ideas for graphically displaying signal timing processes.

Bottom photos (left to right): **Amanda Bolland, Cody Brumett, Dylan Dixon, and Sonam Sherpa.**

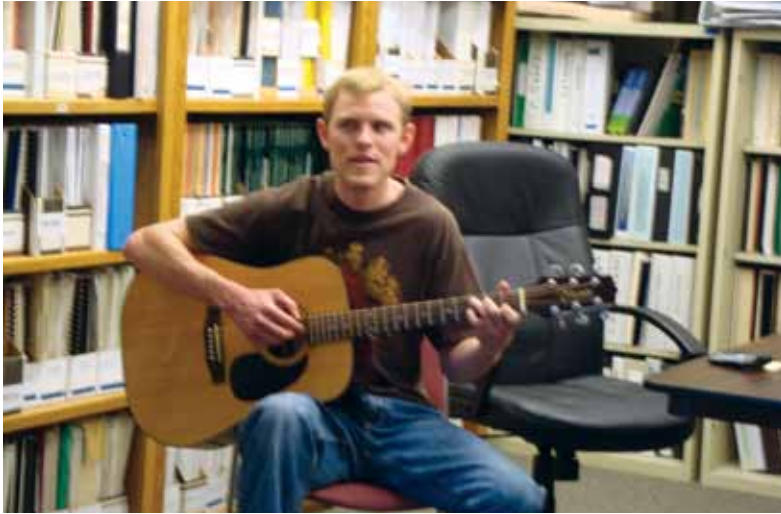

Christopher DeLorto said "thank you" to faculty and staff in NIATT with a few songs after completing his thesis.

Table of Contents

Director's Letter	2
Advisory Board	4
Management Structure	6
Affiliate Faculty	7
UTC Research	8
Education	32
Awards	35
Our Students	37
Future Students	42
Technology Transfer	43
Activities in the Region X Consortium	44
Financial Report	46
UTC Project Status	48

To access an electronic copy of this report and to read more about the research, education, and outreach activities of our students and faculty, we invite you to visit <http://NIATT.org>

National Institute for Advanced
Transportation Technology
University of Idaho
PO Box 440901
Moscow, ID 83844-0901

Telephone (208) 885-0576
Fax (208) 885-2877
Credits:
Tami Noble
Wendy Secrist

Director's Letter



Greetings from the National Institute for Advanced Transportation Technology (NIATT). At the time this report is being compiled, the future of the Department of Transportation's University Transportation Centers (UTC) program is unknown. It is possible that the program may be reorganized in the near future. An additional concern is the continuing weakness in the national and global economy. Economic development and job creation are nurtured by a strong transportation network and programs in workforce development, which are equally important for long-term economic stability. As I am completing my second year as director of the University of Idaho's NIATT, I am proud to be working with a group of faculty, staff, and students who contribute daily to developing solutions to national problems. Our emphasis remains on working with people and producing research results to improve transportation education, operations, infrastructure, and sustainability. People, and the end effects of our work in society, are the primary impetus for our work.

Transportation is a foundation for long-term economic recovery. Without a strong, flexible, and vibrant system, people cannot get to their jobs, goods cannot be delivered, and businesses cannot compete globally. Sustainability of the total transportation system is coming increasingly into focus. This includes not only urban/suburban planning concerns, but also the operation of our highway and street systems, manufacture and use of sustainable fuels, development of energy-efficient vehicles, and improvement of multi-modal transportation networks. Our researchers and students have always been focused on practical solutions to real-world problems, and the implementation of these solutions in the field, factory, and laboratory.

Our researchers and students continued their award-winning achievements this year:

- Our clean snowmobile team again achieved third place in the Clean Snowmobile Challenge, bringing back several other awards in the process, including Most Sportsmanlike.
- We have two patents pending, one in the continued development of the Advanced Accessible Pedestrian System for the vision impaired, and one for a synchronous charge trapping valve for a two-stroke engine that greatly improves power and fuel efficiency.
- NIATT researcher and Civil Engineering Associate Professor Ahmed Abdel-Rahim received the College of Engineering's Outstanding Faculty Award at the awards ceremony in May for an excellent record in teaching, research, and service.
- Richard Wall received the University of Idaho's Innovations Impacting Society Award at the Entrepreneurship & Innovation Celebration in April for his patented Advanced Accessible Pedestrian System for signalized traffic intersections.

"Transportation is a foundation for long-term economic recovery. Without a strong, flexible, and vibrant system, people cannot get to their jobs, goods cannot be delivered, and businesses cannot compete globally."

- Michael Kyte received the 2011 Teaching Excellence Award from the University of Idaho at the annual Excellence Awards in April. Dr. Kyte has a long history of outstanding contributions to university transportation education and research.
- **Randy Maglinao**, a 2011 PhD graduate in biological and agricultural engineering and NIATT research assistant, received the College of Engineering's Outstanding Graduate Student Award in May.

The 2010 Transportation Research Board's Traffic Signal Systems Committee meeting was held at the University of Idaho campus July 18–20, 2010. Former NIATT Director Michael Kyte worked diligently to prepare for the meeting, which was attended by 52 students and professionals in the traffic industry.

NIATT researchers continue to be guided by our theme of "Advanced Technology for Sustainable Transportation." In this report, you will see an emphasis on **Our Students**. We will introduce you to those who inspire us and make us eager to come to work every day. It would be impossible to accomplish our work without them. Student contributions make our university-based research unique. We teach and they learn, but we also learn while they accomplish great things!

We still believe in the principles as elucidated in our UTC vision statement:

"NIATT's work is carried out in the context of a commitment to preserving and protecting natural and pristine environments. Our research on, and development of, clean vehicles, alternative fuels, and efficient traffic control systems contributes to the sustainability of these environments."

Thank you for your support and involvement in our efforts.

Sincerely yours,



Karen Den Braven, Director

"NIATT's work is carried out in the context of a commitment to preserving and protecting natural and pristine environments. Our research on, and development of, clean vehicles, alternative fuels, and efficient traffic control systems contributes to the sustainability of these environments."

Advisory Board

Bruce Christensen
*Traffic Engineer, District 4
 Idaho Transportation Department*

James Colyar
*Highway Research Engineer
 Federal Highway Administration*

John Crockett
*Idaho Bioenergy Program
 Idaho Office of Energy Resources*

Gregory W. Davis
*Professor, Mechanical Engineering
 Kettering University*

Gary Duncan
*Sr. Vice President and Chief Technology Officer
 Econolite Control Products, Inc.*

Jim Evanoff
*Environmental Protection Specialist
 Yellowstone National Park*

Peter Koonce
*Principal Engineer
 City of Portland*

Tom LaPointe
*Retired
 Transit Director*

Jim Larsen
*Congestion Management Supervisor
 Ada County Highway District*

George F. List
*Professor and Head of Construction
 and Environmental Engineering
 North Carolina State University*

Paul Olson
*ITS Technology Engineer
 Federal Highway Administration*

Ned Parrish
*Research Manager
 Idaho Transportation Department*

Zong Tian
*Associate Professor, Civil and
 Environmental Engineering
 University of Nevada, Reno*

Jerry Whitehead
*President
 Western Trailers*



The advisory board banquet was a time for introductions and student presentations. Kari Dickinson (guest), Dan Cordon, Tom LaPointe (advisory board), and Jon Van Gerpen intently listen as Karen Den Braven, NIATT Director, welcomes everyone.



*Paul Zebell (City of Portland) discusses the virtual technology & design team's presentation with **Jake Lauer** (left) and **Bryan Foutch** (right).*

Annual Advisory Board Meeting

NIATT’s annual Advisory Board meeting was held over two days in April 2011, allowing the board members to attend and/or judge the annual University of Idaho Engineering Exposition held on Friday, April 29, 2011.

The Center for Traffic Operations and Control (CTOC) invited additional traffic professionals to attend the board meeting:

- Jim Bloodgood, Snohomish County, Washington
- Rob Klug, Clark County Public Works, Washington
- Paul Zebell, City of Portland, Oregon

Date	2011 ADVISORY BOARD AGENDA	
	Center for Traffic Operations and Control	Center for Clean Vehicle Technology
Wednesday, April 27	NIATT Banquet	
Thursday, April 28	Continental Breakfast Introductions/Agenda Overview Welcome, College of Engineering Dean, Don Blackketter	
	CTOC Project Presentations	CCVT Project Presentations
	Lunch	
	CTOC Board Discussions	CCVT Board Discussions
	Joint discussions; Synthesis of ideas Future of research at University of Idaho, Bill McLaughlin on behalf of Vice President for Research, Jack McIver Closing session: Next steps to take	
	College of Engineering Dean’s Reception	
Friday, April 29	Engineering Expo	

On Wednesday, April 27, 2011, NIATT held a banquet to welcome board members and other guests. **Dylan Dixon**, NIATT’s 2010 Student-of-the-Year and MS candidate in mechanical engineering, and Michael Kyte’s virtual technology & design

team, **Bryan Foutch**, **Devin Abolins**, and **Jake Lauer**, made presentations on their experiences working in NIATT and their current project work.

On Thursday, the meeting was in full swing with presentations throughout the day by NIATT researchers seeking funding for the 2011–2012 academic year. The board members interacted with presenters and made recommendations for funding for the next fiscal year.



Members of the advisory board and NIATT principal investigators discuss specifics of presentations. From right to left: Dan Cordon, Jerry Whitehead (advisory board), Tom LaPointe (advisory board), Judi Steciak, Armando McDonald, and Steve Beyerlein.

Management Structure

The National Institute for Advanced Transportation Technology (NIATT) is one of six research institutes on the University of Idaho campus. Institute status was granted to NIATT in July 1998 in recognition of its university-wide, multi-disciplinary activities. The institute, originally known as NCATT, was established in 1991 under the Intermodal Surface Transportation Efficiency Act (ISTEA).

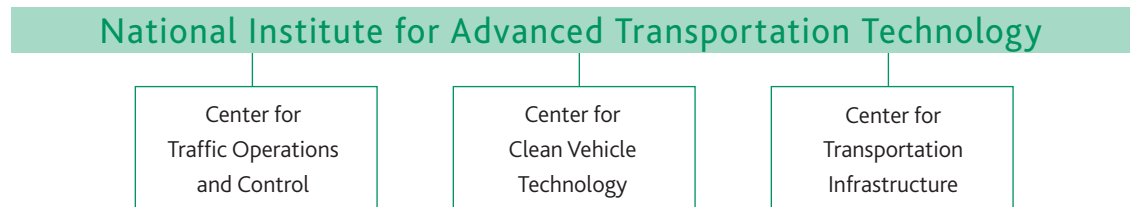

Although the University Transportation Centers (UTC) program primarily supports the work of NIATT's Center for Traffic Operations and Control and the Center for Clean Vehicle Technology, the UTC funding has a positive impact on the entire institute and our ability to deliver transportation technology. UTC funds are supplemented from a variety of sources, including the Idaho Transportation Department (ITD), Idaho Department of Water Resources, the U.S. Departments of Energy and Defense, and the Federal Highway Administration. The research in the Center for Transportation Infrastructure is supported mainly by the cooperative agreement between NIATT and ITD.



*Karen Den Braven
Director, NIATT
Professor, Mechanical
Engineering*



*Tamara Noble
Assistant to the
Director, NIATT*



*Deborah Foster
Financial Technician,
NIATT*



*Victor House
ITS Integration
Analyst, NIATT*



*Wendy Secrist
Research Writer,
NIATT*



*Dan Cordon
Development
Engineer, NIATT*



Josh Ulrich, Sam Wos, and Brett Bashford discuss aspects of the formula hybrid car at the NIATT end-of-semester celebration in May.

Affiliate Faculty

John Anderson <i>Assistant Professor, Virtual Technology & Design</i>	Brian Johnson <i>Chair, Electrical and Computer Engineering</i>
Ahmed Abdel-Rahim <i>Associate Professor, Civil Engineering</i>	James Kingery <i>Professor Emeritus, Range Resources</i>
Denise Bauer <i>Assistant Professor, Mechanical Engineering</i>	Axel Krings <i>Professor, Computer Science</i>
Fouad Bayomy <i>Professor, Civil Engineering</i>	Michael Kyte <i>Professor, Civil Engineering</i>
Steven Beyerlein <i>Professor, Mechanical Engineering</i>	Joseph Law <i>Professor, Electrical and Computer Engineering</i>
Ralph Budwig <i>Professor, Mechanical Engineering Director, Boise Engineering</i>	Michael Lowry <i>Assistant Professor, Civil Engineering</i>
Anthony Davis <i>Assistant Professor, Forest Resources</i>	Richard J. Nielsen <i>Chair, Civil Engineering</i>
Karen Den Braven <i>Professor, Mechanical Engineering</i>	Edwin Odom <i>Professor, Mechanical Engineering</i>
Michael Dixon <i>Associate Professor, Civil Engineering</i>	Judi Steciak <i>Professor, Mechanical Engineering</i>
Brian He <i>Associate Professor, Biological and Agricultural Engineering</i>	Jon Van Gerpen <i>Chair, Biological and Agricultural Engineering</i>
	Richard Wall <i>Professor, Electrical and Computer Engineering</i>



Dr. Richard Wall talks with Paul Zebell (City of Portland) and Rob Klug (Clark County Public Works) about his new proposal during a break at the 2011 Advisory Board Meeting.

UTC Research

As do all University Transportation Centers, NIATT uses its strategic plan to set the framework for research selection and implementation. NIATT's most recent strategic plan, approved in 2007 by US DOT, describes four objectives, two of which are directly related to research:

Objective 1: Develop arterial traffic management tools that can be used by practitioners and researchers to manage congestion and improve safety.

Objective 2: Improve the quality and economic viability of biofuels, and reduce the environmental impacts and improve the fuel economy and safety of motorized vehicles (including passenger cars, transit vehicles, and recreational vehicles) to protect the natural and built environment.

Objective 1 directs the research activities of NIATT's Center for Traffic Operations and Control (CTOC), while Objective 2 guides the research for NIATT's Center for Clean Vehicle Technology (CCVT).

The strategic plan outlines several strategies under each objective of the strategic plan, defining the way we plan to meet those objectives.

For this annual report, each principal investigator (PI) was asked to describe how the students are contributing to their project, focusing on who the students are (e.g., major and current standing), and what work they are doing (or did, if they are no longer working on the project). The PI also summarized the progress on the project to date.

The research conducted at NIATT relies on the knowledge and strengths of the researchers. Each project involves both graduate and undergraduate students, who have the opportunity to conduct basic and/or applied research, the products of which are judged by experts, contributing to the body of knowledge in transportation while earning their degrees.

Student Highlights on Projects

Center for Clean Vehicle Technology

Project: Aqueous Ethanol Ignition and Engine Studies, Phase II (KLK762)

Student Involvement: Pietro Boyd, Jason Cyr, Duane Elgan, Brad McGary, David Mehaffey (graduate students, mechanical engineering); Chad Barnes, Tyler Merritt, Paul Sowinski (undergraduate students, mechanical engineering); Kevin Oswald, Emanuil Yanev (summer interns)

Principal Investigator: Dr. Judi Steciak

Co-Principal Investigators: Dr. Steven Beyerlein and Dr. Ralph Budwig

University Transportation Center Funding: \$92,615

During the second year of this project, we used our new heavy fuel evaporator and second plug-flow reactor to expand the range of catalysts, alternative biofuels, and ethanol-oxygen mixtures that we can test. In our engine laboratory, we used our Cooperative Fuel Research (CFR) engine to test an igniter we designed and fabricated on-site, and installed a dilution tunnel/TEOM purchased with another grant. We continued to make our laboratories available to other researchers and instructors in the Center for Clean Vehicle Technology.

Our heated plug flow reactors were used to study the reactions of nonflammable mixtures of canola methyl ester-oxygen and soybean methyl ester-oxygen diluted with nitrogen over a coiled 90%:10% platinum:rhodium (Pt-Rh) wire catalyst. We also tested ethanol with Pt-Rh because this catalyst has improved high temperature stability in comparison with pure platinum. To test liquid fuels, we designed and built an evaporator capable of providing steady fuel vapor at the low flow rates (on the order of microliters per hour) required by the reactors. Light-off temperatures and the energy generated by surface reactions were obtained. These data will help verify engineering models under development for accelerating Catalytic Plasma Torch (CPT) designs for different engine platforms.

The process for designing and fabricating the CPT on the University of Idaho campus was established. In past engine testing with CPT technology, the University of Idaho has witnessed promising results in the reduction of NO_x and CO emissions. The past research has indicated that with more parametric studies of the CPT design, more control over the combustion event can be achieved. CPT construction techniques developed by Automotive Resources,

Inc. (ARI) were used as a baseline for the next generation design and fabrication process outlined in this work. The design was improved by making the prechambers interchangeable with the feedthrough and catalytic core assembly. The feedthrough was simplified by using a compression style cap made by Conax® Technologies. Testing with the CFR engine shows that the redesigned CPT can successfully withstand combustion pressures and facilitate gas phase ignition as effectively as the ARI design. With the new design and simplified fabrication process, families of CPT assembly combinations can be locally and inexpensively produced for use in parametric ignition studies.

Outcomes of this work included: 1) key information (light-off temperature and heat generation rate) needed for engineering timing models used to optimize igniter design; 2) specifications for in-house igniter design and fabrication; and 3) infrastructure improvements that enhance our competitiveness in state and federal funding programs.

Jason Cyr (2011 MSME graduate) and **Pietro Boyd** (graduate student, mechanical engineering) have been collaborating on a process for local fabrication and testing of CPT designs. The new design proposed by Jason and undergoing refinement by Pietro is conducive to more parametric studies surrounding key CPT design variables. Testing with the single-cylinder, variable compression CFR engine in the Small Engine Laboratory shows that the redesigned CPT can successfully withstand combustion pressures and facilitate gas phase ignition as effectively as the previous design that was externally produced by ARI in Sandpoint, Idaho. This new capability will accelerate our implementation of catalytically supported ignition as a method for successfully burning alternative fuels in engines originally designed for gasoline and for diesel. Jason is now employed by General Motors at their proving ground in Michigan. Pietro plans to graduate in the spring of 2012 and would like to pursue a career in the motorsports industry.

Brad McGary (2011 MSME graduate), **David Mehaffey** (2011 MSME graduate), **Duane Elgan** (graduate student, mechanical engineering), **Kevin Oswald** (undergraduate student, mechanical engineering), and **Emanuil Yanev**



Duane Elgan in the Combustion Laboratory in Boise.

(Treasure Valley Mathematics and Science High School senior volunteer) have been taking a more detailed look at the interaction between fuel mixtures and catalytic surfaces. They have used a plug-flow reactor to measure the light-off temperatures of biodiesel (both soy methyl ester and canola methyl ester) and ethanol on pure platinum and 90%:10% platinum:rhodium catalysts, and obtained the energy generated due to surface reactions. These experiments required designing and testing an evaporator to steadily vaporize liquid fuels and heating the reactor to maintain the fuels as vapor. Duane will be extending our ability to completely model surface reaction chemistry and has gathered baseline data using methane and platinum in anticipation. These activities will aid in the development of engineering models to accelerate the development of CPTs for different engine platforms. Brad is now working for an energy analysis and conservation company in Jacksonville, Florida. David was hired by Hewlett-Packard in Vancouver, Washington. Duane expects to graduate in 2012 and is interested in a new engine design being developed by a family business.

Chad Barnes, Tyler Merritt, and Paul Sowinski (undergraduate students, mechanical engineering) were NIATT interns. As part of their internship, they helped maintain and improve the Small Engine Laboratory and the Vehicle Laboratory. Chad was responsible for designing and assembling an engine platform that will be used to train new users in the dynamometer facility. This included the precision mounting of an engine and the design/manufacture of an adapter for the dynamometer driveshaft. Paul and Tyler were instrumental in making several upgrades to the Small Engine Laboratory, including building a sturdy workbench, constructing shelving in the fuel room, and organizing items like funnels and oil pans in a way that keeps them clean and ready for use. All the NIATT interns were helpful during engine dynamometer testing, creating special fixturing when required and keeping the labs in a clean and organized state. Chad, Tyler, and Paul graduated with their BSME from UI in 2011.

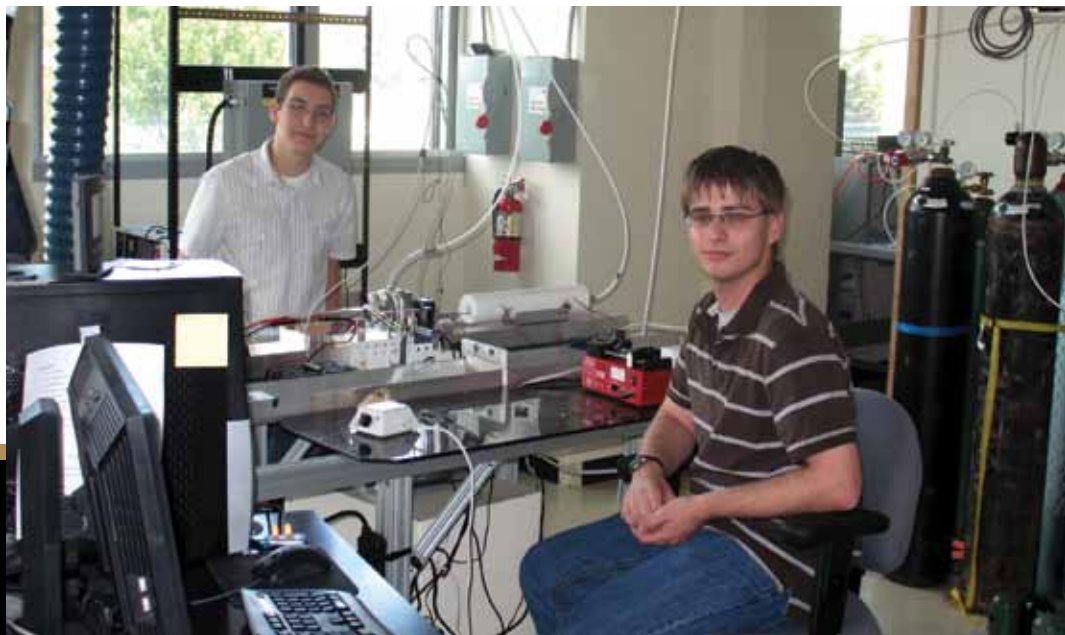

Emanuel Yanev (left) and Kevin Oswald in the Combustion Laboratory in Boise.

Project: Development of a Low-Speed, Two-Stroke, Direct-Injection Snowmobile for Use in the Clean Snowmobile Challenge and National Parks (KLK763)

Student Involvement: Dylan Dixon, Austin Welch, Parley Wilson (graduate students, mechanical engineering); Alex Fuhrman, Neil Miller, Jeremy Nichols (undergraduates, mechanical engineering); Sam Smith (undergraduate, PTTE-technology education option); Joel Frazier (high school intern).

Principal Investigator: Dr. Karen Den Braven

University Transportation Center Funding: \$83,796

Due in part to stringent noise and air pollution control measures imposed on snowmobiles by the Environmental Protection Agency (EPA) and the National Park Service, the Society of Automotive Engineers (SAE) instituted a student competition called the Clean Snowmobile Challenge (CSC) in 2000. The University of Idaho, NIATT-supported, Clean Snowmobile Challenge Team (UI CSC) first competed in the CSC in 2001. SAE sponsored competitions are an excellent and popular educational tool in engineering programs because they promote a positive, hands-on working environment for students.

Students

This year the team consisted of two graduate student mentors and 15 undergraduate students. The team also sponsored two mechanical/electrical engineering senior design projects, which involved six engineering seniors. One team developed an innovative (patent pending) exhaust valve for a two-stroke engine that improves power and fuel economy by 15–30%. The other team developed a muffler system that incorporates an emissions catalyst and reduces noise from the snowmobile. Students on the CSC team learn not only how to solve a technical problem, but also the value of teamwork and leadership. They must learn to balance the competing requirements of fuel economy, engine power, noise and pollution reduction, handling, and consumer acceptance. A portion of the score in the CSC is based on both written and oral communication skills. Students learn the importance of proper communication with everyone—from a manufacturer, to a snowmobile racer, to a land manager, or to a child who is interested in having fun on a snowmobile. The competitions are open to the public, and manufacturers spend time visiting the



Dylan Dixon on the Acceleration portion of the Clean Snowmobile Challenge in 2010. (Photo courtesy of MTU/KRC)

student teams and observing what the students have done. Students often receive internship and permanent job offers from this experience. In addition, the National Park Service, SAE, and EPA closely watch the results of the student sleds while developing potential performance requirements for snowmobiles in sensitive regions.

On the strength of its students, the UI CSC team has excelled in the competition. In addition to winning first place in 2002, 2003, and 2007, the team has also achieved an overall second place in 2008, and third place in 2009, 2010, and 2011. The team has also been awarded over 60 trophies, such as Best Fuel Economy, Best Value, Best Ride, Quietest Snowmobile, Best Acceleration and Handling, and Most Sportsmanlike Conduct over ten years of competing.

Graduate Students

This year both of the graduate student mentors had been members of the team as undergraduates, one for his entire undergraduate career.



Those who watch the NIATT website are probably familiar with **Dylan Dixon's** name. Dylan was captain of the snowmobile team for two years as an undergraduate student, and was the NIATT Student-of-the-Year this year, receiving his award at the Council of University Transportation Centers (CUTC) banquet at TRB in January 2011. Dylan had an internship at Bombardier Recreational Products in Waukegan, Illinois this past summer, where he was troubleshooting direct injection systems for two-stroke engines. Dylan is expected to complete his master's degree in December 2011, with a research emphasis on the effects of a guillotine-type valve in the exhaust stream of a two-stroke engine.



Austin Welch is more of a Johnny-come-lately to the team, having spent only one year on the team as an undergraduate. He has proved to be a tremendous asset, assisting the exhaust valve senior design team in their patent-pending design. He will complete his master's degree in May 2012, having focused on studying the effects of the synchronous charge trapping exhaust valve design.

Undergraduate Students

The CSC team is unique in that it is primarily an undergraduate student driven project. Students learn not only technical solutions, but also project management and budgeting skills. The success of the UI CSC over the years is due primarily to the structure of the team, in which graduate students mentor upper-class students, who in turn teach the new students on the team. Legacy knowledge is the keystone. This year a large number of experienced students graduated, including several former team captains. We wish them well in all of their new efforts.

The Team

The team continued the development of the two-stroke direct-injected snowmobile engine that began in 2006. The original technical challenges included proper design on the cylinder head and developing precise electronic control of the fuel pump and injectors. Direct injection can lessen the effects of charge and exhaust gas mixing, and significantly reduces short-circuited fuel. In a gasoline direct-injected engine, fuel is injected into the cylinder when the exhaust ports are nearly or completely closed. Air-assisted or high pressure fuel injectors are used to ensure that the fuel atomizes quickly for combustion.

In March 2007, the UI CSC team brought home first place and nine other awards. Throughout the 2007 CSC, NIATT snowmobiles used E10 as a fuel. E10 is a blend of 10 percent ethanol mixed with 90 percent gasoline.

In 2008, the teams were required to use an E85 blend. The UI team improved the combustion chamber to reduce exhaust emissions and improve fuel efficiency. It was rewarded with overall second place and five additional trophies including a best paper award.

In 2009, competing snowmobiles were required to be flex-fuel, that is, able to run on any ethanol/gasoline blend from E10 to E85. The composition was varied several times throughout the competition from E11 to E55. For 2009, the UI team was unable to program the direct injection system for flex-fuel, so the team instead moved to the slightly less efficient semi-direct injection (SDI) system. The team was able to achieve performance results nearly as good as that of a direct-injection engine. The UI CSC team achieved overall third place, also achieving Best Fuel Economy, Best Acceleration, and Best Value.

In 2010 and 2011, the competition used only one fuel, which was an unknown ethanol/gasoline blend between E20 and E29, similar to what is proposed as a future requirement for passenger cars. Each year the UI CSC achieved overall third place, with additional trophies in 2010 for Cold Start, Best Acceleration, Best Handling, and Best Ride, and in 2011, Best Ride, Best Value, Cold Start, and the Founder's Trophy for Most Sportsmanlike Conduct for extinguishing a fire on a competitor's snowmobile. The team's snowmobile passed all events in the competition—one of only two snowmobiles to do so.

Results and the Future

The University of Idaho Clean Snowmobile Challenge team has made significant technological advances in engine technology in the last nine years, improving the fuel economy and reducing the pollution and noise emissions from the engines used in snowmobiles. Future plans include continuing to explore the use of alternative fuels in snowmobiles. The direct injection technology looks like it's here to stay in small, recreational engines. The next frontier in the competition is sound reduction. The National Park Service sound reduction requirements are stringent. Even four-stroke powered snowmobiles have difficulty meeting that requirement without a significant modification in performance, typically requiring detuning. A snowmobile that needs no modification to be allowed to run anywhere would be a boon to the snowmobile industry, especially to outfitters whose clients may or may not be planning on accessing sensitive National Parks.



The UI CSC team prepares for competition in Houghton, Michigan in March 2011.

Project: Design Synthesis, Manufacturing, and Testing of a Competitive Hybrid FSAE Vehicle (KLK764)

Student Involvement: Brandon Butsick, Tyler Flowers, Stefan Hovik, Cameron Stefanic, Sam Wos (graduate students, mechanical engineering); Brett Bashford, Chris Douglas, Josh Ulrich (graduate students, electrical and computer engineering); Corey Adrian, Cody Brumett, Chris Eacker, Joshua Foss, Alex Hanson, Stephen Heib, Bobby Jackson, Zack Porter, Dylan Rinker, Nathan Repp, Justin Ruegsegger (undergraduate students, mechanical engineering); Kevin Roos (undergraduate student, computer engineering)

Principal Investigator: Dr. Edwin Odom

Co-Principal Investigators: Dr. Steve Beyerlein and Dr. Joe Law

University Transportation Center Funding: \$80,130

The 2010–2011 Formula Hybrid Vehicle team made several accomplishments to be built upon by the 2011–2012 team. Next year's team will have new members, and some of the old members will move into mentoring positions while some of the younger members will step up to senior design. The team has finished all design work and modeling, with only the toils of manufacturing left before them.

In addition to being the overall team leader, **Zack Porter** has also taken responsibility for tuning and fuel injecting the car's engine. This has become a very impressive and difficult task because it is the first of its kind. Using two custom-designed and built sensors and the best vehicle electronic control unit (ECU) in the world, Zack is working to get as much power out of this engine as is safely possible. The custom-designed engine case is being polished and perfected and is near ready to be tested. Currently all interior components are going through the process of being dry fit into the case before the final build. The electronic fuel injection (EFI) testing for the engine is moving smoothly and a few of the team members will be taking the class EFI 101, which is a 4-day long course taught by professionals in the area of electronic fuel injection tuning.

The frame and suspension geometry from last year's team will be used again, but the physical components for the suspension are going through some alterations to reflect the change from a pushrod suspension to a pull rod. A rolling chassis is expected to be finished by the end of July 2011.



Zack Porter is preparing to reattach the valve cover to the top of the engine. This cover holds one of the two sensors necessary to run the engine with a fuel-injected system.

The electrical system has moved forward at a steady pace thanks to efforts from electrical and computer engineering (ECE) undergraduate **Kevin Roos**, and ECE graduate students **Josh Ulrich**, **Brett Bashford**, and **Chris Douglas**. Kevin worked on the dash and user interface as part of his capstone design project, and he graduated with his BS from UI in 2011. Josh, Brett, and Chris have been making great progress on the hybrid-electric system of the car. Their projects include creating a comprehensive data acquisition system, implementing battery management, and programming the control system for the electric motor. They are also handling all wiring to the dashboard, battery boxes, and electric motor/controller. Josh has created many of his own sensors, such as the accelerometers. The accelerometers will be attached to all four wheels so we will be able to see how much force and acceleration all four corners of the car experience during a given lap of the track. Brett and Chris have been experimenting with battery layout, performance testing, and programming for the battery monitoring system.

Currently the battery boxes are finished and mounted to the frame. One key and very unique aspect of the Formula Hybrid Society of Automotive Engineers (SAE) Car project is that it brings together students from several disciplines. For example, in order for these battery boxes to be successful, it took the effort of four students majoring in mechanical, electrical, and computer engineering. These boxes must meet strict competition safety guidelines and hold eight lithium-ion batteries, two fuses, an electric relay, several extremely large wires, and two charging nodes. Complete testing of the batteries will be done by the end of July 2011 and dry fitting of the electrical components will begin once testing is complete.

The body work for the car halted to a standstill when the team ran into adhesive problems during the spring 2011 semester, but plans have been made to continue and finish the work before the end of 2011.

The car will be ready for the May 2012 formula hybrid competition. The rules for the competition will be released in September 2011. The team will have ample time for testing and possibly redesign of some of the car components if required by the competition rules.

Not only does the team work together to complete the formula hybrid car, but each member also has an area of responsibility. **Stephen Heib** is responsible for the fuel system, engine management, and manufacturing. **Nathan Repp** is responsible for exotic material frame design and construction, and he is the SAE treasurer. **Zack Porter** is

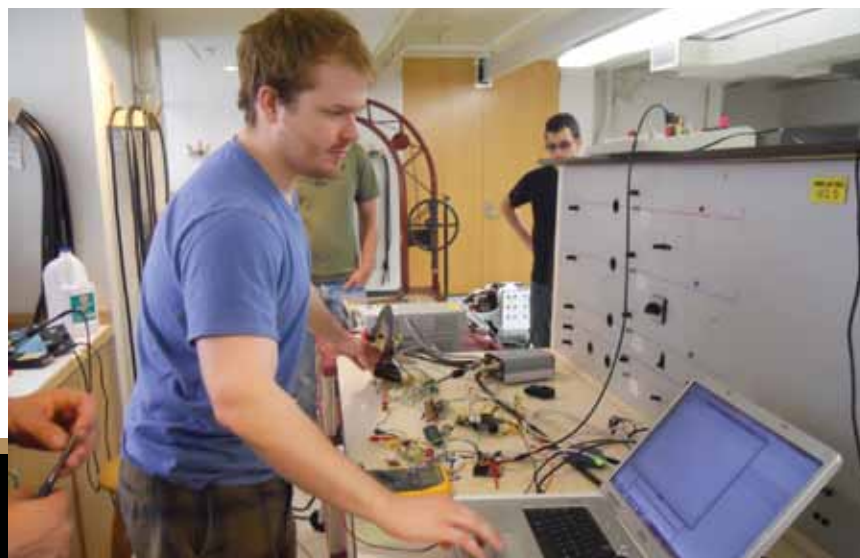

Josh Ulrich is demonstrating the different preset modes the car can be put in. These modes include electric drag race, hybrid drag race, and endurance race, as well as automatic, retrieve data, and test mode. Josh has developed an ingenious setup where the driver of the car can make any of these adjustments while sitting in the car.

the team lead and SAE president. He is also responsible for the engine tuning and manufacturing odds and ends. **Corey Adrian** is the braking and steering lead. **Cody Brumett** is responsible for battery storage, wiring, and cooling systems. Cody is also a NIATT intern. **Chris Eacker** is responsible for the suspension design, data acquisition, and manufacturing. **Dylan Rinker** is responsible for the drive train. **Bobby Jackson** is the webmaster, and he is also responsible for helping integrate systems, welding, and manufacturing odds and ends. **Justin Ruegsegger** is responsible for engine management and the fuel system. **Joshua Foss** is SAE secretary, and is also responsible for the firewall, the seat, and human factors analysis and design. **Josh Ulrich** is responsible for the electrical control system. **Tyler Flowers** is responsible for suspension and frame design. **Sam Wos** is the graduate technical director and machine shop mentor. Josh, Tyler, and Sam are graduate research assistants for NIATT.

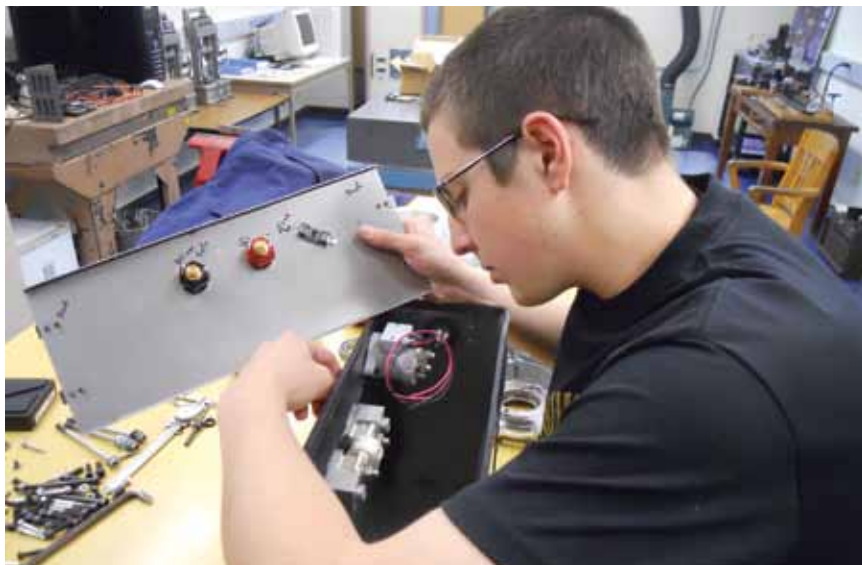

Cody Brumett mounting the high-voltage components into the battery storage containers.



The 2010–2011 Hybrid Team (left-to-right) **Stephen Hieb**, **Nathan Repp**, **Zack Porter**, **Corey Adrian**, **Cody Brumett**, **Chris Eacker**, **Sam Wos**, **Dylan Rinker**, **Bobby Jackson**, and **Justin Ruegsegger**.

Project: Continuous-Flow Reactor System for Improved Catalytic Glycerol Conversion (KLK765)

Student Involvement: Randy Maglinao (PhD graduate student, biological and agricultural engineering); Sushant Kshetri, Sonam Sherpa (undergraduate students, chemical and materials engineering)

Principal Investigator: Dr. Brian He

University Transportation Center Funding: \$55,001

Converting surplus low-quality glycerol (a by-product from biodiesel production) to valuable products remains a hot topic in both the industry and research communities. Our previous research showed improved ethanol yields by applying the Raney nickel catalyst. With these promising results, further investigation was recommended to improve the productivity and yield using a continuous-flow reactor system. Compared to batch processes, a continuous-flow reactor typically provides better unit productivity, more consistent product quality, and much-improved process efficiency since the frequent heating and cooling in batch processes are eliminated, reactions occur under optimized conditions, and the products are collected continuously. Therefore, it is worthwhile to conduct a study of catalytic conversion of glycerol to valuable products in a continuous-flow reactor system, which is also a necessary step of technology development. This report summarizes the results of the testing attempted to improve the efficiency of glycerol processing.

A continuous-flow reactor system was modified from the existing 300 mL PARR bench scale batch reactor system and used for conducting this research. Aqueous glycerol was pumped continuously to the reactor system using a high-performance liquid chromatography (HPLC) pump, and the condensable product was collected in a high-pressure vessel after a high-pressure condenser. A fed-batch reactor system using the same PARR reactors was also designed and used for testing. With the continuous-flow reactor system under the conditions of 220°C, 1:1 water-to-glycerol mass ratio and 30 mL/min feeding rate, liquid product was successfully collected in the receiver vessel. However, analysis of the liquid product showed small amounts of methanol and ethanol. Further investigation revealed that the major component in the liquid product was water, which we hypothesized was the result of reformation reactions such as water-gas shift reaction. With the fed-batch system, a slight improvement in the ethanol yield, approx. 3.5%mol, was observed.



Randy Maglinao using the modified continuous-flow reactor system.



Sonam Sherpa analyzing the gaseous products using Draeger gas detection tubes.

In summary, the continuous-flow reactor converted from the batch reactor vessels was not able to produce alcohols with high yields as expected. A relatively large head space in the reactor may have caused the reaction to favor gaseous products. Despite the less-favorable results of process efficiency and alcohol yields from this study, it is still strongly recommended to further investigate the applicability of a continuous-flow reactor system for this process using a different design, such as the tubular reactor that is under pre-experimental testing by our research team.

Randy Maglinao (2011 PhD graduate in biological and agricultural engineering) was in charge of managing, designing, and conducting the experiments, and drafting this report. He also directly supervised two undergraduate students, **Sonam Sherpa** and **Sushant Kshetri**, who assisted him in data collection and experimental operations.

The research project gave Randy the opportunity to integrate his education in chemistry, engineering, and biology with scientific research in bioenergy and biorefinery. The experiences acquired from this research project will prepare him for his professional career growth as a scientist and engineer in his field. Supervising undergraduate students in conducting the experiments helped him to acquire management skills that will be beneficial for his future occupation as a research scientist, faculty, or a project leader in the field of biological and agricultural engineering. It also gave him the opportunity to learn the skills to plan and execute experiments and other tasks for the purpose of completing a project and achieving its goals in a specified time period. This research has provided him the experience of holding lectures in class and writing technical papers and presenting them through oral and poster presentations in professional technical conferences.

Sonam Sherpa and **Sushant Kshetri** (undergraduate students of chemical and materials engineering) learned the proper techniques and methods in handling chemicals and conducting experiments in a laboratory. They became skilled in using common laboratory equipment for both qualitative and quantitative analysis that would be beneficial in their studies and senior design/research projects. This research project also provided them with knowledge of the applications of theories that they learned in their classes—such as chemical reactions, thermodynamics, and chemical structures—to real-world problems in bioenergy and biorefinery.



Sushant Kshetri preparing samples for GC analysis.

Project: Production of Renewable Diesel from Biologically Based Feedstocks (KLK766)

Student Involvement: Keegan Duff (graduate student, biological and agricultural engineering); Carlo Munoz-Lopez (PhD student, biological and agricultural engineering); Sonam Sherpa (undergraduate student, chemical and materials engineering)

Principal Investigator: Dr. Jon Van Gerpen

Co-Principal Investigator: Dr. Brian He

University Transportation Center Funding: \$70,001

One of the biggest problems of the 21st century is linked with eventual depletion of fossil fuels, growing ambient air pollution, and urgent concern about climate changes occurring because of increased CO₂ emissions and global warming. Governments have responded to such problems and have taken actions, such as new fuel economy and emission standards. The use of "clean" and renewable fuels may be the key to overcoming emission regulations without significant changes to engine efficiency and fuel economy.

Biodiesel fuel is produced from renewable resources like vegetable oil or animal fat; it is biodegradable and has beneficial effects on exhaust emissions when compared to diesel fuel, and has been used in compression ignition (CI) diesel engines without any engine modification for decades. Its effectiveness as a diesel fuel substitute is well established. The poor cold flow, oxidation stability, and oxygen content of biodiesel prevent it from being used as aviation fuel.

Renewable diesel is produced from the same renewable resources as biodiesel but undergoes a different treatment called "hydro-cracking," which produces a molecule similar to biodiesel but deoxygenated, which has higher cetane, oxidation stability, and can stay liquid at lower temperatures than biodiesel, making it suitable for aviation fuel. Vegetable oils or animal fats are reacted with hydrogen under high temperature, usually between 570°F and 750°F, and at pressures above 600 psi, in the presence of a metal catalyst to undergo a series of reactions in order to become a premium biofuel.



Clean hydrogenated and deoxygenated fuel is solid but transparent when liquid.

For the past year, the University of Idaho has been working to develop a process to produce renewable diesel and bio-jet fuel. We have been using a solid catalyst known as Raney nickel, mostly used for the hydrogenation of vegetable oils in industrial processes, with very promising results. In order for oil or fat to become renewable diesel, it must first be hydrogenated, which means that the unsaturated fatty acids have to be saturated with hydrogen, turning the liquid oil into a solid fat with a melting point of around 160°F. After the hydrogenation, the oil must be deoxygenated, which means that all of the oxygen is removed from the fatty acid, producing straight chain paraffin, which makes a perfect fuel for diesel engines due to its similarities with cetane.

At this point, we have improved the cold flow properties of the fuel by reducing its melting point from 160°F to around 70°F. But it is still far from the pour point of diesel fuel, which is around 15°F. Therefore it must undergo isomerization, which causes branching with methyl groups so the fuel is no longer a straight chain hydrocarbon. This makes it difficult to crystallize at low temperatures, keeping it liquid at lower temperatures. Tests to optimize isomerization are currently underway.

Carlo Muñoz (PhD student in biological and agricultural engineering) is working to develop the procedure to produce renewable diesel from vegetable oils. **Sonam Sherpa** (undergraduate student in chemical and materials engineering) is supporting Carlo in his work by being responsible for doing the reactions and operating the batch processor. **Keegan Duff** (2011 MSBAE graduate) helped develop a technique to measure the alkanes produced by the hydrotreatment.



Sonam Sherpa watches as Carlo Muñoz removes Raney nickel catalyst from the renewable diesel sample after the reaction.

Center for Traffic Operations and Control

Project: An Architecture for Implementing Improved Queue Spillback Control Strategies (KLK717)

Student Involvement: Mohammad Rabiul Islam, Kevin Kingsbury, Syed Zillur Rahman, Golam Sarwar, Asma Tuly (graduate students, civil engineering); Justin Clark, Kenneth Wadley, Sean Wagoner (undergraduate students, electrical engineering)

Principal Investigator: Dr. Michael Dixon

Co-Principal Investigators: Dr. Ahmed Abdel-Rahim and Dr. Richard Wall

University Transportation Center Funding: \$173,796

Introduction

NIATT researchers intend to accelerate development in traffic systems performance monitoring and control strategies by improving researcher access to traffic signal control system hardware. Previously, a small, inexpensive microprocessor was employed to query a controller's database and request changes to its control parameters. This system retrieves controller data to calculate performance measures, such as green utilization, volumes, and queue spillback. In addition, the system uses these performance measures to determine if a change in controller parameters is necessary, determine the parameter values needed, and send the parameter values to the controller.



Traffic controller network in the NIATT computer lab.

Approach

Recent developments created a system that can retrieve controller data, estimate performance measures, and more. It can now communicate with a system of traffic controllers to monitor and control multiple intersections in a coordinated fashion. Tests to determine the size limitations are currently underway. Future efforts will expand queue spillback control algorithms to include performance monitoring and control modifications at several intersections. In addition, microcontroller code will be opened to researchers with the documentation of the steps researchers need to follow to employ this system to support their research in the areas of traffic system performance monitoring and control strategies.

Implications

Researchers will have more realistic test environments, making it more efficient to develop traffic system performance monitoring techniques and control strategies. One important element of this realism is that the prototype performance measures and control strategies must rely on data they receive from traffic controllers. Because of this reliance, traffic controller manufacturers can more readily integrate these measures into their existing systems.

Mohammad Rabiul Islam programmed and tested the Rabbit microprocessor to manage a network of traffic controllers. The device gathers data from the controller network; compiles performance measures such as queue length, traffic volumes, and wasted green time; evaluates the intersection operations; and changes the control strategy used by the controllers.

Kevin Kingsbury collected field data and helped create a microsimulation model of the field.

Syed Zillur Rahman and **Golam Sarwar** investigated using Bluetooth probe vehicles to measure signalized intersection performance to better inform traffic control strategy decisions. Methods from their efforts resulted in performance measures that improve an engineer's ability to progress traffic through a system of signalized intersections.

Asma Tuly developed improved automated methods to detect when the traffic queue cleared the stop bar. This can be used to more accurately determine how much green is wasted. If too much green is wasted, then traffic controller settings can be changed to serve traffic more efficiently.



Mohammad Rabiul Islam, graduate student in civil engineering

Justin Clark, **Kenneth Wadley**, and **Sean Wagoner** supported civil engineering graduate students by investigating different methods to build a network of traffic controllers that are managed by external hardware devices, such as Rabbit microprocessors.

Project: Using Visual Tools and Learning Outcomes-Based Curriculum to Help Transportation Engineering Students and Practitioners to Better Understand and Design Traffic Signal Control Systems (KLK718)

Student Involvement: Samantha Campbell, Christopher DeLorto, Jorge Jordan-Zamalloa, David Sherman (graduate students, civil engineering); Devin Abolins, Bryan Foutch, Jacob Lauer (undergraduate students, virtual technology & design)

Principal Investigator: Dr. Michael Kyte

Co-Principal Investigator: John Anderson

University Transportation Center Funding: \$110,212

TrafficSense: Using Visualization to Learn About Traffic Signal Control Systems

One of the most powerful ways for students to learn about engineering processes or systems is through visualization. Since September 2009, teams of students from the University of Idaho's Departments of Civil Engineering and Virtual Technology & Design (VTD) have worked together to develop tools and example curricula that will enable transportation engineering students to more effectively learn about traffic signal control systems. During the past two years, the teams developed a series of prototypes that provided unique ways of visualizing processes that operate simultaneously: traffic flow patterns, traffic detectors, signal timing processes, signal displays, and performance measures. The teams focused their work on four control types: standard actuated traffic control, volume density control, signal coordination, and railroad preemption.

During spring 2010, as part of VTD's junior studio, the team developed four prototypes, each subject to intense review by the team members. Examples of the prototypes are shown in the following figure. Each of the visual representations shown in the figure below reflects a maturing of the students' understanding of the processes and how different visual representations can tell a different story of traffic control systems. For example, the first prototype developed by the students showed only the traffic control processes themselves. Representations of traffic flow were added in the second prototype. Flexibility in moving and rearranging the various elements of the visualizations were added in the third and fourth prototypes. For each of the representations, the team members used output data from the VISSIM simulation model to create the traffic flow and control processes.

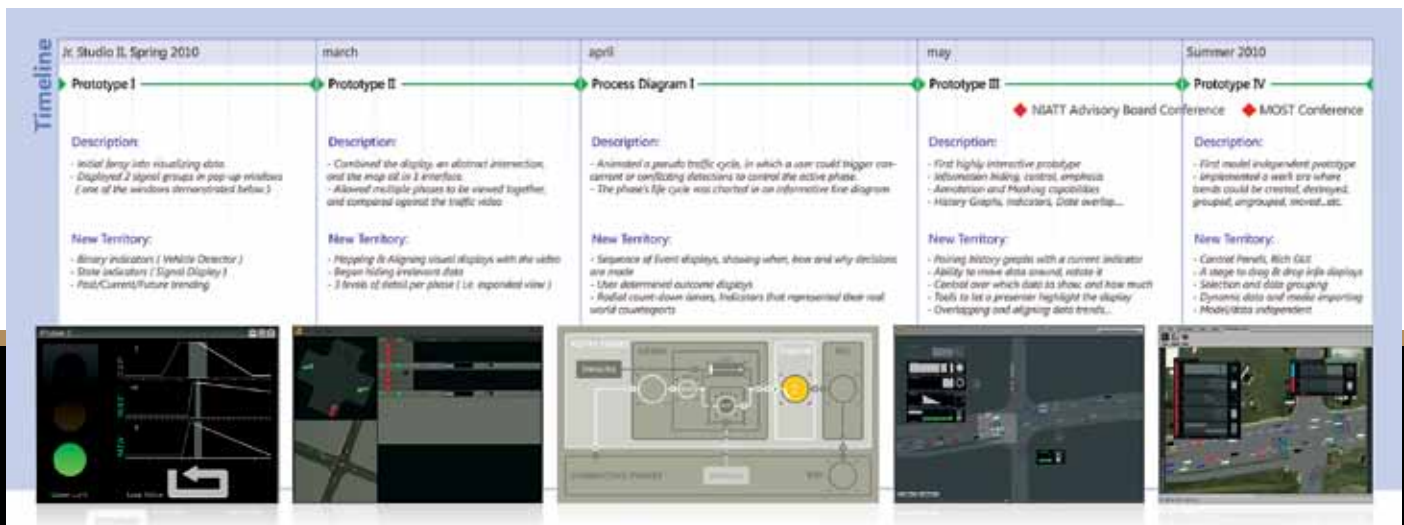

Prototypes from spring-summer 2010.

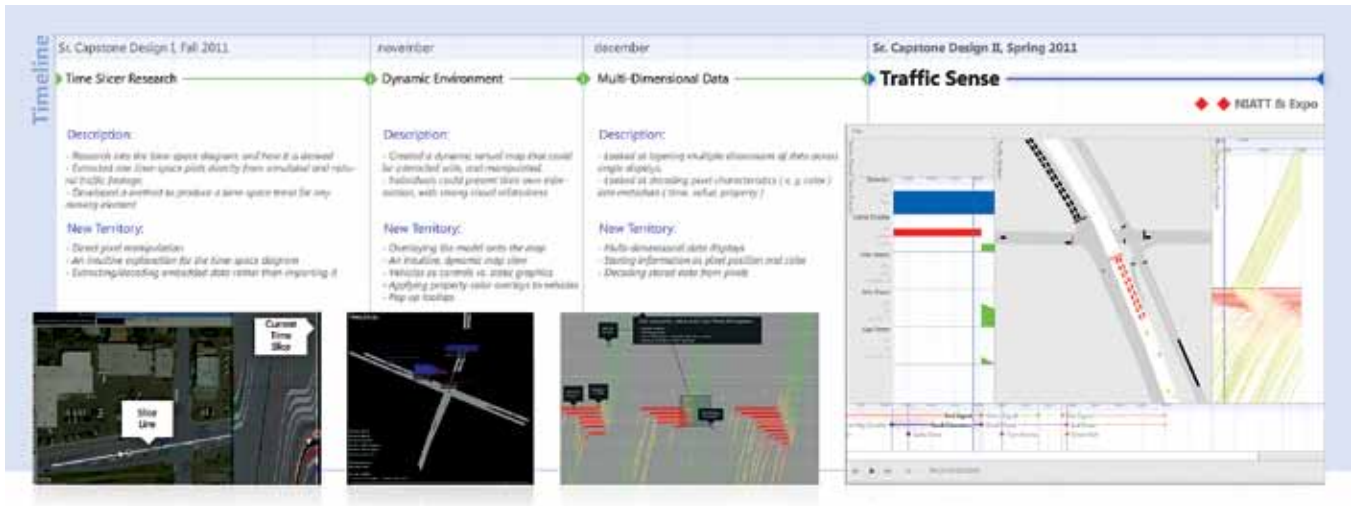

Prototypes from the 2010–2011 academic year.

During the second year of the project, coinciding with VTD's senior design studio, the student teams (consisting of **Bryan Foutch**, **Devin Abolins**, and **Jake Lauer**) experimented with several new displays, including adding time slicer functions, a more dynamic visual environment, and showing multi-dimensional data that could be added to the VISSIM output data. Examples of these displays are shown in the figure (top).

The final product, TrafficSense, was completed in time for presentation at the NIATT advisory board meeting and the University of Idaho Engineering Expo, held in April 2011. The TrafficSense tool combines six displays that operate together. The main window (center on the right figure) shows a representation of traffic flow during a railroad preemption sequence. The detection, timing, and displays are shown in the left portion of the figure. A time space diagram for the north-bound vehicles is shown at the right. On the lower portion of the figure, various elements of the control process elements are shown in sequence.

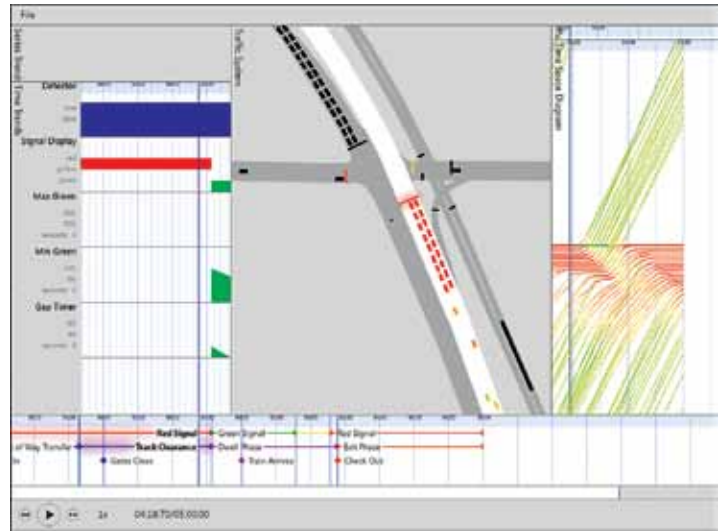

TrafficSense.



Dave Sherman preparing curriculum materials for the course modules in the NIATT Traffic Lab.

Project: Smart Signals Countdown Pedestrian Signals (KLK720)

Student Participation: **Cody Browne** (graduate student, electrical engineering); **Benjamin Jochen** (undergraduate student, electrical engineering); **Jacob Preston, Benjamin Sprague** (undergraduate students, computer engineering)

Principal Investigator: Dr. Richard Wall

Co-Principal Investigator: Dr. Brian Johnson

University Transportation Center Funding: \$124,631

Intersection Information System

In February 2011, an Advanced Accessible Pedestrian System (AAPS) was installed at the intersection of 6th and Deakin Streets in Moscow, Idaho. This intersection has been targeted to demonstrate the capabilities of network-based distributed controls for traffic systems since the project inception in 2004. Having a system that is installed a mere three blocks from the research lab allows us to readily observe operation and pedestrian behavior with the audible and visual interactive buttons.

The development team visited the Campbell Company manufacturing facility in Boise, Idaho. After a plant tour, the Smart Signals development team met with Campbell Company engineers and Terry McAdams with the Idaho Transportation Department to strategize on integrating next-generation enhancements into the AAPS. Following the meeting, students were given the opportunity to participate in the testing of AAPS equipment scheduled for delivery and installation.

This year's research focused on an Intersection Information System (IIS) designed to improve pedestrian safety at signalized intersections by providing drivers and pedestrians with visual information regarding activity in and around crosswalks. The system will provide more visual information for pedestrians with normal visual acuity but may have an auditory impairment due to ambient noise or physical disability. The additional information for pedestrians may be in the form of messages regarding approaching hazards due to abnormal traffic such as emergency vehicles or



Zane Sapp (Campbell Company engineer and UI MSEE 2010 graduate) and Cody Browne display the AAPS control that was installed at 6th and Deakin Streets.

trains. The system also displays variable message signs on the traffic signal cross arms regarding crosswalk activity, such as a message indicating that a blind or mobility-handicapped pedestrian is crossing the street and the driver should use extra caution when implementing turns that would put the pedestrian in their path. The variable messaging can also be used at night at poorly lit intersections for all pedestrian-activated crossings.

The figure below shows a block diagram of the equipment needed to implement the IIS at intersections with NEMA TS2 type traffic controllers. Items within the green shaded area constitute the IIS equipment. Items within the blue shaded area identify equipment that is located within the traffic controller cabinet. The area shaded in mauve identifies equipment that has been already developed as part of the AAPS work. An Ethernet link between the AAPS and the IIS permits the data exchange that conveys the information regarding the type of pedestrian call being served and the crosswalks that are involved.

Student Involvement

Cody Browne (graduate student, electrical engineering) is responsible for the design of the IIS and the pedestrian fault monitor. **Ben Sprague** (undergraduate student, computer engineering) is responsible for the enhanced Advanced Pedestrian Controller for the AAPS II. **Ben Jochen** (undergraduate student, electrical engineering) is responsible for passive pedestrian detection and next generation AAPS web-based instrumentation and control. **Jacob Preston** (undergraduate student, computer engineering) is responsible for Field-programmable Gate Array implantation of a Synchronous Data Link Control interface to traffic signal status.

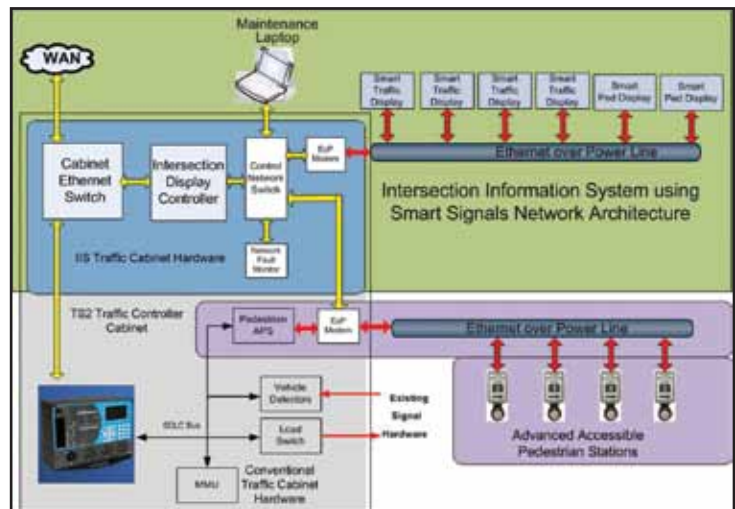

IIS architecture block diagram for NEMA TS2 traffic controllers and AAPS management system.



(Left-to-right) Ben Jochen, Ben Sprague, and Jacob Preston learn about the traffic signals that Campbell Company of Boise, Idaho makes at a tour of the facility in May 2011.



Zane Sapp shows Cody Browne the various types of pedestrian signals he is working on during the May 2011 visit.

Project: An Investigation of Transportation Professionals' Understanding of Geometric Design (KLK722)

Student Involvement: Shannon Davis (graduate student, civil engineering)

Principal Investigator: Dr. Michael Dixon

Co-Principal Investigator: Dr. Shane Brown at WSU

University Transportation Center Funding: \$96,029

Introduction

Previous research at NIATT expanded educator understanding of undergraduate student knowledge in highway design. This project is a critical next step in transportation engineering education, an area historically overlooked by the transportation engineering community. Put simply, how can educators continue to develop curricular materials and pedagogical methods until they have some knowledge of what students AND practitioners know?

The project will accomplish the following objectives:

1. Increase formal knowledge of practitioner understanding and misconceptions in highway geometric design.
2. Solidify support for focus areas emphasized in the May 2012 Type I NSF TUES proposal.
3. Build more national interest in understanding common misconceptions in transportation engineering.

Approach

As an expansion to the previous transportation engineering education project, this project involved interviewing practitioners and educators. The interviews are now complete, and researchers are analyzing the interview data. Researchers are also cataloging relevant geometric design materials included in educator lesson notes and common textbooks. This catalogued information will help researchers summarize the information to which students have access and how this relates to professional knowledge that tends to result later.



Shannon Davis (graduate student, civil engineering).

Project: Expanding City of Moscow Field Lab Data Collection Capabilities (KLK723)

Principal Investigator: Dr. Ahmed Abdel-Rahim

Co-Principal Investigator: Dr. Michael Dixon

University Transportation Center Funding: \$75,948

NIATT researchers, partnering with the Federal Highway Administration (FHWA), Idaho Transportation Department (ITD), and the City of Moscow, completed the City of Moscow signal integration project. The project was to upgrade the city's traffic signal system by connecting the city's 17 signalized intersections with a high-speed fiber-optic network, upgrading the cabinets in the intersections from TS1 cabinets to TS2-Type 1 cabinets, and upgrading the controllers in all intersections to NEMA TS2 controllers. In addition, the control of the city traffic signals is now done through advanced centralized control software. As part of the project, NIATT traffic controller labs were connected to the city's traffic signal system through a direct fiber-optic link. As an expansion to the project, 6 of the city's 17 intersections are equipped with CCTV cameras connected to the state communications system.

This project will expand the City of Moscow's field lab data collection capability by instrumenting the city's 17 intersections with devices capable of collecting real-time high resolution (100 milliseconds) detector and signal status data. NIATT researchers will design, test, and implement a high resolution signalized intersection monitoring system that is capable of collecting, storing, and disseminating traffic and signal operation data for the city's traffic signal system. The collected data will be used to develop field modules for illustrating traffic signal concepts for university students and practitioners. With such expanded field lab capabilities, the project constitutes a significant addition to NIATT and the nation's transportation research infrastructure and database in the area of traffic operations and control for medium- and small-sized cities.

Joint Center for Traffic Operations and Control and Center for Clean Vehicle Technology

Project: Modeling Vehicle Fuel Consumption and Emissions at Signalized Intersection Approaches: Assessing Available Tools and Research Needs (KLK721)

Student Involvement: Sherief ElBassuoni, Matt Ricks, Lionel Starchman (graduate students, civil engineering); Amanda Bolland (undergraduate student, mechanical engineering)

Principal Investigators: Dr. Ahmed Abdel-Rahim (CTOC) and Dr. Karen Den Braven (CCVT)

University Transportation Center Funding: \$70,557

In 2010, the Environmental Protection Agency (EPA) approved the Motor Vehicle Emissions Simulator model (MOVES2010) for official use. All state departments of transportation and metropolitan planning organizations (MPOs) will be required to use this model, after a two-year grace period, for new regional emissions analyses for transportation conformity determinations. It is critical to ensure that the data used in this model and in other microscopic modeling tools accurately reflect the emissions for criteria pollutants and greenhouse gases associated with transportation programs and projects, including the emissions and fuel consumption benefits associated with different traffic improvement projects. Research is therefore needed to identify, evaluate, and develop emission and fuel consumption data sets for real-time vehicle operating characteristics. The purpose of this research is to help provide transportation researchers and practitioners with a better understanding of macroscopic- and microscopic-level modeling of emission and fuel consumption. The output of the project improves the capability of more accurately analyzing the air quality and fuel consumption impact of different traffic improvement projects.

After a complete literature search to determine the current state-of-the-art, a first-order model of the effect of traffic control on fuel use will be created. The rates of fuel use will be evaluated during each "mode" of travel throughout the intersection approach: acceleration, deceleration, cruise, and idle. The relationship between vehicle fuel consumption and commonly used traffic measures, such as control delay at signalized intersections, will be investigated. Based on the results of the preliminary model, later plans call for the collection of real-time fuel use and vehicle emissions data through the use of a portable, On-board Emission Measurement unit (OEM 2100™). The OEM 2100 allows real-time, field data collection of second-by-second measurement of tailpipe emissions (i.e., CO, HC, and NO) and engine operations (i.e., speed and engine rpm). Data from this research can be used to verify, calibrate, and validate values obtained from the newly released EPA MOVES2010 model as well as other modeling tools

available. The output of the analysis will help identify data and research needed to improve the accuracy of vehicle fuel consumption and emissions predictions. The output of the project will provide practitioners throughout the nation with guidelines on how to use the MOVES model as well as other microscopic traffic modeling tools to assess the potential reduction in fuel use and emissions that could result from traffic signal improvement projects.

Amanda Bolland has expertise in engine performance and controls. She helped develop a real-time method of measuring vehicle performance, fuel use, and emissions on-road for use in traffic simulation models. She plans to pursue graduate work in this area, examining the effects of connecting vehicle fuel economy and emissions with traffic signal operation.

Lionel Starchman documented existing literature and the state-of-the-practice in the area of fuel consumption and emission modeling covering fuel consumption and emission estimate procedures in microscopic and macroscopic traffic simulation models; data input/output and emission and fuel consumption tables in the EPA MOVES model; relationship between vehicle trajectory at signalized intersection approaches and fuel consumption and emissions; and rates of fuel use and emission during each “mode” of travel throughout the intersection approach — acceleration, deceleration, cruise, and idle. He also assessed the validity of the fuel consumption and emissions data included in the microscopic simulation and MOVES models as they relate to signalized intersection operations.

Sherief ElBassuoni modeled a case study of an urban corridor using both the VISSIM microscopic simulation model and the MOVES model and documented the input data needed for the model, the calibration and validation process, and the fuel consumption and emission output. His work also included relating fuel use and emissions to each “mode” of travel throughout the intersection approach.



Amanda Bolland

Education

Objectives 3 and 4 of NIATT's Strategic Plan relate to education:

Objective 3. Increase the number of faculty and students in our research and education programs to enhance the transportation workforce.

Objective 4. Transfer the results of our research program to practicing professionals in forms that are usable to them to improve the quality and performance of our workforce.

NIATT Hosts TRB Traffic Signal Systems Committee Meeting

The 2010 Transportation Research Board's Traffic Signal Systems Committee meeting was held at the University of Idaho campus July 18–20, 2010. Michael Kyte worked diligently to prepare for the meeting, which was attended by 52 students and professionals in the traffic industry.

One full day of the meeting was devoted to current best practices and innovations in traffic signal education and training, including exploring the following questions:

- What do university students, engineers, and technicians in practice need to know and understand about traffic signal systems?
- What resources are available or needed to improve the skills and competencies of engineers and technicians in practice, of university faculty, and of university students?
- How can the Traffic Signal Systems Committee encourage the development of new educational materials, curriculum, tools, supporting research, and other activities to improve education and training in traffic signal systems?

NIATT researchers Ahmed Abdel-Rahim, Mike Dixon, Steve Beyerlein, Michael Kyte, and **Howard Cooley** (PhD candidate and 2009 NIATT Student-of-the-Year) used the meeting to showcase several education projects related to traffic signal systems, including the MOST (Mobile Signal Timing Training) project and the TransEd (Transportation Education Development Pilot Program) project. The team solicited feedback from the signal systems professionals attending the summer meeting, an important part of the work program for both projects. An expanded version of this day-long workshop was held at the annual meeting of the Transportation Research Board in January 2011.

Distance Education in the Pacific Northwest: Bridging Four Universities, 2,600 miles, and Academic Quarters and Semesters with Four New Transportation Courses!

Consider the challenge: four Pacific Northwest universities, each with small- to medium-sized transportation programs. Two of the universities operate on the semester system and two operate on the quarter system. The universities are a combined 2,600 miles apart. Each has a university transportation center. And there is a desire amongst the four universities to share their education programs, to give their students the chance to take a broader range of courses than are available at their home universities.

This is a challenge that the members of the Region X Transportation Consortium have been trying to solve for over 20 years! Since 2008, through a grant from the Federal Highway Administration's Transportation Education Development Pilot Program, a solution has begun to emerge.

This project, known formally as the "Development, Deployment, and Assessment of a New Educational Paradigm for Transportation Professionals and University Students," or TransEd for short, is a four year, \$1.2 million effort that includes the University of Idaho, Portland State University, the University of Alaska, the University of Washington, and Washington State University. The program is based on a new paradigm for educational content delivery—an active, problem-based learning environment conducted at a distance. Supported by educational research and the expertise of the faculty from the proposing institutions, this program seeks to enhance the quality of the learning environment for transportation students, thereby advancing the cause of transportation workforce recruitment, and to provide pedagogically sound, cost-effective training to practicing professionals in order to hone essential skills and promote workforce retention.



Howard Cooley conducting assessments of the course progress in the NIATT computer lab.

This year, the first pilot course was delivered to 15 students from the University of Idaho, Washington State University, the University of Washington, and Portland State University from January through March. This represented the first part of the spring semester at the University of Idaho and the entire spring quarter at the University of Washington and Portland State University. The course materials were developed by a University of Idaho team led by Michael Kyte and Steven Beyerlein and consisted of over 50 activities completed by the students as they prepared a signal timing design for an actual arterial street system. **Howard Cooley** (PhD graduate student, civil engineering) conducted regular assessments as the course progressed. Cooley said "students have responded positively to the unique learning environment that includes distance learning, teamwork skills, and heavy emphasis on observation of signalized intersection operations and processes. Difficulties of course design, new technologies, and communication concerns have been addressed through several pilot course iterations." Beyerlein noted that the first half of the curriculum development process identified key course outcomes and inventoried key knowledge elements. The second half of the process created engaging classroom sessions that involved thoughtful consideration of critical thinking questions by student teams, active experimentation with traffic simulation software, and real-time coaching by instructors. The magic behind the process was the alignment it insured between overall course design and learning activity design. Both the process and the product were improved through purposeful iteration in lively working sessions attended by multiple team members.

Presentations from each of the project team members were made at a special workshop conducted during the 2011 annual meeting of the Transportation Research Board in Washington, D.C. by Kelly Pitera (University of Washington), Ashley Haire (Portland State University), Ming Lee (University of Alaska), Clark Martin (Federal Highway Administration), and Michael Kyte (University of Idaho).

The project will be completed by summer 2012, at which time the materials developed for each of the four courses (Traffic Signal Timing Design, Transportation Data and Analysis, Freight Operations and Planning, and Highway Safety and Design) will be made available for use by other universities.

Awards



Kyte Receives the 2011 Teaching Excellence Award

Michael Kyte received the 2011 Teaching Excellence Award from the University of Idaho at the annual Excellence Awards in April. Dr. Kyte has had a long history of outstanding contributions to university transportation education and research. He served as the director of NIATT for 15 years.



Richard Wall (left) with UI President Duane Nellis at the awards ceremony.

Wall Receives the 2011 Innovations Impacting Society Award

Richard Wall received the University of Idaho's Innovations Impacting Society Award at the Entrepreneurship & Innovation Celebration in April. Dr. Wall was recognized for his patent of the Advanced Accessible Pedestrian System for signalized traffic intersections.



Ahmed Abdel-Rahim (right) with Dean Don Blacketter at the award ceremony.

Abdel-Rahim Receives the College of Engineering's Outstanding Faculty Award

Ahmed Abdel-Rahim received the College of Engineering's Outstanding Faculty Award at the awards ceremony in May 2011. Dr. Abdel-Rahim was selected for this award because of his excellent record in teaching, research, and service.



Randy Maglinao pictured in the center with his major professor, Brian He, on the left, and College of Engineering Dean, Don Blacketter, on the right.

NIATT PhD Graduate Receives the College of Engineering's Outstanding Graduate Student Award

Randy Maglinao (2011 PhD graduate in biological and agricultural engineering and NIATT research assistant) received the College of Engineering's Outstanding Graduate Student Award at the awards ceremony in May 2011. Randy's dissertation, entitled "Thermochemical Conversion of Glycerol to Primary and Polyhydric Alcohols," was in April. Randy worked as a research assistant for NIATT from August 2007 until he graduated in May 2011. He accepted a position as a research associate at Montana State University at Havre.

Our Students



CUTC honored the UTC students-of-the-year at the TRB Annual Meeting in Washington, DC. Pictured left to right: John Porcari (USDOT), NIATT's student-of-the-year, Dylan Dixon, Steve Albert (CUTC president), and Peter Appel (RITA administrator). Photo courtesy of ARTBA.

NIATT Student-of-the-Year: Dylan Dixon

NIATT joins in congratulating the students-of-the-year representing each of their respective UTCs. NIATT's 2010 Student-of-the-Year is first-year graduate student **Dylan Dixon**. Dylan received his award at the 2011 Council of University Transportation Centers (CUTC) Awards Banquet in January 2011.

It's unusual for a student to receive this honor for their first year of graduate school, but Dylan has been working with NIATT for over five years. He began with the UI Clean Snowmobile Challenge Team as a freshman, and he has become a valuable team member. He was team captain for two years, and he is now a graduate mentor. Under his leadership, the team achieved a second and a third place in the Society of Automotive Engineers (SAE) national competition. He also has had a professional internship with Bombardier/Evinrude, assisting in engine development efforts, bringing that experience back to the team.

Recently Dylan was selected to attend the SAE Small Engine Technology Conference in Linz, Austria to present a design paper on the clean snowmobile team's entry in the 2009 Challenge.

Dylan's graduate work is focused on exploring the benefits of exhaust throttling in a two-stroke engine. This work will look at the effects of exhaust throttling on emissions, efficiency, and power output, as well as automating and installing the system on a snowmobile. In his free time, he enjoys modifying and riding motorcycles and other motorized equipment.



The Clean Snowmobile Challenge Team received a Technical Session Award at the 2011 Engineering EXPO. Representing the team (left-to-right) are **Eric Buddrius**, **Alex Fuhrman**, **Jeremy Nichols**, **Andrew Hooper**, and College of Engineering Dean, **Don Blackketter**.



The Formula Hybrid Team received a Booth & Exhibit Award at the 2011 Engineering Expo. Representing the team are **Nathan Repp** (left) and **Zack Porter** with Dean **Blackketter**.

College of Engineering EXPO Moments — Senior Design Presentations

The University of Idaho has a year-long, senior design program between the departments of mechanical and electrical engineering. Each year, this involves over 20 industry- and research-sponsored projects to produce manufacturing fixtures and test equipment, design consumer products, and invent one-of-a-kind machines. Capstone design coordinator, Dr. Steve Beyerlein, has developed a network of companies and contacts that annually contribute more than \$100,000 toward the capstone program at the University of Idaho. The scope of student projects can be seen in the archive at <http://seniordesign.engr.uidaho.edu>. Design products are also shown to the public in the UI Engineering Design Expo each spring. This is the largest academic design show in the Pacific Northwest. Senior design teams are guided by a half-dozen graduate mentors doing research in related areas. Dr. Beyerlein works closely with Dr. Edwin Odom and Russ Porter in mentor training and coaching. The capstone design program has been an excellent tool for recruiting and training graduate students in transportation technology who are well versed in solid modeling, manufacturing processes, and experimental methods.

Society of Automotive Engineers (SAE) A World In Motion® (AWIM)— Helping Today's Students Become Tomorrow's Engineers

October and November 2010, the University of Idaho's Formula Hybrid Racing team participated in the Society of Automotive Engineers (SAE) A World In Motion® (AWIM) program, a teacher-administered, industry volunteer-assisted program that brings science, technology, engineering, and math (STEM) education to life in the classroom for students in kindergarten through grade 12. The AWIM program incorporates the laws of physics, motion, flight, and electronics into age-appropriate hands-on activities that reinforce classroom STEM curriculum. This year the Vandal Hybrid Racing team, represented by **Samuel Wos, Chad Barnes, Cory Bellanger, Lewis Hamberlin, Samantha Hendrickson, and Justin Shook**, had the opportunity to lead an AWIM program, mentoring students at the Palouse Prairie Charter School.

The students, ranging from the ages of 4 to 7, were presented with a letter from a fictitious toy company and challenged to build new models of jet cars (cardboard frame with a balloon for propulsion) for the company's catalog. The requirements for the toys were that they had to be robust enough for daily use and vary in functionality and design. The students were then divided into teams of three, alternating responsibilities and roles. The project engineer led team discussions, oversaw the safety of the group, and made sure everyone was on task. The facilities engineer was in charge of materials, clean up, and model construction. The test engineer designed the tests, recorded results, and collaborated on needed modifications.

Every Wednesday afternoon, three or four members of the Vandal Hybrid Racing team spent several hours working with the students on designing, building, and testing their jet cars. Multiple experiments were done to gain an understanding of the operation of the chassis, effects of the balloon motor and nozzle sizes on performance, and the principles of momentum, force, and friction. The knowledge gained was then used to build a variety of designs targeting specific ages and genders.

When discussing performance goals, each team displayed a clear understanding of what hardware needed to be implemented in the design to achieve the desired results. The students displayed tremendous amounts of creativity in all facets of the design processes. Their imaginations and insights from past experiences allowed them to develop quality products that would be enjoyed by many kids and adults.

Not only did the students learn about math, science, and technology, but they also learned about careers in engineering that they may not have been aware of. The AWIM program provides a great opportunity for the Vandal Racing team to give back to the local community. With this year being such a success, the team has made a commitment to help with the program every year. For more information on the AWIM program, please visit AWIM.org or SAE.org. More information about the Vandal Hybrid Racing team is available at <http://seniordesign.engr.uidaho.edu/2010-2011/hybridformula/>.

Congratulations to the 2011 Clean Snowmobile Team

The 2011 NIATT Clean Snowmobile team captured the overall third place as well as the following:

First Place Awards

- Best Design Paper
- Michigan Snowmobile Association Endurance Award (100 mile endurance run)
- NGK Spark Plugs Cold Start Award
- Land and Sea Award for Best Performance
- EMITEC Award for Best Value

Bill Paddleford Founder’s Award for Most Sportsmanlike Conduct (a team member put out a fire on a competitor’s sled during the endurance run, and the team loaned another competitor an EMM and programmed it for them)

The only sled to place in fuel economy, emissions, and sound

Second Place Awards

- Most Practical
- Best Ride
- Best Design
- Subjective Handling
- In-Service Emissions



Alex Fuhrman during the endurance run. Photo courtesy of MTU/KRC.

2011 Clean Snowmobile Team Members

Dylan Dixon (Bow, Washington)
Graduate mentor, mechanical engineering

Austin Welch (Peoria, Arizona)
Co-captain and graduate mentor, mechanical engineering

Parley Wilson (Alta, Wyoming)
Graduate mentor, mechanical engineering

Amos Bartlow (Nampa, Idaho)
Sophomore, electrical engineering

Ben Birch (Anchorage, Alaska)
Senior, sports science

Cole Bode (Moore, Idaho)
Senior, electrical engineering

Amanda Bolland (Ashton, Idaho)
Senior, mechanical engineering

Eric Buddrius (Blanchard, Idaho)
Senior, mechanical engineering

David Erickson (Issaquah, Washington)
Freshman, mechanical engineering

Alex Fuhrman (Green Acres, Washington)
Senior, mechanical engineering

Christopher Hill (Craigmont, Idaho)
Senior, mechanical engineering

Andrew Hooper (Rathdrum, Idaho)
Co-Captain; senior, mechanical engineering

Ian Lootens (Marsing, Idaho)
Senior, mechanical engineering

Dallyn Lord (Arco, Idaho)
Freshman, rangeland ecology & management

Ty Lord (Arco, Idaho)
Senior, mechanical engineering

Neil Miller (Saint John, Washington)
Junior, mechanical engineering

Jeremy Nichols (Waitsburg, Washington)
Junior, mechanical engineering

Sam Smith (White Bird, Idaho)
Junior, PTTE-technology education option



The 2011 team members who attended the competition are (back row) **Dylan Dixon**, **Ian Lootens**, **Sam Smith**, **Austin Welch**, **Dallyn Lord**, **Jeremy Nichols**, **Chris Hill**, (front row) **Cole Bode**, **Alex Fuhrman**, **Ty Lord**, and **Amos Bartlow**. Photo courtesy of MTU/KRC.

Future Students

JEMS Summer Program written by Mary Lee Ryba

The July 2010 Idaho Junior Engineering, Math, and Science (JEMS) summer program was another great success thanks to JEMS Director and Chair of the Department of Civil Engineering, Richard Nielsen, faculty and staff members, and a grant from the Federal Highway Administration. This year was one of the highest enrollments that we have seen in several years with 50 students coming from as far as Puerto Rico, Hawaii, and Louisiana. Teams of students developed designs for the "Personal Urban Vehicle" (PUV) powered by ultra capacitors donated by Ivus Energy Innovations. The goal was to allow individuals to go where they want, when they want, using a variety of alternate energy sources. Students learned about using novel but existing technologies in their quest to design the best PUV.

The students attended three classes every day, learning how to design and race their own small-scale vehicles. The students began with an Engineering Electricity and Motors class taught by Dr. Bob Rinker. In this class, the students received an overview of information that they would need to successfully build their vehicles, including in-depth instruction on circuits. They also attended a SolidWorks computer modeling class taught by Ph.D. student **Jennifer Hasenoehrl** and an Engineering Mechanics course taught by Dr. Don Elger.

The JEMS students were invited to tour Schweitzer Engineering Laboratories in Pullman, to join a creek restoration project with Palouse Clearwater Environmental Institute (PCEI), and to take a tour of the Lower Granite Dam. The students also mingled with professors here at the College and experienced firsthand just how much our university has to offer.

After two weeks of hard work, the students participated in a vehicle competition that was judged on several criteria, including speed, efficiency, hill climb, style, and overall best vehicle. To conclude the week, the students gave a technical presentation to a panel of judges from the University of Idaho and Ivus Energy Innovations followed by an award ceremony.



2010 JEMS Students and Instructors

Technology Transfer

Patents Pending

Synchronous Charge Trapping

One of the snowmobile senior design teams developed what is known as a synchronous charge trapping (SCT) valve for which a patent is pending. In this design (see figure below), the valve is rotated 360 degrees parallel to the crankshaft. The two rotating valves are located 180 degrees apart from each other on a common valve shaft. A counterbalance for each valve ensures the valve is balanced on the shaft. Instead of using high-temperature bushings inside the aluminum insert, the design uses two high-temperature bearings on the outside of each engine cylinder. The valves are rotated using a belt and pulley system that is driven by the rotation of the engine's crankshaft. The 360-degree rotation of the valves eliminates the stresses in the shaft. In preliminary laboratory tests, the engine has operated at speeds up to 6000 rpm.

Smart Signals Technology

The Advanced Accessible Pedestrian Control System for the Physically Disabled and the Advanced Accessible Pedestrian System (AAPS) for Signalized Traffic Intersections are two patents pending for the Smart Signals Technology team led by Dr. Richard Wall. Dr. Wall will receive funding from the Idaho State Board of Education to develop and test an environmentally hardened pedestrian fault monitor to work with the AAPS.

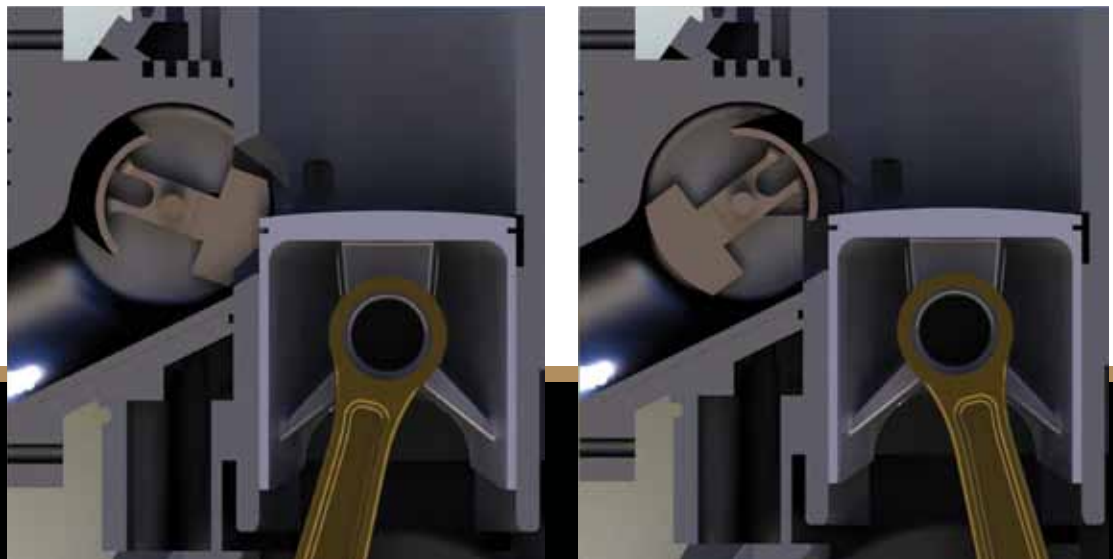

Cutaway view of the rotary SCT valve in a two-stroke engine.

Activities in the Region X Consortium

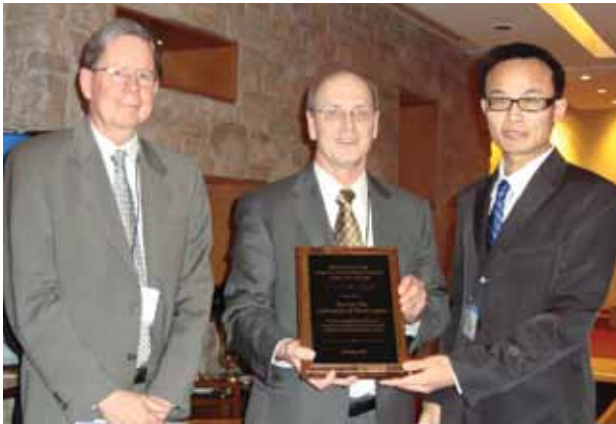

Yao-Jan Wu receives the 2010 Michael Kyte Region X Student-of-the-Year Award from Michael Kyte (left) and Billy Connor (University of Alaska, Fairbanks).

The next Region X Consortium meeting will be held after the University of Idaho's fiscal year end on Sunday, July 24, 2011 in Salt Lake City, Utah in conjunction with the AASHTO's Research Advisory Committee meeting.

Items of discussion at the Region X meeting include the future of Region X Consortium and the status of the UTC request for proposals.

The 8th Annual Region X Student Conference was held at Oregon State University in Corvallis, Oregon on February 18, 2011. The annual conference provides a forum for graduate students to share their research with each other in lecture-style presentations and poster presentations, as well as make professional connections with each other and representatives from sponsors. The keynote speaker at the conference was Galen McGill, manager of the Intelligent Transportation Systems unit for the Oregon Department of Transportation. The students were able to attend three workshops during the event: 1) high speed rail, 2) accessible transportation, and 3) traffic simulation workshop.

UTC's Region X Transportation Consortium joined together to host a reception at the 90th Annual Meeting of the Transportation Research Board in Washington, DC, January 25, 2011. Representatives from the universities were there to talk to guests about the research being done at the UTCs.

The 2010 Michael Kyte Region X Student-of-the-Year award was presented at the reception to **Yao-Jan Wu** from TransNow at the University of Washington. The decision was so close that a runner-up award was also presented to **Alex Bigazzi** from OTREC at Portland State University. Congratulations Yao-Jan and Alex!

Region X Transportation Consortium Annual Reception Invitation



Tuesday, January 25, 2011

6:00 pm – 7:30 pm

Marriott Wardman Park Hotel

Stone's Throw Restaurant/Private Dining Room

Join us for appetizers, interact with our partners, meet our outstanding students of the year, and learn more about our active region. Meet with colleagues from Alaska, Washington, Oregon, Idaho and welcome Montana to the consortium.



Sponsored by the University Transportation Centers of Alaska, Washington, Oregon, Idaho and Montana

Financial Report

UTC Expenditures — FY11

In fiscal year 2011, NIATT research project expenditures once again focused on student support. Sixty-seven percent of University Transportation Center funds expended (excluding indirect costs and fringe benefits) were used for student salaries and scholarships/tuition. NIATT director and staff salaries were paid from matching funds, as were faculty research salaries during the academic year.

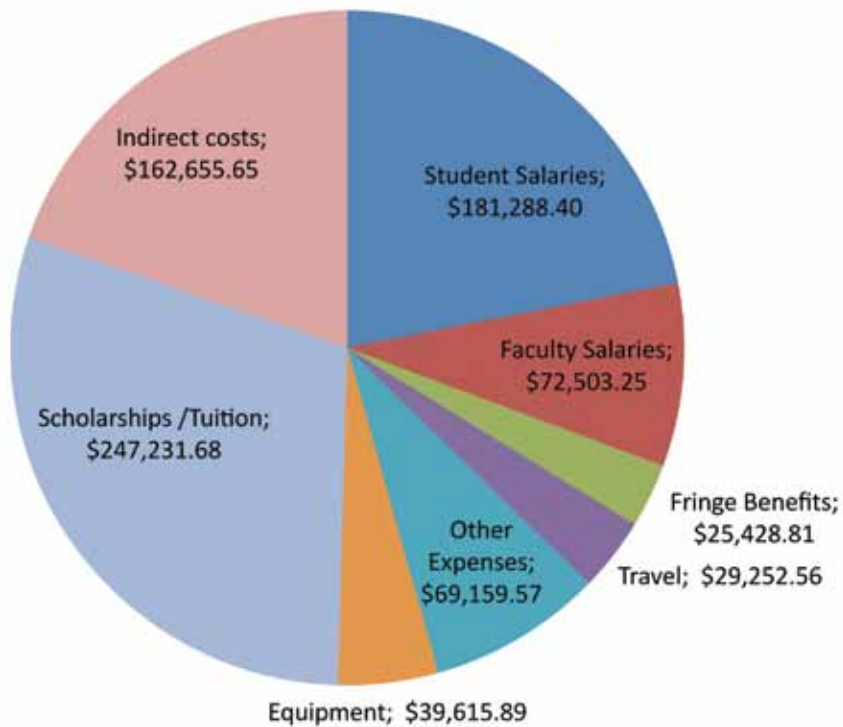

Sources of NIATT FY11 Expenditures

The chart below shows the source of NIATT expenditures from FY11. The "other grants" represent funding from Campbell Company, NSF, NCHRP, and other sources. The chart does not reflect University of Idaho support used for cost-sharing.

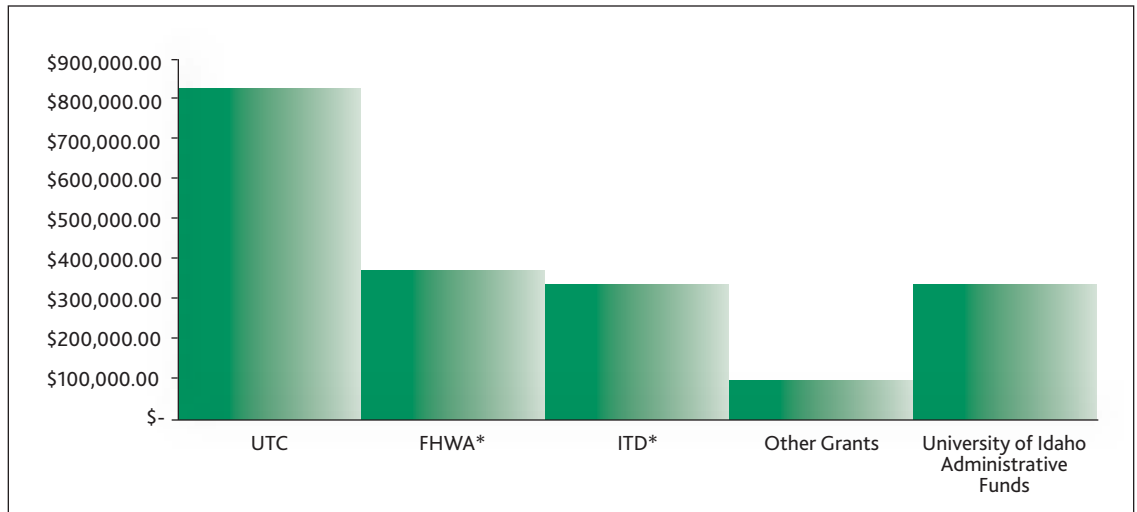

*Federal Highway Administration

**Idaho Transportation Department

UTC Project Status

Projects begun in FY11—Year 4 of DTRT07-G-0056

- | | |
|--|---|
| <p>KLK718 Using Visual Simulation Tools & Learning Outcomes-Based Curriculum to Help Transportation Engineering Students & Practitioners to Better Understand & Design Traffic Signal Control Systems
Center for Traffic Operations and Control
Dr. M. Kyte & J. Anderson</p> | <p>KLK762 Aqueous Ethanol Ignition and Engine Studies, Phase II
Center for Clean Vehicle Technology
Drs. J. Steciak, S. Beyerlein & R. Budwig</p> |
| <p>KLK720 Smart Signals Countdown Pedestrian Signal
Center for Traffic Operations and Control
Drs. R. Wall & B. Johnson</p> | <p>KLK763 Development of a Low-Speed, Two-Stroke, Direct-Injection Snowmobile for Use in the Clean Snowmobile Challenge and National Parks
Center for Clean Vehicle Technology
Dr. K. Den Braven</p> |
| <p>KLK721 Modeling Vehicle Fuel Consumption and Emissions at Signalized Intersection Approaches: Assessing Available Tools & Research Needs
Center for Traffic Operations and Control
Drs. A. Abdel-Rahim & K. Den Braven</p> | <p>KLK764 Design Synthesis, Manufacturing, & Testing of a Competitive Hybrid FSAE Vehicle
Center for Clean Vehicle Technology
Drs. E. Odom, S. Beyerlein & J. Law</p> |
| <p>KLK722 An Investigation of Transportation Professional's Understanding of Geometric Design
Center for Traffic Operations and Control
Drs. M. Dixon & S. Brown (WSU)</p> | <p>KLK765 Continuous-Flow Reactor System for Improved Catalytic Glycerol Conversion
Center for Clean Vehicle Technology
Dr. B. He</p> |
| <p>KLK723 Expanding City of Moscow Field Lab Data Collection Capabilities
Center for Traffic Operations and Control
Drs. A. Abdel-Rahim & M. Dixon</p> | <p>KLK766 Production of Renewable Diesel Fuel from Biologically Based Feedstocks
Center for Clean Vehicle Technology
Drs. J. Van Gerpen & B. He</p> |

Projects Continuing from FY10

- KLK717 An Architecture for Implementing Improved Queue Spillback Control Strategies**
Center for Traffic Operations and Control
Drs. M. Dixon, A. Abdel-Rahim & R. Wall

Projects Completed— Final Reports in Review

- KLK716 Improved Simulation of Driver Behavior: Modeling Protected and Permitted Left-Turn Operations at Signalized Intersections**
Center for Traffic Operations and Control
Drs. A. Abdel-Rahim, M. Kyte & M. Dixon

Projects Completed

- KLK710 Street Deployment of Pedestrian Control Smart Traffic Signals**
Center for Traffic Operations and Control
Drs. R. Wall, J. Frenzel & B. Johnson
- KLK711 Traffic and Controller Data Collection System Enhancement, Deployment, and Testing**
Center for Traffic Operations and Control
Drs. M. Dixon, A. Abdel-Rahim & R. Wall
- KLK712 Improved Simulation of Stop Bar Driver Behavior at Signalized Intersections**
Center for Traffic Operations and Control
Drs. M. Kyte, M. Dixon & A. Abdel-Rahim
- KLK713 Developing and Applying Collaborative Tools for Improving "Understanding" in the Introductory Transportation Engineering Course**
Center for Traffic Operations and Control
Drs. M. Kyte, M. Dixon & A. Abdel-Rahim
- KLK714 Geometric Design—Subcontract to WSU**
Center for Traffic Operations and Control
Dr. M. Dixon
- KLK715 Commercialization and Field Distribution of Smart Pedestrian Call Signals**
Center for Traffic Operations and Control
Drs. R. Wall & J. Frenzel
- KLK719 Closed Loop Operation of Network Based Accessible Pedestrian Signals**
Center for Traffic Operations and Control
Drs. R. Wall, M. Kyte & B. Johnson
- KLK750 Thermal Processing of Low-Grade Glycerol to Alcohols for Biodiesel Production**
Center for Clean Vehicle Technology
Dr. B. He
- KLK751 Development of an Ethanol-Fueled, Two-Stroke, Direct-Injection Snowmobile for Use in the Clean Snowmobile Challenge and National Parks**
Center for Clean Vehicle Technology
Dr. K. Den Braven
- KLK752 Compression Ratio and Catalyst Aging Effects on Aqueous Ethanol Ignition**
Center for Clean Vehicle Technology
Drs. J. Steciak, S. Beyerlein & R. Budwig
- KLK753 Development of a Flex-Fuel, Two-Stroke, Direct-Injection Snowmobile for Use in the Clean Snowmobile Challenge and National Parks**
Center for Clean Vehicle Technology
Dr. K. Den Braven
- KLK754 Thermal Processing of Low-Grade Glycerol to Alcohols for Biodiesel Production, Phase II**
Center for Clean Vehicle Technology
Dr. B. He
- KLK755 Measurement and Control Strategies for Sterol Glucosides to Improve Biodiesel Quality**
Center for Clean Vehicle Technology
Drs. J. Van Gerpen & B. He
- KLK756 Compression Ratio and Catalyst Aging Effects on Aqueous Ethanol Ignition, Phase II**
Center for Clean Vehicle Technology
Drs. J. Steciak, S. Beyerlein & R. Budwig
- KLK757 Hybrid FSAE Vehicle Realization**
Center for Clean Vehicle Technology
Drs. E. Odom, S. Beyerlein & J. Law
- KLK758 Application of Metal Catalysts for High Selectivity of Glycerol Conversion to Alcohols**
Center for Clean Vehicle Technology
Dr. B. He
- KLK759 Measurement and Control Strategies for Sterol Glucosides to Improve Biodiesel Quality – Year 2**
Center for Clean Vehicle Technology
Drs. J. Van Gerpen & B. He
- KLK760 Development of an Ethanol Blend, Two-Stroke, Direct-Injection Snowmobile for Use in the Clean Snowmobile Challenge and National Parks**
Center for Clean Vehicle Technology
Dr. K. Den Braven
- KLK761 Aqueous Ethanol Ignition and Engine Studies, Phase I**
Center for Clean Vehicle Technology
Drs. J. Steciak, S. Beyerlein & R. Budwig



**National Institute for Advanced
Transportation Technology**

University of Idaho
Engineering Physics Building 115
PO Box 440901
Moscow, ID 83844-0901

Telephone: (208) 885-0576

Fax: (208) 885-2877

<http://www.niatt.org>