

# University of Idaho

Architectural and  
Engineering Services

## DESIGN GUIDELINES and CONSTRUCTION STANDARDS

*Prepared by:*

**Architectural and Engineering Services  
University of Idaho**

875 Perimeter Drive MS2281  
Moscow, Idaho 83844-2281  
208-885-6246

*Director:*

Raymond Pankopf, NCARB

*Construction Manager:*

Matt Proctor

**Version 2022-11.08**

## **INTRODUCTION**

The University of Idaho is the state's land-grant research university. From this distinctive origin and identity comes our commitment to enhance the scientific, economic, social, legal and cultural assets of our state and to develop solutions for complex problems facing our society. We deliver focused excellence in teaching, research, outreach and engagement in a collaborative environment at our residential main campus in Moscow, regional centers, extension offices and research facilities across Idaho. Consistent with the land-grant ideal, our outreach activities serve the state as well as strengthen our teaching, scholarly and creative capacities statewide.

Our educational offerings seek to transform the lives of our students through engaged learning and self-reflection. Our teaching and learning includes undergraduate, graduate, professional and continuing education offered through face-to-face instruction, technology-enabled delivery and hands-on experience.

The physical facilities at the University of Idaho exist to aid in the achievement of this mission. Our facilities must not only be accommodating, inspirational and sustainable in their design, they must also be cost efficient to operate and maintain.

The goal of these Design Guidelines and Construction Standards is to document institutional experience, knowledge and standards associated with the design and construction of projects that contribute to a manageable and maintainable inventory of high-performance facilities throughout the State of Idaho on all properties owned by the Board of Regents, the University of Idaho.

These guidelines are intended to be used to:

- ... provide guidance for University of Idaho staff who are tasked with oversight and management of design and construction projects on University properties.

- ... assist architects, engineers and design professionals in understanding the policies, standards, procedures and preferences of the University related to the planning, design, maintenance, construction and repair of University facilities.

- ... assist contractors to understand the policies, standards, preferences and special conditions required to safely and efficiently engage in construction work on University properties.

The requirements of these guidelines and standards are not intended to supersede any adopted or applicable building code, ordinance, statute, regulation or law. If there is a conflict with any requirement in the design guidelines or the construction standards, the applicable code or law takes precedence.

The requirements of these guidelines and standards are not intended to limit design expression, creativity, or material selections for design professionals, nor are they intended to dictate means, methods, techniques and procedures for contractors. The University of Idaho highly values the industry expertise and dynamic problem-solving capabilities of our growing community of consultants and contractors. We endeavor to support these relationships and to foster an atmosphere where university staff, consultants and contractors can thrive personally, prosper professionally, and be proud of the work accomplished in support of the University's greater mission.

The Design Guidelines and Construction Standards document is intended to be a 'living' document, designed to keep abreast of new and better procedures, technologies, materials, products, and strategies available in the design and construction industry. This document will be reviewed, edited, and amended on an annual basis, or as needed, to keep up with evolving standards.

# CONTENTS

COVER

INTRODUCTION

CONTENTS

## SECTION I – DESIGN GUIDELINES

Chapter 1	Scope and Intent
Chapter 2	Statutes, Regulations and Policies
Chapter 3	Campus Planning Resources
Chapter 4	Standard Design Elements and Details
Chapter 5	Roles and Responsibilities
Chapter 6	Surveys, Testing and Commissioning
Chapter 7	Sustainable Design
Chapter 8	Planning & Design Phase
Chapter 9	Construction Documents
Chapter 10	Bidding, Printing, and Permits
Chapter 11	Construction Administration
Chapter 12	Project Closeout
Chapter 13	Public Works Contractor Requirements

## SECTION II – CONSTRUCTION AND TECHNICAL STANDARDS

00	Scope and Intent
Division 01	General Requirements
Division 02	Existing Conditions
Division 03	Concrete
Division 04	Masonry
Division 05	Metals
Division 06	Wood, Plastics, and Composites
Division 07	Thermal and Moisture Protection
Division 08	Openings
Division 09	Finishes
Division 10	Specialties
Division 11	Equipment
Division 12	Furnishings
Division 13	Special Construction
Division 14	Conveying Equipment
Division 21	Fire Suppression
Division 22	Plumbing
Division 23	Heating, Ventilating, and Air Conditioning (HVAC)
Division 26	Electrical
Division 27	Communications (e.g., data, voice, audio/visual systems)
Division 28	Electronic Safety and Security
Division 31	Earthwork
Division 32	Exterior Improvements
Division 33	Utilities

## APPENDIX A – SAMPLE FORMS AND DOCUMENTS

Supplemental Conditions to Owner / Architect Agreement AIA B101-2017  
Sample Letter Contract  
Sample Abbreviated Bid Form  
Sample Request for Insurance Certificate  
Sample Facilities Payment Application  
Sample Pre-Bid Conference Agenda  
Sample Pre-Construction Conference Agenda  
Sample Warranty Deficiency Report  
Sample Key Request Form



# SECTION I DESIGN GUIDELINES



## **CHAPTER 1 - SCOPE and INTENT**

These Section I - Design Guidelines and referenced appendices are for Design Professionals (architects, engineers & specialty consultants) and Contractors (public works contractors or other vendors) who are engaged in design or construction agreements with the University of Idaho. They are not intended to modify or eliminate any of the terms or provisions of the Owner/Consultant/Contractor Agreements. If conflicts occur between the Agreement and these guidelines, the Agreement shall govern. The University of Idaho Project Manager will determine which guidelines are applicable for individual projects.

The Design Guidelines are heavily weighted to give guidance and instructions to Design Professionals in the production of contract documents and specifications that will form the basis of requirements for construction documentation. Contractors are encouraged to read these guidelines to understand University requirements and to especially review "Chapter 13 – Public Works Contracting Requirements".

Both Design Professionals and Contractors are directed to review Section II – Construction and Technical Standards. Contractors should review on-campus work requirements outlined in "Division 1 – General Requirements".

The requirements of these guidelines and standards are not intended to supersede any adopted or applicable building codes, ordinances, statutes, regulations or laws. If there is a conflict with any requirement in the design guidelines or the construction standards, the applicable code or law takes precedence.

## **CHAPTER 2 - STATUTES, REGULATIONS, and POLICIES**

### **2.1 Contracting Authority**

#### **2.1.1 History**

The University of Idaho was founded January 30, 1889, by an act of the 15th and last territorial legislature. That act, commonly known as the university's charter, became a part of Idaho's organic law by virtue of its confirmation under article IX, section 10, of the state constitution when Idaho was admitted to the union. As the constitution of 1890 provides, "The location of the University of Idaho, as established by existing laws, is hereby confirmed. All the rights, immunities, franchises, and endowments heretofore granted thereto by the territory of Idaho are hereby perpetuated unto the said university. The regents shall have the general supervision of the university and the control and direction of all the funds of, and appropriations to, the university, under such regulations as may be prescribed by law."

Under these provisions, the University of Idaho was given status as a constitutional entity. Though the university is to be governed under regulations as may be prescribed by law, the regents were specifically given control of the funds and conditions of employment. Thus, the Board of Regents (designated in the territorial act as a body corporate and named "The Regents of the University of Idaho") has wide-ranging authority not inherent in the governing board of the other institutions in Idaho's state system of higher education.

#### **2.1.2 Idaho State Board of Education - Governing Policies and Procedures**

Section V. Financial Affairs, Subsection C, Paragraph 1.c - The University of Idaho and the Board of Regents of the University of Idaho, by virtue of their constitutional status and unique standing under federal or state law, may expend certain monies which are not General Fund monies without the overall supervision and control of any other branch, department, office, or board of Idaho state government.

### **2.2 Design & Construction Managed by the University of Idaho**

If the project funding for a design and construction project is entirely composed of federal grants, internal capital or private monies, and no funding from the State of Idaho Permanent Building Fund is involved, then the project will be managed at the University of Idaho level and the Regents, University of Idaho will be the Owner. The State of Idaho, Division of Public Works will have no involvement in the project. Under this situation, the

University of Idaho, Facilities, Department of Architectural and Engineering Services will manage the design and construction of the project.

(These Design and Construction Guidelines are most specifically aimed at this scenario.)

### **2.3 Design & Construction Managed by the State of Idaho Division of Public Works**

If the funding received for a design and construction project includes any funding from the State of Idaho Permanent Building Fund, usually through legislative appropriation, the project will be constructed under the auspices of the State of Idaho Division of Public Works (DPW). At that point, DPW will assign the project to one of their project managers. Although the University of Idaho will have considerable input, the University will be considered the Agency, and DPW will be considered the Owner. All contracts will be administered and signed by DPW, and the Owner's representative will be the DPW Project Manager. All project standards will follow DPW rules and regulations. <https://dpw.idaho.gov/>

Design Professionals and Contractors working on University of Idaho projects under the administration of the Division of Public Works shall still be expected to review the UI Design Guidelines and Construction Standards.

### **2.3 Regents Authorizations and Approvals**

Idaho State Board of Education - Governing Policies and Procedures;  
Section: V. Financial Affairs; Subsection: K. Construction Projects

#### **2.3.1 Authorization Limits**

Without regard to the source of funding, before any institution or agency under the governance of the State Board of Education begins to make capital improvements, either in the form of alteration and repair to existing facilities or construction of new facilities, it must be authorized based on the limits listed below. Projects requiring executive director or Board approval must include a separate budget line for architects, engineers, or construction managers and engineering services for the project cost.

- Agency Level Authorization: \$500,000 or less
- Executive Director Authorization: \$500,000 to \$1,000,000
- Full Board Authorization: Greater than \$1,000,000

#### **2.3.2 Major Projects - Capital Construction Plans**

Institutions and agencies under the governance of the Board wishing to undertake capital construction projects shall submit to the Board for its approval a six-year capital construction plan (the "Plan"). The Plan shall span six fiscal years going forward starting at the fiscal year next. The Plan shall include only capital construction projects for which the total cost is estimated to exceed one million dollars (\$1,000,000) without regard to the source of funding (hereinafter, "major projects"). A Plan shall constitute notice to the Board that an institution or agency may bring a request at a later date for Board approval of one or more of the projects included in its approved Plan. Board approval of a Plan shall not constitute approval of a project included in the Plan.

Before any institution or agency under the governance of the Board solicits, accepts or commits a gift or grant in support of a specific major project, such project must first be included on the institution's or agency's Board-approved six-year Plan.

#### **2.3.2 Major Projects Approval Process**

##### **2.3.2.1 Planning and Design Approval**

Planning and Design approval is required before any institution or agency begins planning and design on a major project carried out under the traditional "design-bid-build" method. For design-bid-build projects, planning and design encompasses the preparation of architectural and engineering documents and associated budget and schedule information through the completion of the construction documents for bidding. This approval may not be requested concurrently with any other step in the major project approval process. As part of the Board's approval process for planning and design, the Board may request the institution or agency to submit a preliminary project budget and financing plan (including pro forma financials, debt/operating expenses ratios, pledges, strategic facilities fees, and other material financial information).

### 2.3.1.2 Project Budget and Financing Approval

Board approval of a project budget and financing plan (including pro forma financials, debt/operating expenses ratios, pledges, strategic facilities fees, and other material financial information) is required for a major project. This approval may be requested only after completion of the design and planning process and may be requested concurrently with approval for construction.

### 2.3.1.3 Construction Approval

Construction approval is required to proceed with the construction of a major project. In order to obtain Board approval for construction of a major project, the Board must approve the project budget and financing plan. This approval may be requested concurrently with approval of the project's budget and financing plan.

### 2.3.1.4 Final Approval – Financing and Incurrence of Debt

Approval for financing capital projects via the issuance of bonds, or incurrence of any other indebtedness, is required pursuant to Board policy V.F. for a project that has previously received approval for construction. (All other projects financed entirely without indebtedness do not need separate approval for financing.) The Board will not consider concurrent requests for approval for construction and debt financing for the same project. Therefore, institutions seeking approval for project debt financing must bring a request for said approval to a Board meeting subsequent to the meeting at which project construction is approved.

## **2.4 Public Works Bidding Levels**

### **2.4.1 Authority**

Idaho Code: Title 67 - State Government and State Affairs; Chapter 28 - Purchasing by Political Subdivisions.

### **2.4.2 Bidding Not Required**

IC 67-2803 - When a political subdivision contemplates an expenditure to procure public works construction valued at less than fifty thousand dollars (\$50,000), there are no requirements for bidding.

### **2.4.3 Abbreviated Bid Process**

IC 67-2805(1)(a) - When a political subdivision contemplates an expenditure to procure public works construction valued at or in excess of fifty thousand dollars (\$50,000) but not to exceed two hundred thousand dollars (\$200,000), the solicitation for bids for the public works construction to be performed shall be supplied to no fewer than three (3) owner-designated licensed public works contractors by written means, either by electronic or physical delivery. The solicitation shall describe the construction work to be completed in sufficient detail to allow an experienced public works contractor to understand the construction project the political subdivision seeks to build.

### **2.4.4 Formal Bidding Process**

IC 67-2805(2)(a) - When a political subdivision contemplates an expenditure to purchase public works construction valued in excess of two hundred thousand dollars (\$200,000), the purchase of construction services shall be made pursuant to a competitive sealed bid process with the purchase to be made from the qualified public works contractor submitting the lowest bid price complying with bidding procedures established by the bid documents.

## **2.5 Building Codes / Authorities Having Jurisdiction**

### **2.5.1 Division of Building Safety**

The State of Idaho, Division of Building Safety (DBS) is the Authority Having Jurisdiction (AHJ) for adopted building codes. The Design Professional is encouraged to communicate with DBS directly regarding code questions and interpretations. The Design Professional will officially transmit completed documents to DBS. The Owner will pay the DBS plan check fee and coordinate corrective action to the code review issues. DBS will issue the building permit and conduct field inspections for code compliance.

University of Idaho building projects are not subject to local building codes or code officials.

University of Idaho projects are not subject to city or county planning and zoning requirements.

### **2.5.2 State Fire Marshal**

The State Fire Marshal of the Department of Insurance has plan review authority for the Uniform Fire Code. The Division of Building Safety will route the submitted final plans to the State Fire Marshal for review. The State Fire Marshal works closely with local fire departments, even though local fire departments do not have jurisdiction for State owned facilities. The Design Professional and Contractor will be expected to coordinate site access and other issues with the local Deputy State Fire Marshal and local fire department where applicable.

### **2.5.3 Americans with Disabilities Act (ADA)**

Design Professionals and consultants are required to review the applicable requirements of ADA and the International Building Code regarding accessibility and to incorporate them into the design. The University may have projects where disability access or special needs requirements exceed those outlined in the ADA.

## **2.6 Insurance Carrier Advisory Review**

The University of Idaho is partnered with an insurance carrier that shall be included in courtesy / advisory reviews of all new building construction, major renovations and/or remodels on UI properties. The UI Project Manager shall work through the University of Idaho Risk Management and Insurance Office to coordinate scheduled reviews of the design documents with the designated engineering lead at the insurance vendor. All documentation and correspondence between the insurance vendor and the UI Project Manager shall be coordinated by, and flow through, the UI Risk Management office. Reviews shall be coordinated at each major design phase as applicable.

## **CHAPTER 3 - CAMPUS PLANNING and INFORMATION RESOURCES**

The following links are provided for Design Professionals to be aware of broader campus planning and information resources that are available outside of these guidelines. Design Professionals and Contractors are encouraged to review these resources as they provide supplemental information and/or may provide valuable information, insight, and background into the development of campus projects and the issues impacting them.

### **3.1 Long Range Campus Development Plan**

The LRDCP is a robust planning document that has provided guidance campus planning, growth and development for nearly two decades.

<https://www.uidaho.edu/dfa/budget-and-planning/aes/campus-development-plan>

### **3.2 Administration Building Preservation Master Plan**

A master plan outlining the requirements for renovation projects within the Administration Building, the primary intent of which is to restore the original character of the building in iterative steps.

<https://www.uidaho.edu/infrastructure/facilities/info-requests/forms>

### **3.3 Campus Exterior Signage and Wayfinding Master Plan**

Master plan and design guide for all exterior signage and wayfinding on the main Moscow campus and at extension campuses and research sites around the state.

<https://www.uidaho.edu/infrastructure/facilities/info-requests/forms>

### **3.4 Building Management Controls Standard**

Standards document for HVAC Controls and Building Automation Systems

<https://www.uidaho.edu/infrastructure/facilities/info-requests/forms>

### **3.5 Building Metering Standards**

Guidelines for building utilities metering on campus.

<https://www.uidaho.edu/infrastructure/facilities/info-requests/forms>

### **3.6 Utilities and Engineering Services**

Information on campus utilities and energy programs.

<https://www.uidaho.edu/dfa/division-operations/utilities/data>

### **3.7 Interactive Campus Map**

An interactive map of the University of Idaho campus that displays spatial information about buildings, addresses, parking, trees, campus construction and more.

<https://www.uidaho.edu/dfa/budget-and-planning/aes/campus-maps>

### **3.8 Parking Map**

Learn where to park and which permits are required for each lot.

<https://www.uidaho.edu/dfa/budget-and-planning/aes/campus-maps>

### **3.9 University of Idaho Sustainability Center**

<https://www.uidaho.edu/current-students/sustainability-center>

### **3.10 Seismic Evaluation and Report for General Education Buildings**

(Coordinate with UI PM or UI CAD Manager for access to the report.)

### **3.11 Office of Information Technology Structured Cabling Standards**

<https://www.uidaho.edu/-/media/UIDaho-Responsive/Files/oit/standards/data-security/network-connectivity/u-of-i-structured-cabling-standards.pdf>

### **3.12 University of Idaho Brand Resource Center**

UI Communications and Marketing resource for proper use and application of University branded logos, word marks, colors, etc ...

<https://www.uidaho.edu/brand-resource-center>

## **CHAPTER 4 - STANDARD DESIGN ELEMENTS & DETAILS**

The University of Idaho implements numerous standard features and elements into campus design. This is especially applicable to exterior spaces, where standard details help to preserve design continuity and context across campus.

### **4.1 Standard Design Elements**

The Design Professional shall implement the following elements and features, where applicable, into the design of all new buildings and major renovations. Coordinate with UI PM.

#### **4.1.1 Lactation Rooms**

Provide lactation rooms in all new construction and major remodels unless a lactation room is already provided in the structure being remodeled. On smaller projects or remodels, if an existing building does not have a lactation room, then the UI PM and Design Professional shall consider the integration of a lactation room into the project where it makes reasonable sense to do so. Lactation Rooms should provide sufficient space for a chair and side table. Include a sink, counter and space for an undercounter refrigerator.

#### **4.1.2 Family Restrooms**

Provide at least one family restroom in all new construction and major remodels, especially where the IBC may not require one for the occupancy type and/or occupant load. At larger projects, consider adding more than one family room (if only one required) depending on the size of the project.

#### **4.1.3 Nodes and Spaces for Students**

The UI PM and the Design Professional shall consider designing and integrating informal “found” space or nodes, when possible, in general education buildings to create student study space, gathering areas or

comfortable spaces to “camp” between classes. These are often carved out of corridors and hallway areas, or perhaps exist in widened spaces or nooks in window areas. This consideration shall extend to smaller remodels and renovations, especially in existing buildings where little student space is provided.

#### **4.1.4 Mail Rooms**

A central mail receiving room will be provided in each building. The mail room should be located in a semi-secure, non-public area, and may be incorporated with other functions such as a copy or break room. The mail room must be located on the same floor as, and somewhat adjacent to, the main delivery entrance to the building. Campus Mail Services will not deliver building mail to alternate floors in the building.

#### **4.1.5 Recycling Rooms and Alcoves**

A central recyclables collection and storage room should be provided in every building. The central recycling storage room should be located on the same floor as, and adjacent to, the main delivery entrance to the building.

Care should be taken to provide alcoves and/or other areas for recycling containers on each floor of the building and in any spaces that generate considerable waste. Recycling containers should be visible and easy to find, but not sitting directly entrance lobbies or in the walking path of major corridors.

(Refer to Section II – Construction Standards, “Division 32 – Exterior Improvements” for information regarding exterior recycling container and solid waste container space requirements.)

#### **4.1.6 Vending Areas**

Provide a vending area in each building that is in a convenient location, but not necessarily clearly visible from the main entries and circulation corridors. Locate vending machines where vending operations and motor noise will not disrupt adjacent offices or classrooms. Vending rooms should contain power and data (debit / credit card support) for machines. The use of vending machines that require drains and/or water supplies is heavily discouraged.

#### **4.1.7 Materials Storage and Filter Rooms**

Provide a room or space dedicated to the storage of overstock items, spare parts, and/or other equipment required for servicing the building. This room will be assigned to Facilities Maintenance and Operations and is not net assignable departmental space. It will be at least 100 square feet. It will be furnished with several outlets and shelf standards or shelving units along one entire wall.

Provide a room or space dedicated to the storage of HVAC filters. This space will be large enough to store one complete change of filters and should be on the same level as the mechanical room which contains the air-handling equipment. It should be accessible by elevator.

#### **4.1.8 Custodial Facilities**

All new and renovated facilities will have a Custodial Closet with a mop sink on each floor; centrally located as much as possible. Custodial spaces shall be separate rooms and not share space with mechanical rooms or communications closets. These should be a minimum of 75 square feet. Each should be provided with a mop sink, several outlets and shelf standards along one entire wall. Provide clear floor space for an industrial floor cleaner. The following items should be considered in the building design:

- Water coolers and similar equipment should be wall-hung to allow for machine cleaning of floors.
- All water closets should be wall-hung to allow for ease of cleaning in restrooms.
- Corridors should allow for a clean sweep by industrial size cleaning machines.
- Avoid mixing floorings, i.e. carpet and tile, where there are no clear dividing features.
- Ledges and/or other features that collect dust in hard to reach spaces should be avoided.
- Exclusive of any acoustical treatments, walls should be washable with non-porous surfaces.
- Refer to “Division 9 – Finishes” for additional requirements.

#### **4.1.9 Communications Rooms**

Every building will be provided with a communications distribution room on each floor. Size and location to be determined during the programming and design phase in coordination with the UI OIT department. Rooms will have suitable conduit access and all wall surfaces will be covered with fire-rated plywood

backing. Use non-static complaint floor finishes. Communications rooms should be stacked on multiple floors for ease of building distribution. (Refer to “Division 27 – Communications” for additional information.)

#### **4.1.10 Building Security**

The following security requirements shall be considered in all new building, remodel or renovation projects:

- Offices, Classrooms and Laboratories  
Offices, Classrooms and Laboratories have special security needs. (computers, AV equipment, specialty research equipment, etc). At a minimum, walls that adjoin corridors or other public access spaces must extend to the overhead structure. Consider extending all walls at classrooms and offices to the structural deck above for security and sound control. All walls in laboratory spaces will extend to the structural deck above.
- Access Control  
Card swipe (Vandal Card) access systems should be installed at all major building entrances and at larger office suites, laboratories and/or specialty rooms as applicable.
- Security Cameras  
Install safety and security cameras at building entries, corridors and stairwells. Camera locations will be coordinated with the UI Campus Security office. (Refer also to Division 28 – Electronic Safety and Security)

## **4.2 Standard Details**

Design Professionals shall review the below list of standard drawings and details, and coordinate with the UI PM regarding the proper use of the details, when applicable, in a project. The DP can request electronic or pdf files of the standard details from the UI PM or UI CAD Manager.

### **4.2.1 Interior Details:**

#### Dedication Plaque

UI preferred dedication plaque template and layout. Use where required for new construction and/or major renovations. The template allows for some customization for each project.

### **4.2.2 Exterior Details**

#### Fixed Bollard

UI standard pipe bollard. Includes dimensions, paint color, and reflective tape colors / layout.

#### Removable Bollard

UI standard removable pipe bollard. Includes dimensions, paint color, and reflective tape colors / layout.

#### Bike Rack

Typical UI standard bike rack.

#### Concrete Light Pole Base

Typical concrete light pole base for parking and pedestrian lighting poles around campus. (Refer also to Section II –Construction and Technical Standards for standard light poles.)

#### Information / Bicycle Parking Shelter

Standard small shelter that is intended primarily for covered bicycle parking, that has also been implemented for campus Information shelters and other uses as applicable.

#### Railings – Gothic Arch Version

Typical railing used on exterior stairs, ramps, and other site elements in the historic Administration Building neighborhood. This railing features a gothic arch pattern that is repeated in the campus Building ID signs and other exterior elements. The historic Administration Building neighborhood is roughly delineated as those areas bordering the Administration Building and the Administration Building Lawn. This railing pattern should not be used at guardrails as they do not meet code requirements for that use. All use of the gothic arch railings should receive prior approval from the AES Director.



### Railings – Standard “I” Version

Alternate railing design used in various exterior areas around campus. The rail features an “I” in the intermediate rail pattern. The most recent version of this railing meets current IBC requirements for guardrails. Use of this railing is not required but can be considered where applicable. Use of the “I” rail should be coordinated with the UI PM and AES Director.

### Exterior Trash Receptacle

The UI employs a standard trash receptacle for exterior campus spaces. The trash receptacle is Model DR-1200 as manufactured by Doty & Sons Concrete Products. 51” wide x 26” deep x 41” high. Tan blend pea gravel exposed aggregate finish. Heavy-duty steel double hinged lid powder coated chestnut brown. Includes three 30-gallon rectangular, hard plastic liners. UI standard vinyl recycling messaging shall be applied to the lids. Coordinate specifications with UI PM.

### Banner Poles

The UI has implemented banner poles in certain neighborhoods on campus to highlight key pedestrian walkways and/or as components of traffic calming solutions. The use of banner poles in campus projects should be coordinated and approved by the Director of Architectural and Engineering Services. All banner poles shall be constructed similarly to match the campus standard design language. There are two standard banner pole heights. The taller banner poles shall be used in sidewalks or planters that are close to streets and other vehicular areas. The shorter banner poles may be used in areas where there is pedestrian traffic only. The UI PM and UI CAD Manager can provide detailed information for banner pole construction. (Refer also to Division 32, Section 32 33 00 for more information.)

## **4.3 Exterior Signage and Wayfinding**

The UI maintains a standard inventory of exterior sign types that are required to be used across campus and at UI properties statewide. These are outlined in the Campus Sign and Wayfinding Master Plan referenced and linked in “Chapter 2 – Campus Planning and Design Resources”. The UI is in the process of implementing the build-out of the signage master plan in iterative stages as funding becomes available. New signage shall be included in construction projects as applicable.

The following sign types have been fully detailed and, to varying degrees, implemented across campus. Drawings for each sign type include concrete foundation / pier, steel frame, signs panels, and standard text / font / symbol layouts and dimensions. The UI PM or Cad Manager can provide updated details upon request from the Design Professional.

- **DR** - Vehicle Directional Sign
- **PW** - Pedestrian Walkway Sign
- **FA1** - Facility / Building ID Sign, Free Standing (single name)
- **FA2** - Facility / Building ID Sign, Free Standing (dual names)
- **FA3** - Facility / Building ID Sign, Building Mounted
- **PK1** - Parking ID Sign, Small (for single spaces or a small range of spaces)
- **PK2** - Parking ID Sign, Large (for parking lot ID or entry)
- **IN** - Interpretive Sign
- **AC** - Accessible Pathway Sign
- **EX1** - Extension Campus, Large, Free-Standing Sign
- **EX2** - Extension Campus, Small Storefront Sign

## **CHAPTER 5 - ROLES and RESPONSIBILITIES**

### **5.1 Individual Roles**

#### **5.1.1 Architectural and Engineering Services (AES)**

Architectural and Engineering Services (AES) is a department in Facilities Services, under the Division of Finance and Administration, that provides to the UI the full range of architectural services related to

the planning, programming, design, document production, cost estimation, bidding, and construction observation of capital projects and maintenance, alteration, and repair projects. AES is the department on campus that contracts with technical consultants, bids & manages construction contracts, coordinates with the State of Idaho Division of Public Works for legislative appropriated design and construction efforts and maintains the historical archive of documents and operations manuals for all campus facilities.

### **5.1.2 Vice President, Division of Finance and Administration (VP, DFA)**

The Vice President of Finance and Administration is the chief financial executive in charge of numerous campus departments to include Facilities, and by extension, Architectural and Engineering Services. The VP, DFA has signature authorization on all contracts, agreements, and change orders over \$250,000.

#### **1.11 Assistant Vice President, Facilities (AVP Facilities)**

The Assistant Vice President, Facilities is in charge of Facilities Services, and by extension, Architectural and Engineering Services. The AVP Facilities has signature authorization on all contracts, agreements, and change orders under \$250,000. The AVP Facilities may designate signature authority at similar limits to the AES Director. The AVP Facilities reports directly to the VP, DFA.

#### **1.12 Director of Architectural and Engineering Services (AES Director)**

The Director of Architectural and Engineering Services (AES Director) oversees the design and construction operations for the University of Idaho, oversees the project requisition and approval process with the State of Idaho, is the supervisor for all AES staff and serves as the Campus Architect. The AES Director reports directly to the AVP Facilities.

#### **1.13 UI Project Manager (UI PM)**

The UI Project Manager (UI PM) reports to the AES Director, and is typically an architect, engineer or specialist assigned by the Director of AES to manage a specific design and construction projects.

#### **1.14 UI Construction Manager (UI CM)**

The UI Construction Manager reports to the AES Director and provides oversight over all construction on campus including project scheduling, construction logistics, campus safety related to construction, quality control, coordination with outside agencies, development of campus standards and policies related to construction, and enforcement of same.

#### **1.15 UI Construction Inspector (UI CI)**

The UI CI reports to the UI CM, assists the UI PM during project construction, provides regular inspections of the work and engages with the contractor to facilitate construction coordination, site access, and project security.

#### **1.16 UI Construction Contracts Supervisor (UI CCS)**

The UI Construction Contracts Supervisor prepares and processes all contracts, change orders, and pay applications for the AES department.

#### **1.16 UI CAD Manager**

The UI CAD manager supervises the CAD staff and interns and provides general support to the AES unit. Responsibilities include operational management of the department CAD hardware / software, CAD standards, standard details, GIS information, building reference plans and as-built drawing archives.

#### **1.17 UI Stakeholder Group (UI SG)**

The UI Stakeholder Group is the group of individuals, typically UI employees, who have input towards, or a vested interest in, any particular project. This group will vary from project to project and typically consists of the individuals who have requested and/or are funding the construction project. The UI SG might consist of a committee of selected individuals who are tasked with ensuring that the project meets the strategic requirements of the University. The Stakeholder Group may be comprised of UI staff, professors, student groups, department heads, college deans, campus executives, or any mix thereof.

#### **1.17 Design Professional (DP)**

The Design Professional is any architect, engineer or specialty consultant contracted to provide design

consulting services with the University of Idaho.

### **1.17 Design Professional Project Manager (DP PM)**

The Design Professional shall designate a representative to act as Project Manager for the DP. The DP PM will be the main point of contact between the UI and the DP's design team.

## **5.2 Typical Individual Responsibilities**

(A specific project may require additional and/or differing responsibilities.)

### **5.2.1 UI Project Manager (UI PM)**

- Set up the project in the AES management software and continuously manage purchase orders, project budget, project schedule, expenditures, funding sources and project/status updates.
- Assist the UI SCC in setting up physical project files and make sure critical information is filed during the project.
- Manage all communications and information distribution to all the various UI parties involved in the project, including: UI internal progress document review, UI internal shop drawing review, updates to the UI Stakeholder Group and making sure appropriate UI personnel are invited to meetings.
- Outline the initial project scope, schedule and budget under the guidance of the AES Director and UI Stakeholder Group.
- Conduct the process to identify and select a Design Professional. (Process will vary depending on project size and complexity.)
- Conduct a pre-design kickoff meeting and/or investigation of the project with the DP to review scope, intent, existing data, existing studies, initial assumptions, and any other factors that might be part of the project planning.
- Negotiate fee proposal with the DP and prepare the drafts of the DP Agreement for completion and processing by the UI CCS.
- Coordinate, hire and oversee completion of any required surveys, testing and commissioning as applicable.
- Provide day-to-day management of the project as required to provide information, support and overview to the DP. Provide continuous oversight of project schedule and DP progress. Attend all progress meetings and monthly meetings and distribute the DP's meeting minutes to UI entities and the UI SG as applicable.
- Review and approve progress documents submitted by the DP and coordinate review of progress documents with other UI entities and departments as necessary. Compile all UI progress review comments, forward to the DP and monitor document development to make sure all UI comments and requirements have been incorporated into the project.
- Coordinate insurance carrier advisory reviews through the UI Risk Management Office at all major design phases.
- Coordinate review of any impacts to campus utility systems with the utility concessionaire partner (McKinstry / SPUI).
- Review and approve applications for payment from the DP, Contractor, and any other vendors on the project. Approve changes in scope of services, construction proposal requests, schedules, budget, fees, and oversee any subsequent amendments or change orders to the various Agreements.
- Coordinate acquisition of furniture and equipment for the project as necessary.
- Coordinate moving and logistics related to the relocation of UI occupants out of the construction or remodel area when required.
- Arrange for the advertising, receipt and opening of bids in coordination with the DP.
- Assist the UI CCS in preparation and review of Intent to Award, contract review, and Notice-to-Proceed.
- Monitor construction progress and manage cost and schedule.
- Facilitate resolution of project issues, disputes, or claims.
- Monitor project close-out process in coordination with the DP.
- Submit warranty claims to the contractor during the warranty period. Attend final warranty walk-thru at end of warranty period.
- Close out project and purchase orders in the AES management software system and make sure any UI capital project budgets are closed and any remaining funding returned to source budgets.

### **5.2.2 UI Construction Manager (UI CM)**

- Provide technical support and advice, when needed, to the UI PM and UI CI.
- Provide constructability review of drawings for conformance with UI standards.
- Review and approve project lay down, staging, site access, parking, phasing, sequencing, and other logistics as required.
- Attend preconstruction meetings, review contractor work plans and safety plans. Facilitate construction coordination with outside entities (when required) such as the City of Moscow, Moscow Fire Department, and the Deputy State Fire Marshal.
- Monitor construction quality control.
- Assist the UI PM and UI CI in evaluating, processing and avoiding construction period disputes.

### **5.2.3 UI Construction Inspector (UI CI)**

- Visit the project site at regular intervals and observe and report activities. Report non-conforming conditions to the UI PM and DP.
- Coordinate contractor parking, site access, keys, vandal card access, etc ...
- Participate in Pre-Construction meeting, all monthly meetings, substantial completion inspections and warranty walk-through.
- Coordinate any construction support required by UI Building Trades or Landscape staff. Coordinate on-site construction inspection by UI Building Trades or Landscape staff. Coordinate Owner Training sessions with appropriate personnel.
- May assist in performing code inspections at the project site if requested by the Division of Building Safety.

### **5.2.4 AES Director:**

- Review initial project request and requirements and assign project to a UI project manager.
- Provide technical support and counseling, when needed, to the UI PM and UI Stakeholder Group.
- Provide design intent, relevant campus planning issues, and strategic goals for the project.
- Monitor PM activities to assure compliance with project procedures, project requirements, design goals, project schedule and project budget. Approve project at each stage.
- Assist in avoiding, evaluating and processing design phase and construction period disputes.

### **5.2.5 UI CAD Manager:**

- Provide support to the UI PM and provide access to the campus drawing archives for the DP.
- Archive O&M Manuals, As-Built Drawings and Specifications in the physical archive. Create pdf as-built file for the electronic database.
- Create new Building Reference Plans (BRP's) at new buildings (where applicable) or update existing BRP's to reflect plan changes resulting from the project. The UI CAD Manager will request CAD files from the DP to assist in the creation of BRP's.

### **5.2.6 Design Professional:**

- Be fully knowledgeable of the University's consultant agreements, contractor agreements and the UI Design Guidelines and Construction Standards. Understand and provide the services specifically included or required by the project scope and the applicable guidelines.
- Attend the initial design meeting. Gather all information and existing conditions. Prepare scope of work document and fee proposal.
- Engage in a cooperative design process with the Owner. Produce all required design and bidding documents. Coordinate all work of sub-consultants.
- Provide updated project cost estimates and schedules at the end of the Schematic Design, Design Development, and Construction Document phases.
- Submit written requests for any changes in scope of services, schedules, budget, or fees to the UI PM for approval.
- Conduct design review meetings, Pre-Bid meeting, Pre-Construction meeting, and monthly construction meetings at the direction of the UI PM. Have a representative authorized to make decisions at all scheduled meetings. Create and distribute agendas for all meetings. Record and distribute meeting minutes for all meetings.
- Shall have awareness of, and familiarity with, the Division of Building Safety plan review and permitting process. Submit plan review application and documents to DBS, reconcile plan review comments, and include DBS approved plans and specification as bid documents. Initiate and obtain plan reviews and approvals from any other applicable regulatory agencies.

- Manage bidding process including distribution of drawings to bidders, updating the plan holders list, running the pre-bid meeting, answering bid period questions, reviewing substitution requests, creating and distributing addenda, and participating in the bid opening.
- Review and coordinate construction activities with the UI PM and CM. Provide written interpretations of Contract Documents as required.
- Conduct site observations at intervals as arranged by the UI PM. Distribute site observation reports.
- Review contractor payment requests, recommend payment to UI PM or return to contractor for corrections and resubmittal.
- Prepare and process supplemental instructions, RFI's, proposal requests, construction change directives and change orders. Review all shop drawing submittals. Keep status logs of all the aforementioned items for review at monthly meetings.
- Conduct project punch list, substantial completion, and closeout.
- Provide as-builts, CAD plans and/or Revit model at end of project for UI archives.
- Participate in warranty walk at 11-months post substantial completion.

### **5.3 Communications between Design Professional and University**

Correspondence and communication between the University and the Design Professional, on all issues, shall be channeled through the UI PM and the DP PM.

Authorization may be given by the UI PM for the Design Professional, or one of the DP's sub-consultants, to communicate directly with certain UI personnel or partners in special situations or circumstances to expedite critical design issues and/or to avoid communication delays. This action does not authorize additional work, changes in scope or changes in program unless so approved by the UI PM and DP PM. All such secondary communications shall be copied to the UI PM and/or DP PM as applicable.

## **CHAPTER 6 - SURVEYS, TESTING and COMMISSIONING**

### **6.1 Site Surveys**

The Owner shall hire a licensed surveyor or civil engineering firm to provide a site survey for the project when applicable. The survey shall include all physical features, utilities, benchmarks, property lines, topography and spot elevations.

The UI PM may coordinate with the UI DP to confirm extents of survey, required data, and any other special information that might be required. The DP shall review the survey to make sure all information appears to be included.

An electronic CAD file of the survey will be provided to the DP for use in the development of the site plans and civil plans.

### **6.2 Hazardous Materials Surveys**

The Owner will coordinate with the University of Idaho, Department of Environmental Health & Safety for an initial ACM / Hazardous Materials review of the project. If EHS determines that the scope of work may be beyond the resources of EHS personnel, then the UI PM will hire a licensed environmental / industrial hygiene firm to provide a detailed survey.

If hazardous materials are discovered, then the UI PM and the DP will formulate a plan for remediation of hazardous materials based on the quantity and scope involved. For larger remediation efforts, the UI will hire an environmental / industrial hygiene company to provide third party oversight and clearance testing during abatement.

### **6.3 Soils Investigation and Engineering**

The Owner will hire a geotechnical engineer to perform investigative soils testing and to provide a detailed geotechnical report for the project (where applicable). If the DP's structural and civil consultants determine that additional and/or special soils reinforcement is required, then the Owner may retain the geotechnical engineer for additional services to support design.

The soils report and boring log will be referenced and included as part of the contract documents and either included as an appendix to the specifications or otherwise made available to prospective bidders and contractors.

#### **6.4 Commissioning**

The University of Idaho, unless otherwise authorized by the UI PM, requires commissioning on all projects. The scope of the commissioning process shall be determined by the size and complexity of the project. The DP shall be required to enhance project specifications as necessary to include the additional testing requirements.

On larger projects, a qualified Commissioning Authority (CA) will be selected and contracted by the Owner. The CA will establish owner requirements, develop commissioning requirements, participate in the design process and complete testing and verification procedures as outlined below in the Enhanced Commissioning Process. On smaller projects, the UI PM and DP will review the project requirements and determine whether a modified, or basic, commissioning process is to be included as part of the DP's scope of work.

Under either scenario, the DP shall include project commissioning requirements as line items in both the project schedule and project cost estimates. The Contractor shall similarly be required to include commissioning related tasks as individual line items in the contractor's Critical Path Schedule. The DP shall outline these requirements in the project specifications.

##### **6.4.1 Basic Commissioning Process**

It is essential that all identified building components and systems be proven operational before the University occupies any portion of the building or assumes responsibility for its operation. The U of I will expect the Design Professional's sub-consultants to certify that condition. The certification must be provided before the owner's training takes place and before the contractor calls for a Substantial Completion inspection. The DP will witness, on site, the operation of all required components and systems. The DP will then provide the owner with an executed Commissioning Certificate.

##### **6.4.2 Enhanced Commissioning Process (where applicable)**

The scope of commissioning will be variable and will depend on the scope and complexity of the project. On larger projects, the UI's preference will be to pursue an enhanced commissioning process. Enhanced commissioning will be required on all LEED projects. Enhanced commission will include the following steps:

###### 6.4.2.1 Establish Systems' Acceptance Criteria:

The Owner, Commissioning Authority (CA) and DP coordinate to establish the acceptance criteria for systems' performance and maintainability.

###### 6.4.2.2 Design Review:

The Commissioning Authority (CA) will review the schematic design, design development, and construction document submittals with a focus on constructability and compliance of the design with the owner's documented criteria for systems' acceptance. The CA will develop Verification of Completion forms for the systems to be commissioned.

###### 6.4.2.3 Contractors' Submittal Review:

Contractors' submittals are reviewed by the Commissioning Authority (CA) with the primary focus on obtaining the background necessary for developing comprehensive and fair functional test procedures. Also allows the CA to identify performance related installation issues before construction progress makes them more difficult and expensive to resolve.

###### 6.4.2.4 Construction Review

The CA monitors the systems installation to identify commissioning related installation issues before construction progress makes them more difficult and expensive to resolve. These reviews also enable the CA to obtain the background necessary for conducting comprehensive and fair functional test procedures.

###### 6.4.2.5 Develop Functional Test Procedures

The functional testing program objectively verifies that the building systems perform interactively in accordance with the Project Documents. Written repeatable test procedures, prepared specifically for each project, are developed during this phase. These tests are designed to functionally test components and systems (specified for testing) in all modes of operating conditions.

#### 6.4.2.6 Contractor's Checkout, Startup and Verification of Completion

The Contractor thoroughly performs final checkout and startup procedures to verify that the systems have been put into operation in compliance with the Project Documents and are operating in accordance with the functional test procedures. The Contractor documents this phase of the commissioning process with startup and certification reports as specific for equipment, and Verification of Systems Completion forms that are developed by the CA during design phase.

#### 6.4.2.7 Functional Testing Procedures

Functional test procedures are performed, and performance issues are identified and resolved.

#### 6.4.2.8 Substantial Completion and Systems Acceptance

Substantial completion and systems acceptance are awarded by the Owner based on completion of the Functional Testing Phase and evidence that all systems are in compliance with the Functional Test Procedures.

#### 6.4.2.9 Final Commissioning Report

The CA provides the owner with the Final Commissioning Report that outlines commissioning results, deficiencies, corrections, functional testing reports, final balancing reports, field test reports and a description of any deferred testing that may be required.

#### 6.4.2.10 Acceptance

The Owner provides acceptance of the work based on the Final Commissioning Report.

### **6.4.3 Full System Run Test**

Following completion of the project, and immediately prior to the Substantial Completion inspection, a full building, functional performance test will be performed. This will be 96-hours in duration, and all contractors, subcontractors, factory representatives and consulting engineers will be in attendance.

The 96-hour test run shall be made when all field equipment is installed and the system is calibrated and running, and when all other building systems (including drywall, windows, doors, etc.) are complete. This period is intended to demonstrate the operation of the complete building

### **6.4.4 Owner Training**

Owner training sessions will be coordinated and supervised by the CA. During the design phase the Commissioning Team shall determine which systems require selected contractor/manufacturer/supplier training sessions and which sessions, if any, should be video-taped. These will be so specified in the construction documents. The contractor and specified manufacturers' representatives or suppliers shall be responsible for conducting selected training sessions, providing handout information at these training sessions, and video-taping sessions as specified.

### **6.4.5 Certification**

For each system identified within the commissioning scope, a Commissioning Certificate of Completion will be completed and signed by each trade listed, indicating that all commissioning work has been completed and that all systems are installed according to the contract documents, the manufacturer's installation instructions, and the requirements of the functional test procedures. The Contractor shall further certify that all adjustment, lubrication, alignment and startup procedures have been carried out.

### **6.4.6 Components and Systems for Commissioning**

A detailed scope for commissioning shall be clearly outlined at the beginning of each project. Commissioning Certification may be required on any combination of the following components and systems:

#### 6.4.6.1 Individual Components

- steam and hot water generators
- heat exchangers
- cabinet heaters and fan-coil units
- air handlers
- variable air volume boxes and terminal devices
- motorized dampers, including face-and-bypass
- motorized control valves and steam stations
- pressure reducing valves
- pumps
- humidifiers
- condensate traps
- transformers
- emergency generators

#### 6.4.6.2 Interrelated Systems

- building management control systems
- variable frequency drives and starters
- acid neutralization systems
- fire alarm and detection systems
- fire sprinkler systems
- security systems
- automated electrical switching systems
- lighting controls
- elevator operation, including DLIS testing
- elevator smoke doors

#### **6.4.7 Division of Public Works**

The Idaho Division of Public Works (DPW) requires commissioning of all state-funded projects over \$2 million in scope. An independent Commissioning Authority will be hired on all projects over \$5 million in scope. The commissioning is largely limited to mechanical work (Division 23). Some electrical elements (Division 26) may be negotiated.

The University of Idaho's commissioning process will mirror many of the requirements outlined in the State of Idaho, Division of Public Works Commissioning Guidelines, which can be found at the following location:

<https://dpw.idaho.gov/docs-forms-guides/>

The University of Idaho will increase or decrease commissioning scope and requirements as applicable to best serve individual projects.

#### **6.4.8 Testing & Balancing**

Third-party testing and balancing will be required on all projects. Refer to Section II Technical and Construction Standards, "Division 23 – Heating, Ventilation and Air Conditioning" for additional information and requirements.

## **CHAPTER 7 - SUSTAINABLE DESIGN**

### **7.1 University Policy**

University of Idaho, Administrative Procedures Manual  
Section 40.03 – New and Major Renovation Building Policy, Subsection "B":

#### **7.1.1 General**

It is the policy of the University to finance, plan, design, construct, manage, renovate and maintain its facilities in a sustainable fashion. While construction of sustainable buildings potentially incurs additional first costs – both in terms of design fees and construction costs, sustainable buildings have reduced operating costs. The University recognizes that investments in sustainable building usually have short payback periods and yield substantial savings over the life cycle of the completed facility.



### **7.1.2 Sustainable Building Standard**

All new construction and major remodels (in excess of 50% of state replacement value) shall be certified as meeting or exceeding a Silver LEED rating or equivalent according to the latest edition of the US Green Building Council's LEED rating system and accompanying Reference Guide. Design and project management teams are encouraged to meet higher LEED rating levels such as Gold or Platinum. Use of an alternative green building standard may be allowed provided a clear rationale is outlined as to why the alternative standard should be considered equivalent or superior to LEED Silver. Particular emphasis should be placed on achieving the LEED points related to optimizing energy performance, advanced commissioning, and measurement & verification.

### **7.1.3 Responsibility**

This policy applies to all university divisions, departments, offices and their contractors responsible for financing, planning, designing, developing, constructing, renovating and managing University-owned facilities and buildings, regardless of location. Where other state agencies (e.g., Division of Public Works or Idaho State Building Authority) have responsibility for delivering the construction or renovation project, the university will strive to work with the agency in developing and delivering a project meeting the standards outlined above.

### **7.1.4 Exemptions**

Buildings whose primary use is for agricultural or machinery storage, animal shelters, and similar uses are exempt from this policy until a LEED rating system is designed suitable to these types of structures.

## **7.2 LEED Certification Process**

For all projects that pursue LEED (or other green building) certification, the Design Professional (or a sub-consultant of the DP) will be expected to, in coordination with the UI PM, manage all facets of the LEED design and submittal process. This will include: planning, design charrettes, scorecard evaluation, coordination with UI entities, organization of supporting documentation, implementation of requirements in the drawings and specifications, monitoring of contractor submittals, upload of the Design Submittal, upload of the Construction Submittal, and response to USGBC comments.

The DP and the UI PM shall clearly define sustainable design and certification goals prior to the Scope of Work, Fee Proposal, and Agreement.

### **7.2.1 Areas of Emphasis**

The following subsections list areas of sustainable design that are strongly emphasized by the University of Idaho and should be carefully evaluated on each project, regardless of whether LEED certification, or other green building program, is integrated into the project.

#### 7.2.1.1 Bicycle Facilities

The UI endeavors to be a bicycle friendly campus and promote alternative means of transportation. Bicycle parking areas, covered bicycle parking, bicycle storage, and shower facilities should be considered where possible on all major projects.

#### 7.2.1.2 Reduced Parking Footprint

The University has made the intention and commitment to preserving the core of campus as a pedestrian-only zone with limited parking. All design projects shall support the LRDCP and long-term parking planning. Parking will be evaluated for each building and will be based on building use and location.

#### 7.2.1.3 Open Space Protection and Heat Island Reduction

UI's legacy of premier open space was created during the earliest years of campus development. Today the beautiful campus setting amidst expansive rural fields and campus green areas supports the vision as a residential campus of choice in the West. Refer to the UI "Long-Range Capital Development Plan" (referenced in Chapter 3) for further information on Open Space planning.

#### 7.2.1.4 Tobacco and Smoke Control

Smoking and tobacco products are prohibited everywhere on the University of Idaho campus.

#### 7.1.2.5 Reused & Repurposed Materials:

The Design Professional should always look for opportunities for reuse of existing building systems or installation of repurposed materials, including: the building shell, structural systems, finishes, fixtures, stair and elevator shafts, etc ...

#### 7.1.2.6 Building Envelope:

The building envelope should be designed to minimize heat loss and gain beyond the requirements of the energy code where possible. Building envelopes should avoid thermal bridging and provide high-performance cladding systems where possible. Specify systems and materials that are durable and appropriate to the local climate and weather conditions.

#### 7.1.2.7 Mechanical / Electrical Systems:

Specify HVAC and electrical systems that find the balance between energy efficiency, maintainability, and conformance with UI standard systems. Coordinate systems and controls to optimize building operation and reduce energy consumption. Lighting control systems and daylight responsive dimming shall conform to university standards and systems. Provide connection to campus central heating and chilled water systems whenever possible. Consider extended life cycle maintenance and material costs in all MEP systems design.

#### 7.1.2.8 Central Campus Systems

The University utilizes several central campus utility systems that contribute to sustainable energy strategies. These should be connected to and utilized whenever possible. These include:

- A central campus steam plant featuring biomass wood-fired boilers.
- A central campus chilled water system with two district chilling plants.
- A reclaimed water system that provides landscape irrigation for over 150-acres of campus.

#### 7.1.2.9 Construction Indoor Air Quality Management Plan

Whenever possible, the Design Professional should include requirements for construction indoor air quality management in UI projects. This is especially applicable to the protection of HVAC ductwork, systems and equipment from construction dust and debris. Smoking is not allowed on the UI campus and will not be allowed on construction sites.

#### 7.1.2.10 Daylighting and Quality Views:

Regardless of LEED requirements, all Design Professionals shall carefully consider natural daylighting, views, and connections to the natural environment in design projects.

#### 7.1.2.11 Commissioning, Metering, Measurement & Verification:

(When possible.) Provide enhanced energy commissioning requirements beginning with the establishment of energy / system goals in the Schematic Design phase and ending with post occupancy energy analysis. Provide permanent energy metering on every utility connected to a building utilizing the UI metering standards. Provide the capability to monitor and analyze post-occupancy performance in comparison to energy analysis predictions. Provide a 1-year post occupancy energy use analysis.

## **CHAPTER 8 - PLANNING and DESIGN PHASE**

### **8.1 Project Pre-Planning, Scoping and Agreement**

#### **8.1.1 Existing Program Data**

The UI PM will make available to the Design Professional all available program data for functional requirements. If program information is not available, a programming phase and/or feasibility study effort may be incorporated into the agreement as a preliminary or additional design service.

#### **8.1.2 Existing Project Data**

The Design Professional will be given access to all available existing project data to include: program, as-builts, studies, surveys, checklist(s), space standards, or other owner requirements. If a pre-design study

was undertaken prior to the project, that data will be made available to the Design Professional. Upon approval from the UI PM, the UI CAD Manager will provide the Design Professional temporary access to the electronic database of archived as-built drawings.

### **8.1.3 Project Budget**

The UI PM will be responsible for the overall project budget and shall provide the DP an initial estimated cost of construction (where applicable). In other cases, the project budget may be established after the Schematic Design Phase. The UI PM may elect to have the DP assist in the establishment of an initial project estimate through the completion of an initial programming and/or feasibility study provided as a separate or additional service.

### **8.1.4 Project Scheduling**

The project schedule shall be based on the planning, design, and construction requirements of the project and must consider required Regents funding authorizations (if required), the academic calendar, campus events, weather, DBS plan reviews, etc... The schedule shall allow sufficient time for owner reviews and presentations to the UI Stakeholder Group as required at each phase of the project.

### **8.1.5 Initial Pre-Design / Pre-Agreement Meeting**

The UI PM may schedule an initial “kick off” pre-design / pre-agreement meeting with the Design Professional and UI Stakeholder Group. Agenda will include: introduction of personnel, sub consultants, and other participants, review of project’s scope of work, budget, communications, project requirements, project goals, project schedules, and existing data.

### **8.1.6 Existing Conditions**

The Design Professional shall review existing as-builts plans, any pertinent studies, and other data with their subconsultants to assess the relationship between the existing and proposed project conditions. Following this review, the Design Professional and their sub-consultants will perform a site investigation to verify existing conditions.

After investigation of existing conditions, the Design Professional should recommend to the UI PM any supplemental surveys or studies that may be necessary. Site surveys and soil investigations will be contracted by the Owner.

### **8.1.7 UI Design Guidelines and Construction Standards**

The DP shall review the requirements of these Design Guidelines and Construction Standards, and understand the roles and responsibilities expected of the DP.

### **8.1.8 General Education Building Seismic Evaluation**

Design Professionals working on remodels, additions, or renovations to any general education buildings on campus shall review the “UI General Education Building Seismic Evaluation”, completed in 2012. The report outlines general seismic deficiencies for all general education building on campus, and outlines strategies for upgrades. These upgrades shall be incorporated into remodel and renovation work wherever applicable. Coordinate access to the report through the UI PM or UI CAD Manager.

### **8.1.9 Commissioning and LEED Requirements**

The UI PM and DP shall clearly establish project scope for LEED certification and commissioning as outlined in Chapter 6 and Chapter 7.

### **8.1.10 Scope Letter and Fee Proposal**

The Design Professional, having reviewed the project requirements, existing program data, existing project data, existing conditions, preliminary budget assumptions, preliminary schedule assumptions, LEED requirements, commissioning requirements and the UI Design Guidelines and Construction Standards, will submit to the UI PM a Scope Letter and Fee Proposal for the anticipated work. The UI PM will then review and negotiate with the DP until both sides are in agreement regarding the Project Scope and Fee for the work. The final revised Scope Letter and Fee Proposal will be bound into the Agreement.

### **8.1.11 Agreement**

The UI CCS will prepare the Agreement and issue two copies to the DP. The DP will assemble all required

paperwork, sign both contracts, and return the package to the UI CCS. The UI CCS will review the paperwork and then process the agreement for signature at the appropriate level. One original signed copy of the Agreement will be returned to the DP.

Typical formats for Agreements are as follows:

#### 8.1.11.1 Typical Design-Bid-Build

For mid-to-large size projects that follow the general Design-Bid-Build format, the UI will implement an AIA B101 – 2017: Standard Form of Agreement Between Owner and Architect. This agreement is further modified by standard UI Supplemental Conditions, which can be found in “Appendix A” of these guidelines.

#### 8.1.11.2 Non-Standard Scope

For mid-size to large projects that feature limited or irregular scope, special consulting requirements, or which may not follow the strict format of a Design-Bid-Build project, the UI may implement either an AIA B102 – 2017 Standard Form of Agreement Between Owner and Architect without a Predefined Scope of Work, or an AIA B104 – 2017: Standard Abbreviated Form of Agreement Between Owner and Architect.

#### 8.1.11.3 Letter Contract

For smaller projects, typically where consulting fees will be less than \$40,000, the UI PM may elect to implement a standard UI Facilities Letter Contract. A sample of the Letter Contract can be found in “Appendix A” of these guidelines.

Other AIA B-Series formats for Agreements may be implemented as required by the special circumstances of a particular project and as agreed upon by the UI and DP.

### **8.1.12 Additional Services**

The Design Professional shall not proceed with additional services or changes in the scope of services prior to receiving written authorization from the UI PM. Written authorization for additional services shall be provided via an Amendment to the Agreement.

### **8.1.13 Payment Applications**

The DP shall submit payment applications to the UI PM and UI CCS on a standard “Facilities Payment Application Form”. The first payment application shall start with “No. 1” and be labeled in order after that. Payment applications shall be submitted every month and may only include charges for work competed. No pre-payments for work or retainers are allowed.

The UI CCS will provide the DP a blank payment application form in MS Excel at the beginning of the project. A sample of the form is included in “Appendix A” of these guidelines.

## **8.2 Schematic Design Phase**

### **8.2.1 Schematic Design Meetings**

The DP shall plan on regular input from the owner during the schematic design phase and shall schedule update meetings, design charrettes and LEED charrettes (where applicable) at intervals appropriate to the project scope and design requirements. The UI PM will coordinate involvement of the Stakeholder Group or other UI personnel as applicable.

The DP will be expected to run the meetings, take thorough notes and distribute minutes of the meetings.

### **8.2.2 Schematic Design Approval**

The final schematic design documents should be accompanied by site plans, floor plans, elevations, a preliminary LEED plan (where applicable) and/or renderings as needed to accurately describe the design intent, as well as a project cost estimate and project schedule.

The UI PM will coordinate the UI insurance carrier advisory review of the schematic design package, as applicable, through the UI Risk Management office as outlined in Chapter 2, paragraph 2.6 of these Design Guidelines.

The Design Professional shall obtain documented approval from the UI before proceeding with the Design Development Phase.

### **8.3 Design Development Phase**

#### **8.3.1 Design Development Meetings**

The Design Professional shall schedule design development meetings with the UI PM at intervals appropriate to the project scope. At minimum, the DP shall plan to present a 50% progress set concurrent with continuing design activities. The UI PM will coordinate involvement of the Stakeholder Group or other UI personnel as applicable.

The UI PM shall coordinate design review and approval with the OIT Network Team, OIT Classroom Technology and Campus Safety and Security as applicable.

The DP will be expected to run the meetings, take thorough notes and distribute minutes of the meetings

#### **8.3.2 Design Development Approval**

A 100% Design Development presentation will be made to the University by the DP. The final deliverable package should include drawing documents and outline specifications as described in the AIAB101-2017 agreement along with a preliminary LEED scorecard and evaluation (when applicable). This will include a detailed construction cost estimate including any projected value engineering options and/or building bid alternate options that may be required to modify the estimate to comply with the Owner's budget.

The UI PM will coordinate the UI insurance carrier advisory review of the design development package, as applicable, through the UI Risk Management office as outlined in Chapter 2, paragraph 2.6 of these Design Guidelines.

The Design Professional shall obtain documented approval from the UI PM before proceeding with the Construction Document Phase.

### **8.4 Combined Design Phase**

The UI PM and the DP may elect to combine the Schematic Design Phase and Design Development Phase into a single Design Phase on small projects, projects of limited scope, or in cases where it makes sense to have a single design phase followed directly by Construction Documents. In these cases, the UI PM and DP shall set the expectations for progress meetings and Design Phase deliverables and these shall be outlined in the Scope of Work document submitted by the DP.

## **CHAPTER 9 - CONSTRUCTION DOCUMENTS**

### **9.1 Meetings**

The Design Professional shall schedule construction document review meetings with the UI PM at intervals appropriate to the project scope. These may include update meetings with the UI Stakeholder Group as well as review meetings with various UI departments to ensure that the design meets equipment, maintenance and safety standards; to include (where applicable): Building Trades (Electrical / HVAC / Plumbing / Refrigeration), Landscape & Irrigation, Utilities & Engineering, Steam Plant, Parking & Transportation Services, Environmental Health & Safety, and Campus Safety & Security.

The DP shall coordinate with the UI PM to gather all Owner required items for LEED credits (where applicable).

The DP will be expected to run the meetings, take thorough notes and distribute minutes of the meetings.

### **9.2 Construction Document Approval**

The Design Professional and consultants shall conduct a thorough review of the construction documents to ensure that: all previous comments have been incorporated, the documents are 100% complete, the documents have been fully coordinated between disciplines and are ready for final Owner review and approval.

The construction documents must be accompanied by a detailed construction cost estimate including a list of approved bid alternates.

The UI PM will coordinate the UI insurance carrier advisory review of the construction document package, as applicable, through the UI Risk Management office as outlined in Chapter 2, paragraph 2.6 of these Design Guidelines.

The UI PM will provide the Design Professional with the Authorization to Proceed into the Bid Phase when all corrections and approvals have been achieved.

### **9.3 Bid Alternates**

Bid Alternates must be approved by the UI PM. Typically, one (1) to three (3) bid alternates are acceptable, although more may be required in special cases or larger projects. Large numbers of alternates should be avoided. Alternates should be used strategically to help manage bid day costs against the Owner's maximum allowable construction cost.

Bid Alternates should generally be listed in order of preference. However, the UI retains the right to select or decline Bid Alternates in any order that best serves the project.

### **9.4 Unit Prices**

Unit prices will only be utilized with approval of the UI PM. If used, they are typically for adjusting predetermined quantities of material and not for doing additional work.

### **9.5 DBS Plan Review and Fees**

The Design Professional shall be familiar with the policies and procedures related to submitting plans to the Division of Building Safety for plan review. The DP will be expected to fill out the plan review application and submit final documents to the Division of Building Safety through the DBS ProjectDox system. The UI will arrange for payment of plan review fees through the interagency billing system.

The Design Professional shall respond to DBS comments and modify the construction documents as required. The final documents published for bidding shall have the DBS approval stamp in the upper corner.

### **9.6 Project Manual Format**

#### **9.6.1 UI Frontals and Boilerplate**

The standard University of Idaho Cover, Title Page, Contents, and Bidding / Contract Boilerplate documents will be provided by the UI PM and/or are available for download at:

<https://www.uidaho.edu/dfa/budget-and-planning/aes/forms>

The DP shall verify that they are using the most up-to-date set of Boilerplate documents before each project.

The DP shall insert the boilerplate in the exact order as provided. The DP shall not alter the formatting of the documents, except as outlined in document "0-0 Boilerplate Instructions and Checklist". The DP shall make all required revisions to the Boilerplate as outlined in "0-0 Boilerplate Instructions and Checklist".

The UI standard Boilerplate shall be used on all design-bid-build projects unless otherwise directed by the UI PM. On projects less than \$200,000, the UI PM may elect to implement an informal / abbreviated bid process. In that case, the specification frontals may be reduced to the following:

- Cover

- Title Page
- Contents
- Notice to Contractors
- Abbreviated Bid Proposal (to be provided to the DP by the UI PM)
- Contractor's Affidavit Concerning Alcohol and Drug-Free Workplace
- (Technical Specifications to follow as required)

**9.6.2 Technical Specifications**

The Design Professional may prepare the technical specifications using any standard "CSI MasterSpec" format per the DP's office standards. The DP may format the appearance of the technical specifications as per the DP's office standards, including font type, header content, footer content, etc ...

**9.6.3 Division I - General Requirements**

The Design Professional shall prepare General Requirements to specifically address project issues. The DP shall review the Division 1 requirements outlined in the "Section 3 – Technical Standards" portion of these guidelines, and make sure that those requirements are incorporated into the DP's Division 1 – General Requirements specifications.

**9.7 UI Drawing Conventions**

**9.7.1 Cover Sheet**

Cover sheet should include:

- Project Title,
- Building Name and UI Building ID Number (if applicable),
- UI Capital Project Number.

Provide space in upper left-hand corner for DBS approval stamp.

**9.7.2 Architect or Engineers Stamp**

A State of Idaho professional stamp with signature, and date of responsible DP or sub-consultant shall be included on every title block in the final bid sets.

**9.7.3 Use of UI Logos or Branding**

Use of University of Idaho wordmarks and/or logos (past or present) is not allowed on the drawings or specifications unless the DP receives prior approval from the UI PM and the UI Marketing & Communications department. If approval is given, the DP shall review the requirements and stipulations of use at the UI Brand Resource Center.

Use of licensed University of Idaho Athletics word marks or logos (past or present) is not allowed on the drawings or specifications unless otherwise authorized.

**9.7.4 Room Numbering on Floor Plans**

On all new building projects and/or major remodels that make significant changes to the existing floor plans, all new room numbering shall conform to the following table:

	General Room Numbers	Elevators	Circulation Spaces	Mechanical Rooms	Stairs
Basement	001 - 099	ELB1 - ELB9	HL01 - HL09	ME01 - ME09	STB1 - STB9
First Floor	100 - 199	EL11 - EL19	HL11 - HL19	ME11 - ME19	ST11 - ST19
Second Floor	200 - 299	EL21 - EL29	HL21 - HL29	ME21 - ME29	ST21 - ST29
Third Floor	300 - 399	EL31 - EL39	HL31 - HL39	ME31 - ME39	ST31 - ST39

Additional Room Numbering Notes:

1. All numbers should be 3-4 characters (if possible).

2. Where it makes sense to do so, small suites may be numbered by adding a letter to the end of the room number. For example, suite 300 may consist of rooms 300A, 300B, 300C, and 300D. This should only be used in limited areas and only at the approval of the UI PM and UI Space Planner
3. Circulation numbers are only used for spaces that are classified as "Non-assignable" based on the "Postsecondary Education Facilities Inventory and Classification Manual" published by the National Center for Education Statistics.
4. Typical numbering is counter-clockwise with even numbers on the LEFT side of the corridor and odd numbers on the RIGHT (if possible).
5. The most important consideration in the room numbering strategy is wayfinding. The DP shall consider wayfinding and how people will be intuitively directed through the building.
6. Steam Tunnels are considered Mechanical Rooms.

The Design Professional shall submit room numbering plans to the UI PM and UI Space Planner for review and approval during the Design Development Phase.

### **9.7.5 HVAC Equipment Labeling**

Refer to Section II – Construction and Technical Standards, "Division 23 – HVAC" for UI standards for labeling Air Handler Units and distribution VAV boxes on the mechanical drawings.

## **CHAPTER 10 – BIDDING, PRINTING and PERMITS**

The discussion in this section pertains to standard public bidding of design-bid-build University projects. Other options include: Selection of a Construction Manager / General Contractor, Informal / Abbreviated Bidding for projects under \$200,000, construction by UI Building Trades staff, and sole source bid quotes on projects less than \$50,000. The UI PM will determine the appropriate method and obtain approval as applicable.

### **10.1 Bid Date, Time and Location**

When the Construction Documents are ready for bidding, the UI PM will work with the Design Professional to establish a bid date and time.

The bid period shall be a duration of time as appropriate for the size of project and scope of work. Most projects will have a bid period duration of three (3) to four (4) weeks. Smaller projects might have a bid period duration as short as two (2) weeks.

Bid time and date is typically set at 2:00 pm on a Tuesday or Thursday unless otherwise authorized by the UI PM.

Bids for projects on the main campus in Moscow, Idaho will be opened at the offices of Architectural and Engineering Services. If the project is located at one of the UI extension campuses or research sites, the UI PM may elect to hold a bid opening locally at a place and time to be determined.

### **10.2 Advertisements**

The Design Professional and UI PM shall work together to edit the bid advertisement. The Ad-for-Bid must be processed internally at the UI and signed by the UI Vice President, Finance and Administration.

Arrangements and payments for advertisements will be made by the Owner.

### **10.3 Bid Document Distribution**

The Design Professional shall issue bid documents to all plan centers on the UI Regional Plan Center list, issue bid documents to prospective prime bidders, maintain an accurate plan-holders list, and receive and refund bid document deposits where applicable. The DP may implement the use of an on-line plan service or printing center for the distribution of electronic and printed plans. The DP shall make the bid documents available



electronically, via the internet, e-mail, or other hosting service.

The UI PM will approve reimbursement of printing and distribution costs.

Bid documents, either partial or full sets, may be distributed to other interested parties, as well as additional sets to prime bidders at cost, non-refundable.

The DP will send one full size set of printed plans and specifications, and one half-size set of printed plans and specifications, to the UI PM. Additional sets may be requested by the UI PM.

#### **10.4 Bid Period Questions and Addenda**

The Design Professional is expected to answer bidders' questions, review/approve substitution requests, and issue addenda to all plan-holders. All addenda require UI PM review and approval prior to issuing.

All addenda shall be issued under the Design Professional's name or letterhead and contain the date issued. The DP shall issue Addenda to the entire plan holders list including regional plan centers. The UI PM will coordinate posting of Addenda to the UI website if required. The last addendum should be issued to bidders at least four (4) calendar days prior to bid opening, the exception being an addendum to delay or cancel the bid.

#### **10.5 Pre-Bid Conference**

A pre-bid conference will typically be held for prospective bidders. Pre-bid conferences shall not be made mandatory for bidders unless otherwise directed by the UI

The DP shall be expected to run the Pre-Bid Conference and will have an agenda and attendance sign-in sheet ready for the meeting. The DP shall take thorough notes of all items discussed or observed and prepare minutes for the Pre-Bid. The minutes shall be included in an addendum. (An example of a UI Pre-Bid Conference agenda is included in Appendix B of these guidelines.)

#### **10.6 Bid Opening Procedures**

The bid opening shall be conducted by either the Design Professional or the UI PM. Attendance by the DP is required unless otherwise discussed with the UI PM.

The bid opening is public information, therefore submitting contractors and other interested parties are welcome to witness the bid opening. The UI PM will invite members of the UI Stakeholder Group as appropriate. Sealed bids will be opened and read aloud by the DP or UI PM.

The UI CCS, unless otherwise coordinated with the DP, will complete a standard bid tabulation summary which lists those bidders who submitted their bid prior to the bid deadline, a checklist of required bid items, public works contractor's license, base bid amounts, bid alternate amounts, and names of primary HVAC, plumbing, electrical and fire sprinkler sub-contractors.

#### **10.7 Disclosing Bid Results**

As soon as possible after the bid opening, the UI CCS will electronically transmit the bid results to the Design Professional and the regional plan centers. The bid results will be posted to the UI website.

The Design Professional shall provide the results of bidding to those inquiring and state that "all bids are taken under advisement" until the contract award is made. The Design Professional is to give no indication of the potentially successful bidder without UI approval/confirmation. The Design Professional shall not initiate any contact with the bidders unless directed by the UI PM.

#### **10.8 Formal Acceptance of the Bid**

The UI PM, the UI CM, the DP, and representatives of the UI Stakeholder Group will make a preliminary determination of the acceptance or rejection of the base bid and any alternates. If any low bid is identified as

non-conforming, the bid material shall be reviewed by the UI CCS and UI CM, who will issue formal bid rejection letters if applicable.

### **10.9 Construction Contract and Notice of Intent to Award**

The UI CCS will prepare the Owner-Contractor Agreement and issue a Notice of Intent to Award to the accepted, low bid Contractor. When all signatures, contractor's licenses, bonds, subcontractor listing, and insurance documentation have been received, reviewed and are found to be in order, the UI CCS will coordinate final approval and signature of the Agreement by the UI Vice President, Finance and Administration.

### **10.10 Permits and Fees**

The Contractor shall, without additional expense to the UI, be responsible for obtaining all necessary licenses and permits, the costs for which are to be made a part of the base bid.

All University of Idaho construction projects are required to have a building permit issued by the Division of Building Safety. It is the contractor's responsibility to obtain this permit and include that cost in the base bid work. This requirement shall be noted by the DP in the project manual and reiterated in the Pre-Bid Conference.

### **10.11 LEED Design Phase Submittal**

The Design Professional shall be prepared to submit the LEED Design Phase Submittal (where applicable) at the successful conclusion of the bidding phase.

## **CHAPTER 11 - CONSTRUCTION ADMINISTRATION**

### **11.1 Pre-Construction Conference**

#### **11.1.1 Scheduling the Conference**

The DP, in coordination with the UI PM, is responsible for scheduling the pre-construction conference with the Contractor. The pre-construction conference should occur after the contracts are signed and the UI is ready to issue the written Notice to Proceed (NTP).

#### **11.1.2 Participants**

Those attending will include the Design Professional and major sub-consultants, UI PM, UI CM, UI CI, representatives from the UI Stakeholder Group, Contractor and major sub-contractors. The UI PM will also coordinate the inclusion of UI Parking and Transportation Services and other campus entities as required.

#### **11.1.3 Meeting Chair and Agenda**

The DP will chair the pre-construction conference and have a detailed agenda ready for the meeting. A sample Pre-Construction Meeting Agenda is included in "Appendix A" of these guidelines, or may be downloaded at: <https://www.uidaho.edu/infrastructure/facilities/info-requests/forms>

The Design Professional will record and distribute the minutes of the meeting.

### **11.2 Construction Progress Meetings**

The general schedule for construction progress meetings shall be established at the pre-construction conference. Meetings are typically scheduled a minimum of once per month unless the scope and schedule of the project requires progress meetings at more frequent intervals.

These regular meetings should be attended by the DP, the DP's consultants when applicable, the UI PM, the UI CM / CI, contractor, major sub-contractors, and specialty sub-contractors including major suppliers when

applicable. The DP shall maintain a status list of all project SI's, RFI's, PR's, CCD's, Change Orders, and Shop Drawings to be reviewed at each meeting.

The Design Professional will chair the meetings, record and distribute the minutes.

### **11.3 Contractor Inquiries**

Any questions raised by the contractor shall be documented by the Design Professional. The Design Professional shall expeditiously provide written answers to contractor questions or requests for information (RFI). Each question or request should be assigned a number and tracked.

Any impact to construction cost or schedule must be noted. All changes to the construction contract should be initiated through a Proposal Request (PR) or Construction Change Directive (CCD) and must be finalized in a Change Order (CO).

### **11.4 Change Orders**

Change Orders document the modifications to an existing contract. The change order procedure can be initiated by the Owner, Contractor, or the Design Professional. The Design Professional will generally start the process using a Proposal Request form.

### **11.5 Proposal Request (PR)**

Proposal Requests are issued to the contractor by the Design Professional. The contractor shall provide the required cost information including labor, material, equipment, subcontract and allowable overhead and profit breakdown, and any extension of the contract duration.

The Design Professional shall review the Contractor's change order proposals for compliance with the General Conditions, and to ensure that the costs and time requested are reasonable in comparison to industry standards.

The response must be accepted by the UI PM prior to its conversion into a Change Order (CO).

### **11.6 Construction Change Directive (CCD)**

If immediate approval to proceed with a change in the work is necessary, a CCD may be used to authorize work to maintain the project schedule, to protect property, or for health / safety reasons. A CCD should only be used when Proposal Request and Change Order preparation and execution cannot be done prior to the event imposing on the project schedule and/or cost.

In an emergency, the Design Professional, UI PM or UI CM can obtain verbal authorization to proceed with CCD work. The Contractor, Design Professional, UI PM and UI CM must all be in agreement to authorize work by CCD.

A CCD may be authorized to commence the work for a maximum not-to-exceed amount. After the work is completed, the Contractor must produce itemized cost and labor data in compliance with the terms of the Agreement. This cost data must be reviewed and approved by the Design Professional and UI PM prior to conversion of a CCD into a CO.

### **11.7 Construction Observation**

The Design Professional, in consultation with the UI PM and UI CM, shall establish a mutually satisfactory schedule for site visits in accordance with the Agreement. The Design Professional shall prepare and distribute written reports of all site visits.

Any construction observed by the Design Professional to be out of conformance with the contract documents shall be documented. The report of non-compliance shall be transmitted to the Contractor, with information copies to the UI PM, UI CM, and UI CI.

If the UI PM, UI CM or UI CI observes construction which appears to be out of conformance, the observation shall be reported to the Design Professional. Only the Design Professional shall direct the Contractor in matters involving interpretation of the drawings or technical specifications.

The DP shall periodically review Contractor progress in adhering to specifications, documentation and reporting requirements related to LEED.

Any questions or Requests for Information (RFI's) submitted by the Contractor shall be documented by the Design Professional. The DP shall expeditiously provide written answers to the Contractor with copies to the UI PM, UI CM and/or UI CI.

### **11.8 Submittals and Shop Drawings**

The Design Professional is required to communicate clearly to the contractor, at the pre-construction conference or shortly thereafter, all the required submittals, i.e., schedule of values, list of subcontractors, progress schedule, materials, equipment, shop drawings, operation and maintenance manuals, and any other submittals required for the project. The DP shall inform the Contractor and UI PM if submittals are not being provided as required.

The Design Professional shall check the Contractor's shop drawings, material and equipment submittals for compliance with the contract documents. Substitutions approved by the Design Professional must also be approved by the UI PM when appearance, performance, maintenance or operation is impacted. The DP shall distribute shop drawings to the UI PM for conformance review at the same time the DP is reviewing shop drawings. Any UI comments will be sent to the DP and incorporated in the DP's submittal review comments.

### **11.9 Processing Contractor's Payment Requests**

The Contractor shall send all payment applications to the DP for review. If the Contractor's payment request is incorrect, the payment request shall be sent back to the Contractor along with written directions identifying the needed corrections. No payment request shall remain in the possession of the Design Professional longer than seven days.

The Design Professional shall check the percentage of completion on all line items in the schedule of values, verify the pay period dates are accurate, that the total amount due on the payment request reflects construction progress to date, and that the amount remaining on the contract is adequate to complete the work. The Design Professional shall confirm that the amounts requested are correct, and then forward to the UI PM and UI CCS with a recommendation to proceed with processing and payment.

## **CHAPTER 12 - PROJECT CLOSE-OUT**

### **12.1 Project Completion and Acceptance**

The Design Professional shall schedule the substantial completion inspection with the Contractor, UI PM and UI CI. The DP shall prepare and issue the "punch list" to the Contractor and monitor the Contractor's performance to ensure the work on the list is completed. Comments and punch list items generated by any UI representatives should be evaluated by the DP for inclusion in the final "punch list".

The Design Professional shall take the lead role in monitoring the project completion and close-out process. The DP shall diligently encourage the Contractor to complete the work in accordance with the contract documents and within the contract time for completion.

### **12.2 O&M Manuals**

The Design Professional shall review O&M Manuals for compliance with the contract documents. Information

provided shall be specific to the equipment and systems installed in the project and should include all major shop drawings and warranties. A finish legend should be provided with the O&M Manual identifying products and manufacturer color selections.

### **12.3 Extra Stock**

The DP shall develop a log sheet or form that lists all extra stock, overage and/or spare parts required by individuation technical specifications. The form shall list all extra stock items and provide spaces to document “date delivered” and signatures of the Owner and Contractor representatives. The UI CI and/or UI PM will monitor the delivery of extra stock and fill out the log sheet. Final project acceptance won’t be granted until all extra stock is delivered.

### **12.4 Owner Training**

The Design Professional shall review the Contractor’s training plan and training material to ensure compliance with the contract documents. The DP shall make sure Owner Training is scheduled through the UI CM or CI. Where necessary, the documents shall require the Contractor to provide video of the training sessions.

On large or complex projects, it may be beneficial to specify extended training sessions that require the Contractor to present follow-up training six months after occupancy.

### **12.5 Testing and Balancing**

When Testing and Balancing is required by projects, the DP or DP’s sub-consultants shall oversee the testing and balancing process and spot check results to ensure accuracy. Provide for re-balancing if spot checks identify discrepancies. Assure that systems such as elevators, electrical, fire alarm, fire sprinkler, telephone and data cabling are properly tested and conform to project requirements.

### **12.6 Commissioning**

When Commissioning is included on a project, the DP shall assist the Commissioning Authority by providing information on design and obtaining needed information from the Contractor.

### **12.7 Substantial Completion**

The DP and UI PM shall determine the date of Substantial Completion. That date establishes the completion of the contract for purposes of liquidated damages and begins the one-year contractor warranty period.

“Substantial Completion” shall mean that point at which the building or impacted remodel area can be occupied, used and operated for its intended purpose. Incidental corrective or “punch list” work may still need to be completed.

The following are prerequisites to establishing Substantial Completion:

- Completion of all contracted work except incidental punch list items,
- Permits and approvals such as electrical, plumbing, elevators and fire systems are received,
- Testing and Balancing of building systems is complete,
- Building Commissioning is substantially complete,
- Owner Training has been completed,
- The DBS building inspector is ready to issue the Certificate of Occupancy or Completion.

The time between Substantial Completion and the completion of all remaining corrective or “punchlist” items should be no more than thirty (30) calendar days, unless authorized by the UI PM and/or UI CM.

### **12.8 Final Completion and Acceptance**

The Design Professional shall manage the final completion process to ensure that the University receives a building that can be operated and maintained in the manner envisioned in the design. Final Completion means that the work is fully and finally completed in accordance with the contract documents and that all other contract requirements have been met. The following are prerequisites to establishing final completion:

- Any claims resolved, all CCD and PR items completed and Change Orders processed,
- Completion of all Punch List work,

- Submittal of completed and accepted “as-built” documents from the Contractor.
- Submittal and approval of O&M Manuals,
- Adjustments for liquidated damages,
- Retention identified for any extended or delayed training,
- Building Commissioning completed (when applicable),
- All final releases and documentation have been submitted and approved,
- Tax Release has been issued to the Contractor by the Idaho State Tax Commission.
- All extra stock and spare parts have been delivered to the Owner.
- All keys have been returned, and Key Request paperwork is completed.

The completion of the following closeout documents must be coordinated by the Design Professional and submitted to the Owner (Refer also to Division 0 Contract Requirements and Boilerplate):

- Certificate of Substantial Completion
- Consent of Surety to Final Payment
- Contractor’s Affidavit of Payment of Debts & Claims
- Contractor’s Affidavit of Release of Liens

When the above conditions have been met, the Owner shall approve final acceptance and payment.

## **12.9 Design Professional Final Deliverables**

At the end of the project, unless otherwise directed by the UI PM, the DP shall provide to the Owner the following final deliverables:

### **12.9.1 As-Built Drawings and Specifications**

The DP shall provide to the UI one physical copy and one electronic pdf copy of the plans and specifications, with all as-built conditions and document changes edited into the plans or otherwise annotated on the documents. The title block on the plan drawings should be clearly marked as “As-Built” and shall include the revised printing / issue date. These as-built drawings and specifications will be placed in the University’s physical and electronic archive.

### **12.9.2 CAD / Revit Files**

The DP shall provide an electronic copy of the floor plans in AutoCAD format. The floor plans may be “cleaned” at the DP’s discretion to protect intellectual property. The plan backgrounds will be used to update the University’s “Building Reference Plans”.

### **12.9.3 Document Binder**

Unless otherwise directed by the UI PM, The DP shall provide a binder (one copy) containing all project Addenda, Supplemental Instructions, RFI’s, Proposal Requests, CCD’s, and Change Orders.

### **12.9.4 LEED Construction Submittal and Final Report (When applicable)**

The Design Professional shall coordinate and submit the final LEED Construction Submittal, review and answer any USGBC comments, and prepare documentation related to a final report and certification level.

## **12.10 Warranty Period**

The warranty period generally begins on the date of Substantial Completion and extends for a period of one full year. Warranty periods for individual building systems, products or equipment may be longer.

Should any warranty issues arise during the Warranty Period, the UI PM will submit a Warranty Deficiency Report directly to the Contractor, with copies to the DP.

The Design Professional and/or UI PM shall schedule a walk-through prior to expiration of the warranty period. The walk-through should be attended by the DP, Contractor, UI PM, UI CI, and any UI Stakeholder representatives as applicable. All deficiencies and highlights should be noted in the minutes by the Design Professional.

The University may, at its discretion, survey the building occupants and conduct an in-house inspection to

determine if a full Warranty inspection is required.

Under either option, the Contractor will correct all viable deficiencies identified.

## **CHAPTER 13 - PUBLIC WORKS CONTRACTOR REQUIREMENTS**

### **13.1 Authority**

Idaho Statutes: Title 54. Professions, Vocations, and Businesses; Chapter 19. Public Works Contractors

Note: The following Idaho Code Title 54, Chapter 19 citations are paraphrased and/or shortened from the official statutes for the purposes of highlighting critical information for prospective contractors. The listed citations below are only a small part of the overall content of Title 54, Chapter 19. Contractors shall review the full content at:

<https://legislature.idaho.gov/statutesrules/idstat/Title54/T54CH19/>

### **13.2 Definitions (IC 54-1901)**

"Public Works Contractor," is any person who, in any capacity, undertakes, or offers to undertake, or purports to have the capacity to undertake any construction, repair or reconstruction of any public work, or submits a proposal to, or enters into a contract with, the state of Idaho, or any department or agency thereof.

"Public Works construction" includes any or all of the following branches: Heavy construction, Highway construction, Building construction, and Specialty construction.

### **13.3 Unlawful to engage in public works contracting without license (IC 54-1902)**

It shall be unlawful for any person to engage in the business or act in the capacity of a public works contractor within this state without first obtaining and having a license. (IC 54-1902.1)

It shall be unlawful for any public works contractor to subcontract in excess of eighty percent (80%) of the work under any contract to be performed by him as such public works contractor according to the contract prices therein set forth, unless otherwise provided in the specifications of such contracts. (IC 54-1902.2)

Except as provided in subsection 54-1902(4), it shall be unlawful for any public works contractor to:

Accept a bid from any person who at that time does not possess the appropriate license for the project involved. (IC 54-1902.3.a)

Accept bids to sublet any part of any contract for specialty construction from a specialty contractor who at that time does not possess the appropriate license in accordance with this chapter. (IC 54-1902.3.b)

### **13.4 Exemptions**

Duly licensed architects, licensed engineers, and land surveyors when acting solely in their professional capacity. (IC 54-1903(8))

Any construction, alteration, improvement or repair involving any single project involving any number of trades or crafts with an estimated total cost of less than fifty thousand dollars (\$50,000). (IC 54-1903(9))

No contractor shall be required to have a license to submit a bid or proposal for contracts for public works financed in whole or in part by federal aid funds, provided that, **at or prior to the award and execution of any such contract, the successful bidder has secured a license** as provided in this chapter. (IC54-1902(4))

### **13.5 Classes of Licenses (IC 54-1904)**

- Class "Unlimited": Maximum Contract Limit: No Limit
- Class "AAA": Maximum Contract Limit: \$5,000,000
- Class "AA": Maximum Contract Limit: \$3,000,000
- Class "A": Maximum Contract Limit: \$1,250,000
- Class "B": Maximum Contract Limit: \$600,000
- Class "CC": Maximum Contract Limit: \$400,000
- Class "C": Maximum Contract Limit: \$200,000
- Class "D": Maximum Contract Limit: \$50,000

The total of any single bid on a given public works project, or the aggregate total of any split bids, or the aggregate of any base bid and any alternate bid items, or the aggregate total of any separate bid by a licensee of any class, except Class "Unlimited," shall not exceed the estimated cost or bid limit of the class of license held by the licensee. The aggregate total of bids shall include all bids of subcontractors. (IC 54-1904.6)

### **13.6 Filing of Notices and Income Tax Returns (IC 54-1904A)**

Within thirty (30) days after any public works contractor who is required to be licensed pursuant to this chapter has been awarded a contract for construction to be performed within the state of Idaho involving the expenditure of any public moneys, the contract awarding agency shall notify the state tax commission that the contract has been awarded and shall provide to the state tax commission the name and address of the prime contractor. Upon written request of the state tax commission, the prime contractor, within thirty (30) days, shall file with the state tax commission a signed statement showing the date on which such contract was made or awarded, the names and addresses of the home offices of the contracting parties, including all subcontractors, the state of incorporation if the party is a corporation, the project number and a general description of the type and location of the work to be performed, the amount of the prime contract and all subcontracts, and all other relevant information which may be required on forms which may be prescribed by the state tax commission. The state tax commission shall forward to the administrator such information from the form as the administrator and the state tax commission agree is necessary for the administrator to fulfill the requirements of section 54-1913, Idaho Code. Every contractor or subcontractor whose name appears on any such notice shall be required to file income tax returns with the state tax commission and to pay all income taxes which may be due thereon pursuant to law for all years in which any public moneys were received by him in connection with any construction work which was performed within the state of Idaho.

### **13.7 Performance and Payment Bonds (IC 54-1926)**

Before any contract equal to or greater than fifty thousand dollars (\$50,000) for the construction, alteration, or repair of any public building or public work or improvement of the state of Idaho, or agency thereof, is executed, the person to whom such contract was awarded shall furnish to the state of Idaho, or agency thereof, bonds that shall become binding upon the execution of the contract.

A performance bond in any amount to be fixed by the contracting body, but in no event less than eighty-five percent (85%) of the contract amount conditioned upon the faithful performance of the contract in accordance with the plans, specifications and conditions thereof. Said bond shall be solely for the protection of the public body executing the contract.

A payment bond in an amount to be fixed by the contracting body but in no event less than eighty-five percent (85%) of the contract amount, solely for the protection of persons supplying labor or materials, or renting, leasing, or otherwise supplying equipment to the contractor or his subcontractors in the prosecution of the work provided for in such contract.



# SECTION II CONSTRUCTION and TECHNICAL STANDARDS

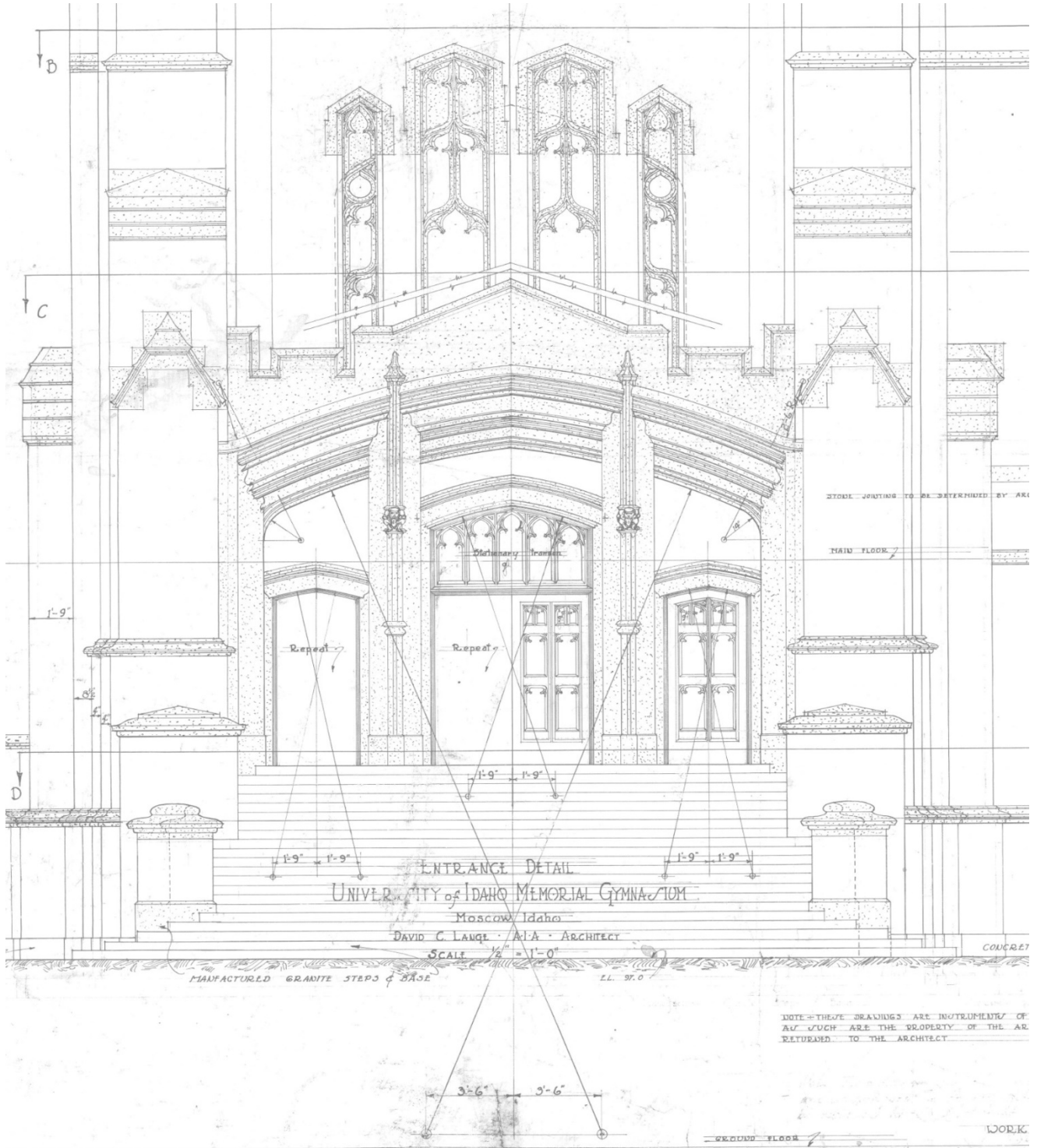

## SECTION II CONTENTS

### SECTION II – CONSTRUCTION AND TECHNICAL STANDARDS

00	Scope and Intent
Division 01	General Requirements
Division 02	Existing Conditions
Division 03	Concrete
Division 04	Masonry
Division 05	Metals
Division 06	Wood, Plastics, and Composites
Division 07	Thermal and Moisture Protection
Division 08	Openings
Division 09	Finishes
Division 10	Specialties
Division 11	Equipment
Division 12	Furnishings
Division 13	Special Construction
Division 14	Conveying Equipment
Division 21	Fire Suppression
Division 22	Plumbing
Division 23	Heating, Ventilating, and Air Conditioning (HVAC)
Division 26	Electrical
Division 27	Communications (e.g., data, voice, audio/visual systems)
Division 28	Electronic Safety and Security
Division 31	Earthwork
Division 32	Exterior Improvements
Division 33	Utilities

## **Construction and Technical Standards SCOPE and INTENT**

These standards represent the preferred construction products, materials, details and systems to be used by Design Professionals in the development of programs, plans, specifications and construction documents for all projects on property owned by the Board of Regents, University of Idaho. The standards are the result of years of experience in designing, building and operating facilities for the University of Idaho and include a historical knowledge of what products and methods have best served the University.

Components listed in these standards are selected through pre-qualification guidelines including, but not limited to, performance characteristics, code/regulatory compliance, safety concerns, maintenance control and inventory standardization. These standards represent the intent of the University of Idaho to address the following primary criteria:

- Safety
- Reliability
- Maintainability
- Efficiency
- Sustainability

These guidelines are to serve Design Professionals in the preparation of all necessary documents and specifications required to deliver a complete project. Design Professionals are advised to refer to those sections of the Construction and Technical Standards that apply to each project and review all the information therein. Design Professionals shall integrate the use of all standards, products and methods into the construction documents and specifications as coordinated with the UI Project Manager

The Construction and Technical Standards are organized in a manner that approximately corresponds with the industry standard "Construction Specification Institute (CSI) MasterFormat; 2016 Version". This format is for convenience and organizational clarity and does not implicate that the DP's specifications must be organized using the same CSI MasterFormat version. Design Professionals may use earlier versions of the CSI MasterFormat at their discretion, to include the pre-2004 16-Division formats.

It should be clearly understood by all persons using these standards that they are not specifications documents. Design and document preparation continue to be the Design Professional's responsibility. Construction means, methods, techniques and procedures remain the Contractor's responsibility.

The requirements of these guidelines and standards are not intended to supersede any adopted or applicable building codes, ordinances, statutes, regulations or laws. If there is a conflict with any requirement in the Construction and Technical Standards, the applicable code or law takes precedence.

# DIVISION 01 - GENERAL REQUIREMENTS

## **01 10 00 Summary**

### **Work by Owner**

The Owner (UI) reserves the right to award other contracts related to the project, or to self-perform certain work related to the project. Any such work may or may not be known to the Owner or disclosed to the contractor prior to execution of the Agreement. The Contractor shall afford the Owner and such other contractors reasonable opportunity for the access to the jobsite, storage of materials and equipment and the ability to execute the Owner's work.

The changing needs and requirements of a dynamic campus require flexible contract administration capabilities. Consequently, the University of Idaho is a hands-on owner during all construction projects. Adjustments are inevitable and scope changes should be expected. Immediate coordination access to the contractor is vital. To form the necessary contract administration partnership with the contractor, the specifications for all projects shall include the following.

## **01 14 00 Work Restrictions**

### **Hours of Operation**

City of Moscow noise ordinance allows work between 7:00 AM and 9:00 PM. University requirements may be more restrictive on a project by project basis.

### **Street Closures**

Any work which closes or impacts the flow of traffic on any street shall conform to all City of Moscow and Department of Transportation (DOT) requirements. This includes, but is not limited to prior City approval, use of Class "A" Barriers, signage and other traffic control devices, and the use of flag-persons with hard hats and high visibility apparel. Signage and traffic control must follow the Manual for Uniform Traffic Control, current edition. The City will need a complete plan submitted from a traffic control company for review.

### **Lifting and Hoisting**

The contractor shall review all lifting and hoisting plans with the UI CM prior to bringing any cranes or hoisting equipment on campus. The contractor shall provide evidence ensuring that employees and/or operators have received required training and are certified and licensed to operate applicable cranes, hoists and equipment. In certain cases, the UI may require the submittal of an engineered hoisting plan outlining equipment lift capabilities / restrictions specific to the work.

The contractor shall provide a schedule for any hoisting operations and a safety plan for barricading the site during lifting operations. Any lifting over occupied spaces is strictly prohibited. A crane / lifting plan for occupied spaces shall be coordinated with the UI CM and UI PM far enough in advance to allow adequate time to vacate spaces as necessary.

### **Building Access**

Building access is strictly controlled on campus by the UI Facilities Director of Trades and the UI Key Shop. Exterior access to UI buildings will be achieved, when possible, using the UI Vandal Card Access system. Contractors and Design Professionals may be required to obtain a UI Vandal Card from the UI Vandal Card Office while working under an official UI contract or project. If the work can be performed during normal business hours, then this requirement may be waived by the UI PM or UI CM.

If after-hours or weekend work is deemed necessary by the UI PM, advanced notice should be given to the UI Key Shop. If the contractor or consultant has been issued a UI Vandal Card in advance of the work, then access rights can be set up through the network and can be granted more quickly ... within the hour in many instances.

Room by room interior keyed access is strictly controlled on campus by the UI Facilities Director of Building Trades and the UI Key Shop.

### **Building Keys**

Key requests require the contractor or consultant to fill out a UI Key Request Form. Lines 1 through 3 shall be filled out by an authorized agent of the Contractor or Design Professional making the request. No UI keys can be issued to an individual or firm that does not have a current contract agreement directly with the University of Idaho or the Division of Public Works.

Building keys will not be issued to subcontractors on any UI or DPW projects. Subcontractors will be required to obtain key access via the General Contractor holding a contract or agreement associated with the project. The GC will be responsible for monitoring distribution and use of keys to subcontractors.

Any Key(s) issued to an individual or firm must be returned with the required accompanying paperwork, signed by an authorized UI Agent and marked "all keys returned". This paperwork is required as a part of the project close-out documents and retained dollars or final pay applications will not be processed by the UI or DPW until the return paperwork is completed. Partial sets of returned keys will not prompt a release of retained dollars. Retainage will only be released after all keys are returned.

Keys not returned, or keys returned without completing the proper paperwork, will be considered lost and will initiate the process of re-keying the impacted area(s). The University's cost for re-keying work will be deducted from the Contractor's final pay application or retainage, or both.

At the request of the Contractor, the UI PM may hold the final pay application for thirty (30) days while the Contractor attempts to locate any missing keys. If, after thirty (30) days, the Contractor is unable to produce all the keys listed in the Key Request paperwork, the UI PM shall initiate the re-keying process and deduct the costs associated with that re-keying effort from the final payment application or retainage, or both.

### **Contractor Conduct on Campus**

All general contractors working on University of Idaho property, including all associated subcontractors, laborers, staff and vendors under the Contractor's supervision, shall comport themselves in a professional and courteous manner at all times. The UI has a zero-tolerance policy regarding abusive behavior or interactions with students, faculty and staff. The university strives to promote a safe, diverse and respectful learning environment. Any incidents of abusive, suggestive, racial, and/or discriminatory comments, behaviors or interactions are grounds for immediate and permanent removal of individuals from the jobsite and campus.

The same policy extends to any vehicles belonging to the Contractor as well as all associated subcontractors, laborers, staff and vendors under the Contractor's supervision. The university requires that lewd or suggestive icons, logos, banner, placards, or images be removed or sufficiently covered while the vehicle is on campus.

If the Contractor, or any associated subcontractors, laborers, staff and vendors under the Contractor's supervision, find themselves in a situation where unauthorized UI staff or students are asking for work stoppages, attempting to give direction or instruction, or otherwise acting in a rude or harassing manner, then the Contractor and/or his workers shall be expected to keep their composure, remain courteous, and call the UI CM, UI CI, or UI PM immediately to help diffuse the situation.

If any unauthorized UI staff or students are trespassing on, or trying to shortcut through, the Contractor's construction fencing or safety barriers, the Contractor, or any associated subcontractors, laborers, staff and

vendors under the Contractor's supervision, shall; 1) make sure that the individual is not in immediate danger by whatever means necessary; 2) remain calm and explain to the individual why they can't be in that area, and; 3) escort the individual out of the construction zone. If the Contractor experiences any trouble with repeat offenders, or experiences rude or aggressive behavior, then the Contractor shall maintain composure and call the UI CM, UI CI, or UI PM to help intervene on behalf of the contractor. Repeat offenders or problem individuals will be reported to Campus Security.

### **Use of Tobacco Products**

Smoking and other use of tobacco products is prohibited on campus for all students, staff, and visitors. This includes contractor job sites on campus property.

### **Use of Radios / Music**

The use of radios and/or other music playback devices (without headphones) are prohibited unless otherwise approved by the UI CM or UI CI.

### **Use of University Dumpsters**

Use of UI dumpsters, recycling bins, or waste receptacles for construction waste or debris is not allowed. The contractor shall make provisions for jobsite waste management and coordinate deliveries and collection of waste and recycling dumpsters within the job site.

### **Utility Locates:**

Contractors must call for a utility locate prior to any excavation. Many utilities on campus will be located by UI Facilities personnel, but they receive notification through the locate service for this area. The locate service is Digline (in Boise) at 1-800-342-1585 or (208) 342-1585. Digline may ask if the caller has the geographic location of the U of I. It is 39 North, Range 5 West, Section 7

### **Tree and Landscape Protection:**

The existing campus trees and landscaping are a valuable university resource and shall be protected as such. Refer to the Division 32 "Exterior Improvements" section for detailed landscape protection requirements. Landscape protection requirements shall be included by the Design Professional in the specifications for every project.

## **01 31 00 Project Management and Coordination**

### **Contractor Superintendent and Job-Site Staffing**

Regardless of project size or value, all contractors holding a contract with the UI must provide a qualified general superintendent or foreman. The contractor shall submit a resume and/or other documents showing basic qualifications of the designated superintendent. The superintendent's qualifications will be reviewed by the University, and if the qualifications are not commensurate for the requirements of the project, then the UI will ask the contractor to provide another selection for superintendent. If the superintendent is away from the project for any reason, the Contractor will have a designated backup (also to be approved by the UI) to supervise the project site.

The project superintendent, or designated backup, must be present on the job site anytime work is taking place, whether it be self-performed or performed by sub-contractors. No exceptions unless previously authorized by the UI CM. No changes of the superintendent are allowed without prior consent of the UI PM and/or UI CM. This position must provide a contact phone number to the A/E and UI and must be available for after-hours emergency contact by UI Construction Management and/or the prime Design Professional.

If any contractor holds more than one contract with the University at the same time, then a separate superintendent is required for each jobsite/contract unless a specific waiver is granted by the University of

Idaho Construction Manager or University of Idaho Project Manager.

On larger projects or specialty construction, other positions or additional staffing by the Contractor may be required. Requirements for additional staffing will be specified in the project documents, and may include:

- **General Superintendent**  
It is assumed that this individual will represent the contractor primarily, and will be responsible for coordination of subcontractors, technical aspects of the construction, maintenance of the schedule, generation of Requests for Information and similar duties.
- **Project Engineer / Document Administrator**  
This position will be primarily responsible for coordination and liaison with the owner's project team. He or she may also be responsible for safety meetings, pre-installation meetings, maintenance of as-built drawings, shop drawing and submittal coordination and distribution, monitoring and logging of site visits, and other functions typical of a Project Engineer or Quality Control Officer. This position will also be responsible for coordination with subcontractors and vendors contracted by the owner.
- **Contracts Specialist / Administrative Assistant**  
This position handles job-site communications, filing, correspondence, distribution of minutes, drafts of pay applications and generally ensures that the job office is staffed during the normal 40-hour work week.

### **Emergency Contact**

The contractor must provide the name and phone number of a designated local employee or resident who is generally available evenings and weekends to respond to emergencies on the job-site. This is not an on-call position, but the phone number provided must be equipped with voice mail or texting to ensure a timely response.

### **Safety Meetings**

The contractor shall conduct a job-site safety meeting each week. Attendance will be required by all employees of every subcontractor. The meeting should be of sufficient duration to cover the topic of the week, and to solicit input on safety concerns from the employees present. An attendance sheet shall be provided as evidence of those meetings and the agenda.

### **UI Stakeholder Coordination**

A designated member of the contractor's on-site staff, in conjunction with the UI Project Manager, may be required to conduct periodic meetings with stake-holders or user-groups selected from the campus community who are most impacted by the construction activity. This will be for a two-way exchange of information, keeping the owner's constituents aware of scheduled activities, and responding to impacts and dangers created by the project. The contractor's representative must have the authority to respond to issues raised in this meeting.

### **Information at Job Site**

Regardless of the size of the project, unless otherwise authorized by the UI Construction Manager, the Contractor's job site superintendent should have, at minimum, the following information on site and/or readily available for review:

- All Building Permits and Inspection Checklists
- A full set of drawings and specifications with up-to-date corrections showing all documented changes and as-built conditions.
- Material Safety Data Sheets (MSDS) as applicable.
- Approved shop drawing submittals.

## **01 33 00 Submittals**

### **Schedule of Values**

- The Schedule of Values must include a line item and valuated cost for Project Closeout.
- The Schedule of Values must include a line item and valuated cost for Commissioning (when applicable).

### **Construction Schedule**

On projects over \$500,000, or unless otherwise directed by the DP, the contractor shall produce a Critical Path Method (CPM) schedule. The schedule shall be updated every month by means of an actual progress bar underlying the initially-scheduled work bar for each activity. The overall completion date for the project may not be extended or decreased on the CPM schedule until a change order reflecting the new completion date has been signed. In addition, the contractor shall produce an abbreviated, two-week look-ahead, bar chart schedule for use by the subcontractors, the Owner's project team and the campus Stakeholders Group.

### **Overstock and Spare Parts**

Overage (spares and/or extra stock) in the amount of 10% shall be provided for acoustical ceiling tile, acoustical wall treatment, floor tile, carpet, ceramic tile, and other materials unique to the project. The DP shall review this percentage with the UI PM for reasonable adjustments in quantities based on the scope of the project. On larger projects, for example, a 10% requirement for some items can lead to an inordinately large amount of extra stock. Spare parts and extra stock requirements shall be developed for each specification section as coordinated with the UI PM.

The Design Profession shall develop an extra stock transmittal / log form that lists all extra stock items required in the specifications. The Owner and the Contractor will initial / sign-off on each item as it is delivered.

No leftover paint products or partially filled paint cans should be left on UI projects unless specifically instructed in writing. All paint codes and draw down sheets are required in the O&M Manuals. A schedule of paint colors shall be included in the O&M Manuals.

## **01 41 00 Regulatory Requirements**

The Design Professional will submit documents to the Division of Building Safety for plan review and approval prior to acceptance of a Contractor Bid. The Owner will pay for the DBS plan review fees.

The Contractor will obtain and pay for the Division of Building Safety Building Permit, and coordinate DBS inspections and observations of the work as required before work is covered. Plumbing and Electrical subcontractors shall obtain Division of Building Safety (DBS) permits and call for inspections by DBS before work is covered.

The Contractor shall include the cost of all permits in the base bid pricing unless otherwise specified in the Bid Documents. DBS Building Permit Fee charts and calculators can be found at the following location: <https://dbs.idaho.gov/programs/building/index.html>

No local (city or county) permits are required.

### **Utility Locates:**

Contractors must call for a utility locate prior to any excavation. Many utilities on campus will be located by UI Facilities personnel, but they receive notification through the locate service for this area. The locate service is Digline (in Boise) at 1-800-342-1585 or (208) 342-1585. Digline may ask if the caller has the



geographic location of the U of I. It is 39 North, Range 5 West, Section 7

## **01 45 00 Quality Control**

### **Inspections and Testing**

Contractors working on University of Idaho projects shall familiarize themselves with all items that require inspections and/or testing and will be expected to plan the work accordingly to allow for timely inspections that do not slow down or impede the work. Local inspectors can typically be on site in a timely manner and relatively short notice, the success of which will be greatly increased with advance planning and communication from the contractor.

On larger or more complex projects, it may be in the best interests of the Owner and Contractor to schedule a Pre-Inspection Conference with the Owner, the local DBS Inspector, and the Owner's Special Inspections Agency before the start of construction. The Pre-Inspection Conference will outline the project schedule, review all required code inspections, review all required special inspections, and establish a process for communications and notifications between all parties.

Special Testing Services (compaction, concrete cylinders, welding, etc...) will be contracted separately between the Owner and a qualified testing agency. The Contractor will be expected to coordinate special inspection notices with the testing agency as required.

The University of Idaho reserves the right to inspect all phases of work with UI personnel. The UI CM and UI CI will conduct regular inspections to monitor work progress and ensure that work and equipment installation is being completed in conformance with UI standards.

## **01 50 00 Temporary Facilities and Controls**

### **Temporary Utilities**

The Contractor may make temporary construction connections to any campus utility at the direction of the appropriate UI authority.

Electricity will not be billed to the contractor. Electricity shall not be used as the primary source for temporary jobsite heating.

Water will not be billed to the contractor.

Steam will not be billed to the contractor. Provisions can be made to use campus steam for temporary jobsite heating, but the contractor must make provisions to return steam condensate to the UI steam system under direction from the UI Steam Plant / Utilities and Engineering Services.

### **Construction Site Lay-Down and Storage:**

The use of University of Idaho property for lay-down/storage or parking is under the supervision and sole discretion of the University of Idaho Project Manager (UI PM) and/or the University of Idaho Construction Manager (UI CM). The UI PM, UI CM, and the Design Professional will attempt to identify available space(s) prior to the bidding of projects. The use and size of lay-down/storage space is subject to change during the course of the project should any conflict with UI operations arise. All contractors and subcontractors working on UI property must comply with these guidelines and as outlined in the contract documents including project meeting minutes and all instructions contained therein.

If a change or reduction in lay-down/storage area is required, the UI PM or UI CM will make every effort to locate and identify other areas on campus for additional construction lay-down/storage. Consideration and effort will be made to minimize impacts to the progress of construction.

The use of UI property for lay-down/storage does not grant a contractor the indiscriminate use of the designated area for parking or excessive or unnecessary storage.

Unless otherwise instructed or approved, lay-down/storage areas shall be enclosed with six foot (6'-0") high chain link fence and must be secured at all access points with a padlock or equal device capable of securing the area against unauthorized entrance.

Rehabilitation and restoration of all areas used as lay-down and storage space must conform to the directions listed in the Section II - Technical Standards as well as all directions outlined in the construction documents to include project meeting minutes and/or written direction from UI Landscape Exterior Services (UI LES).

Long term storage of trailers, vehicles, or other equipment is not allowed on UI property unless prior arrangements have been made with UI Parking and Transportation Services. Removal of any items will be at the cost of the Contractor and may be held out of retained contract funds.

Fire apparatus and emergency vehicle access to buildings and structures shall be maintained at all construction site laydown and storage areas. The contractor will be expected to review and coordinate construction fencing and barrier requirements, when applicable, with the Moscow Fire Department, and provide access as required.

## **01 55 00 Vehicular Access and Parking**

### **Site Access on Campus**

All vehicle, equipment, trucking, and delivery access to the project site will be coordinated with, and approved by, the UI CM and UI PM. The UI CM and the Contractor will develop a Site Access and Vehicular Safety Plan that is unique to each project. The site access plan is subject to change if conflicts with, or changes in, UI operations should arise. Site access restrictions and vehicular routing may require temporary changes or modifications to accommodate special campus events or activities.

The Contractor, including all associated sub-contractors, laborers, staff and vendors under the Contractor's supervision, MUST adhere to the approved Site Access and Vehicular Safety Plan. These plans are developed to protect University staff, students and visitors and to prevent contractors and suppliers from inadvertently causing damage to campus landscape, hardscape and/or steam tunnels.

If a construction project requires large equipment, deliveries, or cement trucks to access the site through sensitive or congested sections of the campus, then the UI PM or UI CM may require that all trucks and/or equipment be accompanied by additional spotters. In some cases, equipment, truck and delivery access may be restricted to certain hours of the day.

The UI AES team will make every effort to facilitate site access in a manner that will not impede the construction progress or schedule.

### **Class Changes**

The majority of university classes are scheduled between 8:30am and 5:30pm. Classes typically let out at 20-minutes past the hour and reconvene at 30-minutes past the hour. The campus will be filled with students for that 10-minute period between class changes. Contractors, on any size of construction project, are highly encouraged to restrict any vehicle access, equipment moving or material deliveries during the class change windows. This approach is safer for students, and ultimately, more convenient and expedient for the Contractor.

### **Construction Parking Guidelines:**

#### UI Parking and Transportation Services

UI Parking and Transportation Services, (UI PTS), provides parking arrangements and guidelines for all parking on UI property. Contractors and subcontractors working on UI property must comply with all University of Idaho Parking Regulations. Information can be found at: [www.uidaho.edu/parking](http://www.uidaho.edu/parking)

Construction parking is limited on campus and will be determined and regulated solely by UI PTS in cooperation with UI Architectural and Engineering Services (UI AES). Parking availability will depend on the scope and location of the work to be done.

UI PTS requires a minimum of 1-week notice to close any UI parking lot. Shorter notice may be approved for individual spaces.

#### Essential Vehicles

Only Essential Vehicles will be allowed at all UI construction sites or lay-down areas. The determination of what is an “essential vehicle” will be made by the UI CM and UI PTS. Examples may include: superintendent’s vehicle, dump trucks, loaders, forklifts, foreman/service vehicle (limit one per trade unless prior arranged), and other vehicles whose continuous presence is required to perform tasks.

Vehicles allowed to be parked at the construction site or in the core of campus will be restricted by the constraints of the project location and may change during the project if deemed necessary by UI PTS or the UI CM. If parking for personally operated vehicles is not available at the construction site, an alternative parking location(s) will be located as close as practical to the construction site by UI PTS.

#### Personally Operated Vehicles

No Personally Operated Vehicles (POV) will be allowed inside a fenced construction site or in the core of campus unless specific authorization is granted by the UI PM, UI CM, or UI PTS.

Personal and non-essential work vehicles that need to park during the workday may obtain temporary construction parking permits through UI AES.

#### Parking Permits and Citations

Parking permits are required in all campus parking lots Monday – Friday, 6:00am -5:00pm. Overnight or long-term parking is not allowed. Construction parking permits are valid in all Red, Blue, Silver and Green parking lots. During summer and academic breaks, permits will not be required in Red, Blue, Silver, or Purple parking areas.

All citations issued, must be paid or appealed within fifteen (15) days per UI Parking and Transportation Services policies. All citations may be paid or appealed online at: [www.uidaho.edu/parking](http://www.uidaho.edu/parking) . The UI PM, UI CM or UI CI cannot void or cancel any citations issued through UI PTS.

Contact UI Parking and Transportation Services for all questions regarding parking on UI property.

#### Parking Lot Protection

If one of the UI parking lots has been used as a construction lay down / storage yard, or if the parking lot has been otherwise disturbed by construction, then lot restoration/rehabilitation, at a minimum, will require re-grading of the areas (where applicable), magnetic sweeping for fine construction debris, nails, etc., and the placement of any parking bumpers and signage disturbed by the use of UI parking areas back to their original location.

¾” plywood or other suitable material is required to be in place to protect asphalt if tracked vehicles are used.

Heavy equipment and/or concrete trucks are not allowed in UI parking lots without prior approval by the UI CM or UI PTS. This requirement is in place to protect parking lots from unintentional damage due to overloading of the 2-inch nominal paving systems found in most parking areas.

Paved areas on campus are not to be used for the storage of gravel, dirt or other similar grading materials without prior agreement with UI/AES or PTS for seal-coating and/or re-striping.

## **01 77 00 Closeout Procedures**

### **Certificate of Occupancy**

The State of Idaho DBS will issue a Certificate of Occupancy or a Certificate of Completion.

The building will not be considered Substantially Complete until the DBS inspector agrees that the building is ready for occupancy and is ready to issue the Certificate of Occupancy or Completion. However, the DBS Certificate of Occupancy does not, by itself, indicate that a project has reached Substantial Completion until the other requirements outlined by the project specifications and Chapter 12 of the Section I - Design Guidelines have been met.

The Design Profession and Contractor shall refer to the bidding and contract requirements outlined in the UI Boilerplate and refer also to Section I – Design Guidelines; “Chapter 12 – Project Closeout” for project closeout requirements and required paperwork.

### **Operation and Maintenance (O&M) Manuals**

Three bound copies of the O&M Manuals are required unless otherwise directed by the UI PM.

O&M manuals must contain a copy of all approved product and equipment submittals along with the associated operation instructions, maintenance instructions and warranty information for each product as applicable. Information should be organized similarly to the project specification sections.

O&M manuals shall include a schedule of finishes that lists colors, models, and manufacturers of finish products, including: plastic laminates, paint, base, carpet, resilient flooring, ceramic tile, ceiling tiles, etc...

The Design Professional shall review drafts of the O&M manuals to make sure all items are included and properly organized prior to delivery of the manuals to the Owner.

# DIVISION 02 – EXISTING CONDITIONS

## **02 21 00 Surveys**

### **General**

The Design Professional shall reference or include in the technical specifications any Owner provided Geotechnical Reports, Soils Borings Investigations, and/or Hazardous Materials Surveys as applicable. (Refer to Section 1 – Design Guidelines; “Chapter 6 – Surveys, Testing and Commissioning”.

### **Site Surveys**

A site survey, when required, will be supplied by the Owner to the Design Professional and Contractor.

### **HABS / HAER Documentation**

If any significant University buildings are demolished or removed as part of a construction project, then the Owner shall document the existing structure following the guidelines of the National Park Service’s Heritage Documentation Programs, to include HABS / HAER guidelines. The AES Director shall determine which buildings warrant HABS / HAER documentation.

The purpose of this documentation is to preserve an accurate record of historic properties that can be used in research and other preservation activities. To serve these purposes, the documentation must include information that permits assessment of its reliability.

HABS/HAER/HALS records include both formal documentation (drawings, photographs, histories) and informal documentation (field records, and other significant materials not meeting HABS/HAER/HALS standards):

- Measured drawings are produced at a precise scale from actual dimensions recorded in the field. Drawings may be produced either by hand or with computer-aided drafting (CAD).
- Large-format photographs are produced as contact prints from 4x5, 5x7, and 8x10 black-and-white negatives and color transparencies. The formats allow maximum enlargement with minimal loss of detail and clarity, and the black-and-white processing allows for archival stability.
- Written histories place the site or structure within the appropriate context, addressing both the historical and the architectural or engineering aspects of its significance.
- Field records are not considered formal documentation because they are the notes, sketches, 35 mm or digital photographs, and field measurements used to create the drawings. Nevertheless, they are the primary source of HABS/HAER/HALS measured drawings and can reveal aspects of a structure or site not emphasized in the formal documentation. They are an important record of the documentation process, and often provide the greatest detail. In addition, field records may include copies of historical views or documents.

## **02 82 00 Asbestos Remediation**

### **General**

Asbestos Hazard and Emergency Response Act (AHERA) is the U.S. Environmental Protection Agency

(EPA) regulation requiring education facilities to inspect asbestos- containing materials (ACM), prepare an asbestos management plan and perform asbestos actions specific to the regulation.

Asbestos Containing Material (ACM) is any material that contains one percent or more asbestos by weight. Common examples of ACM include but are not limited to: pipe and boiler insulation, sprayed on fireproofing, troweled-on acoustical plaster, floor tile and mastic, floor linoleum, asbestos- cement board or shingles, roofing materials, wall and ceiling plaster or joint compound, ceiling tiles, and gasket materials.

#### Categories of Asbestos Work

According to federal regulation CFR 1926.1101, removal or maintenance of Asbestos falls under one of four categories:

- **Class I** asbestos work means activities involving the removal of TSI and surfacing ACM and PACM.
- **Class II** asbestos work means activities involving the removal of miscellaneous ACM. This includes, but is not limited to, wallboard, floor tile and sheeting, roofing and siding shingles, and mastics.
- **Class III** asbestos work means repair and maintenance operations, where ACM, including TSI and surfacing ACM and PACM may be disturbed.
- **Class IV** asbestos work means maintenance and custodial activities during which employees contact but do not disturb ACM or PACM, such as stripping ACM floor tile.

#### UI Environmental Health and Safety (EHS)

The University of Idaho Environmental Health & Safety (EHS) Department maintains the University's Interim Asbestos Management Plan and is responsible for overseeing compliance with the plan, and applicable regulations and policies. EHS will provide consultation services and assistance with rule application, interpretation, program policies, and work practices. The EHS industrial hygiene team will review all construction and alterations projects and periodically review progress to ensure compliance with the plan, and applicable regulations and policies.

EHS has overall responsibility to assure compliance with the regulations that govern the management of regulated building materials on UI properties. The EHS Industrial Hygienist is the responsible official with regulatory agencies (IDEQ, EPA).

UI Architectural & Engineering Services (UI AES) is responsible for planning building alterations, renovation and/or maintenance work. UI Project managers must contact EHS with any upcoming projects to determine if regulated materials may be impacted by the work. EHS is the determining factor for asbestos oversight and must be informed during the planning stage of any project that might impact ACM.

#### Capital Projects

Capital projects that impact ACM must include EHS for oversight to review records and survey all areas within the scope of the project for ACM. Project managers must use UI EHS or an AHERA-certified consultant for survey, design and abatement work for capital projects. UI EHS will make the determination as to whether they will self-perform asbestos material testing and verification or recommend the contracting of a third-party hygienist. All samples associated with asbestos surveys must be analyzed by an accredited National Volunteer Laboratory Accreditation Program (NVLAP) laboratory, sampling results shall be provided to the UI PM and reviewed by EHS.

The hazardous materials survey should be completed at the beginning of the design phase to ensure that any asbestos remediation strategies can be incorporated into the planning and estimating for the project. The hazardous material survey will be included as supplemental information in the bid documents as applicable.

If asbestos containing material is determined to be present on a project or site, the UI PM, UI EHS and the Design Professional shall formulate a strategy for remediating asbestos containing materials. Options will be based on project size and scope and may include:

- Removal of asbestos items by certified UI staff / hygienist. (This option is typically only used if there are small or limited quantities of asbestos materials.)

- The UI will ask the Design Professional (DP) to incorporate the abatement scope into the design / bid documents and specifications. The UI will contract a qualified industrial hygiene firm to provide third party oversight and clearance testing, or the DP's subconsultant may be utilized in the same manner.
- The UI will contract directly with a certified asbestos abatement company to remove asbestos materials from the project site prior to, or in conjunction with, other construction activities.
- For large abatement projects, the UI may elect to conduct a dedicated project, or "Phase I", aimed primarily at asbestos abatement and related demolition. Under this scenario, the UI will contract with a qualified consultant team to provide bid documents and specifications related to asbestos abatement and demolition. The demolition and abatement package will be bid as a stand-alone project with the intent to "clean" the site or project area prior to any "Phase II" renovation or construction work. The UI will hire a qualified industrial hygiene firm to provide third party oversight and clearance testing.

If the contractor encounters any asbestos material during the normal course of construction, or any material that may be considered suspicious or questionable as having asbestos content, then all work shall be stopped in the impacted area immediately. The contractor shall secure the area and contact the UI PM or UI CM immediately. If occupants in adjacent spaces or buildings have the potential to be impacted, then appropriate containment shall be placed around the impacted area. The UI PM will coordinate with UI EHS to provide expedient evaluation and testing of the suspect material. If a material is identified to contain asbestos, the contractor shall maintain appropriate protection and containment until the asbestos remediation plan is established.

In general, all abatement work on campus shall involve the services of a firm that is regularly engaged in the business of hazardous material abatement. This firm must employ, or have access to, an industrial hygienist. The contractor shall produce, through the assistance of the abatement firm, a Work Plan which describes how the abatement activities will take place. The Work Plan will be submitted to UI EHS for approval before any abatement work may begin. UI EHS is the final authority for acceptance of the plan. The Work Plan must contain, at least, the following:

- Name and address of individual (hygienist or principal of firm) who will be responsible for the abatement procedures.
- Contractor licenses.
- Name and address of testing lab.
- Description of testing procedures and levels of measurements.
- Worker certifications and worker medical clearance information.
- Removal methods.
- Description of procedures that will be used to protect the personnel involved in the abatement effort.
- Description of procedures that will be used to ensure adequate separation and protection of the campus community from the abatement work.
- Daily air monitoring results and final clearance results.
- Identification of hazardous waste storage facility or sanitary landfill which will be used for the disposal of the asbestos material.
- Description of the tracking mechanism(s) that will be used throughout the process, including all necessary forms and testing sequences.
- Describe the final closeout, clearance and approval process. Closeout information must include all disposal manifests, daily logs and workers that performed work on site.

An EPA Notification of Demolition and Renovation permit must be obtained by the Contractor two weeks prior to the start of any work involving hazardous material abatement or selective demolition. There must be a separate permit for each structure. Application for this permit must be coordinated through the University of Idaho Environmental Health and Safety Office (EH&S).

## **02 83 00 Lead Remediation**

The UI PM, in coordination with the University of Idaho Environmental Health and Safety Office (UI EHS), will

provide evidence of lead containing paint, coatings or materials in existing construction. This procedure shall be followed for all projects regardless of size, scope, or location.

UI EHS will make the determination as to whether they will self-perform lead material testing and verification or recommend the contracting of a third-party hygienist to perform a detailed lead survey.

The lead materials survey should be completed at the beginning of the design phase to ensure that any remediation strategies can be incorporated into the planning and estimating for the project.

If lead containing paint, coatings or material is determined to be present on a project or site, the UI PM, UI EHS and the Design Professional shall formulate a strategy for removal of lead materials. Options will be based on the levels and amounts of lead containing materials and may include:

- If the percentage of lead quantities are determined to be minimal and may be disposed in an approved landfill as unclassified construction debris, then the DP shall direct the contractor to implement lead safe work practices during material demolition and/or disruption as per OSHA requirements and guidelines. The UI will require, at a minimum, the erection of rigid framework and plastic sheet dust barriers to separate the work from the building occupants.
- The UI will ask the DP to incorporate the lead remediation scope into the documents and specifications for a project. This will typically require the DP to have a specialty subconsultant on their team who is a qualified industrial hygienist. The remediation scope will be incorporated into the bid documents and removed under the scope of the General Contractor. A GC might be able to perform lead abatement with appropriate training and work methods as approved by the IH and UI EHS. The UI may contract a qualified industrial hygiene firm to provide third party oversight and clearance testing, or the DP's subconsultant will be utilized in the same manner.
- The UI will contract directly with a certified abatement firm to remove lead materials from the project site prior to, or in conjunction with, other construction activities.
- For large remediation projects, the UI may elect to conduct a dedicated project, or "Phase I", aimed primarily at lead remediation and related demolition. Under this scenario, the UI will contract with a qualified consultant team to provide bid documents and specifications related to lead material removal and demolition. The demolition and remediation package will be bid as a stand-alone project with the intent to "clean" the site or project area prior to any "Phase II" renovation or construction work. The UI will hire a qualified industrial hygiene firm to provide third party oversight and clearance testing.

In general, unless specified otherwise, all lead remediation work on campus shall involve the services of a firm that is regularly engaged in the business of hazardous material abatement. This firm must employ, or have access to, an industrial hygienist. The contractor shall produce, through the assistance of the abatement firm, a Work Plan which describes how the abatement activities will take place. The Work Plan will be submitted to the UI EHS for approval before any remediation work may begin. UI EHS is the final authority for acceptance of the plan. The Work Plan must contain, at least, the following:

- Name and address of individual (hygienist or principal of firm) who will be responsible for the abatement procedures.
- Name and address of testing lab.
- Description of testing procedures and levels of measurements.
- Description of procedures that will be used to protect the personnel involved in the remediation effort.
- Description of procedures that will be used to ensure adequate separation and protection of the campus community from the work.
- Waste stream characterization and disposal procedures if deemed hazardous.
- Description of the tracking mechanism(s) that will be used throughout the process, including all necessary forms and testing sequences.
- Daily air monitoring results and final clearance results.
- Describe the final closeout, clearance and approval process. Closeout information must include all disposal manifests, daily logs and workers that performed work on site.



# DIVISION 3 - CONCRETE

## **03 30 00 Cast-In-Place Concrete**

### **General**

Concrete trucks are not allowed to dump excess material or to be washed off anywhere on campus. The Contractor shall coordinate with the concrete deliveries to make other arrangements.

The Contractor shall coordinate the access routes of all concrete trucks with the UI CM and UI PM. Refer to "Division 1 – General Requirements" of these standards for more information on vehicle access on campus.

### **Sidewalks**

Unless otherwise directed, all sidewalks on campus shall be constructed to the following requirements:

- 6'-0" wide to accommodate small tractor mounted snow plows.
- 6" thick.
- 3000# concrete.
- Reinforced with 6x6 welded wire mesh or No. 4 rebar at 16" in center each way.
- ¼" per foot maximum cross-slope.
- Standard broom finish
- A penetrating sealer applied.

Refer to "Division 32 – Exterior Improvements" of these Design Guidelines and Construction Standards for additional requirements related to campus walks.

### **Protection of Concrete**

The Contractor is responsible for security and protection of freshly poured concrete on campus. The Contractor shall erect all necessary security and/or protection barriers and provide monitoring of freshly poured concrete as required. If unmonitored concrete is disturbed or vandalized before hardening, the Contractor is responsible for replacing that concrete.

The contractor shall monitor weather conditions and schedule concrete pours accordingly. Protection of recently poured flat work or exposed concrete finishes from inclement weather, rain and/or hail shall be the responsibility of the contractor. Exposed concrete finishes marred by rain or hail will not be accepted by the Owner.

The contractor shall employ cold weather protection as necessary when placing concrete during the winter months. This may include ground protection blankets, ground thawing equipment, formwork protection blankets, tenting and/or temporary heating as required. Project specifications shall outline cold weather protection requirements and specialized concrete mix designs as applicable.

### **Architectural Grade Exposed Concrete Walls**

The use of exposed, architectural grade concrete walls is generally discouraged or recommended to be implemented in smaller quantities or areas within a project. Historically, it has been difficult to obtain the specified quality of exposed concrete in the Palouse region, often leading to secondary efforts to repair, replace or cover exposed concrete finishes. Design Professionals are encouraged to take this into consideration in the design of the project. Coordinate with the UI PM.

## **03 35 00 Concrete Finishing**

### **Polished Concrete**

The University prefers ground / polished concrete floors in high traffic areas such as corridors, lobbies, stairwells, etc... The level of grinding will be dependent on aesthetic goals and budget.

Grinding of existing concrete floors is allowed and preferable in some cases. The DP will include specifications for crack filling and hardening of existing slabs where required.

The DP shall require that the Contractor provide a full-size mock-up or test area for grinding and polishing prior to final acceptance. The mock-up / test area should be at least 50 square feet and may be located in an area that will be hidden or covered by other finishes.

### **Stained Concrete**

Stained concrete is allowed, but the DP shall work with the UI PM to carefully coordinate a color. Generally, grey and/or darker colors are preferred.

The DP shall require that the Contractor provide a full-size mock-up or test area showing the stain color prior to final acceptance. The mock-up / test area should be at least 50 square feet and may be located in an area that will be hidden or covered by other finishes.

# DIVISION 4 - MASONRY

## **04 05 00 Masonry**

### **Demolition**

The contractor shall attempt to salvage any removed brick for potential re-use or patching in the project unless otherwise directed. The contractor shall verify if the UI wants to keep any salvaged brick in the facilities storage yard for future use or patching. If not, then the brick may be disposed of normally.

### **Restoration**

Special attention shall be paid to match existing stone, brick, mortar colors and mortar joints while working on any of the historic UI buildings. The Design Professional and Contractor will verify if the Owner has any extra stock or original matching brick in the facilities storage yard.

### **Mock-Up Panels**

Mock-up panels are required for all masonry projects whether it is new masonry or restoration of existing masonry. Mock-up panels shall be a minimum of 36 square feet and are required to be constructed by the actual workers who will be installing the masonry and shall feature the exact specified and approved products and installation methods. Restoration mock-up panels can be done on a specified area of existing masonry wall in a location coordinated with the UI PM or UI CM.

### **Protection**

Masonry work shall not be constructed without heating or protection when the ambient temperature is below 40-degrees.

The Design Professional shall design to prevent efflorescence and include construction specifications for moisture protection during construction for all masonry. Designs shall prevent moisture from entering finished masonry walls and avoid unprotected horizontal sills. Designs shall seal out moisture, and every feature should drain or dry without absorbing moisture. Design wall systems with appropriate measures to prevent moisture transfer from building interiors. Include initial cleaning of masonry by the mason or contractor after first winter after building acceptance in contract specifications.

The tops of all exposed masonry walls shall receive a watertight cap or coping, i.e., sheet metal or precast concrete, to prohibit moisture infiltration and efflorescence.

To further guard against efflorescence, the Contractor shall protect all masonry wall systems from the intrusion of water during installation and erection. The open tops of in-progress walls should be protected against rain, and masonry wall systems shall be immediately covered and/or protected upon completion by either the permanent caps and/or copings, or by temporary protection as necessary.

### **Cleaning**

All masonry work shall be cleaned and sealed before final inspection and acceptance. Only use non-acidic detergents or agents for cleaning. Contractor shall be required to submit proposed procedures and to provide samples of materials where cleaning methods have been tested prior to beginning cleaning operations.

# DIVISION 5 - METALS

## **05 50 00 Metal Fabrications**

### **Standard Details**

Refer to Section I – Design Guidelines; “Chapter 6 – Standard Design Elements and Details” for UI standard details for bollards, bike racks, exterior signage, etc ...

### **Fabrication**

All handrails, bike racks, interior stair rails and similar tubular metal structures shall be constructed by hydraulic bending or the use of butt-weld ells. No mitering will be allowed unless specified otherwise in the details. All welds shall be ground flush and smooth and shall be free of defects or other burs.

Pipe rails shall be attached to concrete surfaces by direct welding to a separate weld-plate, with re-bar J-hooks, embedded in the concrete.

### **Coatings**

Exterior and interior railings and other metal fabrications that are in high traffic areas should be powder-coated for durability when possible. Coordinate with the UI PM.

If powder-coating is used, the Contractor shall request inspection and approval of all metal fabrications by the DP or the UI PM prior to powder-coating. The Owner or DP will arrange to make off-site visits, if necessary, to inspect metal fabrications before powder-coating and delivery to campus. If metal fabrications are rejected and/or require revisions due to quality or workmanship issues that were not reviewed by the DP or Owner prior to powder-coating, the Contractor will be responsible for having powder-coating touched-up or reapplied.

Shop apply coatings to the greatest extent possible.

### **Access Ladders and Maintenance Walks**

Specify and fabricate code-compliant ladders and work platforms for safe maintenance access. The Design Professional shall refer to the State of Idaho, Division of Building Safety “General Safety & Health Standards” for guidelines and requirements related to service ladders, maintenance access, and service platforms.

[https://dbs.idaho.gov/safety\\_code/](https://dbs.idaho.gov/safety_code/)

### **Fall Protection**

Provide fall arrest anchors, appropriately located on or around roofing systems, as a point of tie-off for UI maintenance work.

# DIVISION 6 - WOOD

## **06 40 00 Architectural Woodwork**

### **Architectural Casework**

All casework must meet the Architectural Woodwork Institute's "Quality Standards (Current Edition)"; AWI Custom grade standards.

All materials shall be formaldehyde free.

All exposed cabinet hardware should be specified with a permanent, durable finish.

If cabinet locks are used, the lock shall be of a type and style that can accept a standard UI Schlage keyway. Coordinate cabinet locks with the UI PM and UI Key Shop.

### **Wood Trim and Paneling**

All wood paneling and running trim should meet the Architectural Woodwork Institute's "Quality Standards (Current Edition)"; AWI Custom grade standards.

If a custom trim profile is used to a significant extent, or if a custom cutting knife is created to match an existing or historic wood trim profile, the Contractor shall provide the custom knife, or a copy of the custom knife, to the University to be used for future trim maintenance, patching, or matching.

## DIVISION 7 - THERMAL AND MOISTURE PROTECTION

### **07 20 00 Thermal Protection**

The Design Professional is encouraged design exterior wall assemblies that exceed the thermal requirements required by the International Building Code and International Energy Conservation Code. Consider using rainscreen cladding systems that utilize drainage gaps, continuous insulation and high-performance air barriers designed for a high degree of energy performance and moisture resistance.

### **07 30 00 Roofing General Items**

#### **Roofing Contractor Warranty**

In general, the University of Idaho adopts and complies with the roofing requirements and warranties required by the State of Idaho, Division of Public Works.

Regardless of roofing type, the roofing contractor shall provide a **five (5) year** roofing warranty in addition to the roofing guarantee provided by the roofing manufacturer.

In summary, the roofing contractor will warrant, subject to terms and conditions set forth in the standard State of Idaho Roofing Warranty, that he will at his own cost and expense, make or cause to be made such repairs to or replacements as necessary to correct faulty and defective work, and as necessary to maintain the roof in watertight condition. In addition to making the work watertight, the roofing contractor shall remove and/or repair blisters, ridges, flashings, splits and other irregularities which in the opinion of the roofing manufacturer's technical representative do not conform to acceptable roofing practices and conditions. These repairs shall be made prior to expiration of the five (5) year warranty period and to the satisfaction of the roofing manufacturer's technical representative.

A complete copy of the State of Idaho Roofing Contractor Warranty, with all associated conditions and exceptions, can be found at the following location:

<https://dpw.idaho.gov/roofing/>

The Design Professional (DP) shall reference and include a full copy of the State of Idaho Roofing Contractor Warranty in the project specifications. The Division of Public Works letter head and footers shall be removed, but all content therein shall remain as applicable.

#### **Ice and Snow Build-Up**

Winter on the Palouse will often experience the right conditions for excessive ice damming and ice build-up. The Design Professional shall ensure that the flow of snow on roofs and the build-up of ice and/or icicles on all roof edges, parapets, canopies and other building projections has been considered during the design phase to mitigate falling hazards near entrances, walkways, pedestrian routes, or parking lots.

The DP shall likewise attempt to design facilities to prevent snow piling from roofs at walkways or entrances.

#### **Drainage**

All roofs shall be designed with a minimum drain slope of 1/4" per foot. Where existing roofs don't meet this standard, roofing retrofits shall add sloped insulation and/or crickets to bring existing roofs into compliance.

A minimum slope of 1/2" per foot is preferred on all new construction.

Provide overflow drains at each roof drain location. Overflow drains shall be plumbed to an overflow discharge outlet that is clearly visible on the exterior of the building. Do not plumb overflow drains to

discharge onto a lower roof.

## **07 31 13 Asphalt Shingles**

Where circumstances dictate, use 40-year architectural grade composition, laminated shingles similar to Owens Corning Oakridge 40 Deep Shadow. Standard practice includes the installation of ice and water shield at eaves, rakes, penetrations, valleys and two layers of 15# felt instead of a single layer of 30# felt.

Consider substituting underlayment with full coverage of self-adhesive ice and water shield where budget allows.

Shingles must be hand nailed. Staples are not allowed.

## **07 50 00 Membrane Roofing**

Membrane roofs may include the following systems as applicable for individual project requirements: (Coordinate selection with UI PM):

### **Thermoplastic Polyolefin Membrane (TPO)**

Approved Manufacturers:

- Carlisle Syntec, Inc.
- Firestone (Ultra-Ply)
- GAF (Everguard)
- JM International

### **Polyvinyl Chloride Membrane (PVC)**

Approved Manufacturers:

- Carlisle Syntec, Inc.
- Fibertite
- GAF
- Bond Cote Roofing Systems

### **Modified Bitumen**

Approved Manufacturers:

- Garland Co., Inc.
- IKO Research
- Johns Manville
- M.B Technology
- Performance Roof Systems

A complete listing of State of Idaho approved roofing manufacturers can be found at the following location:

<https://dpw.idaho.gov/roofing/>

Membrane sheets shall be minimum 60-mil thickness, or thicker, as required for manufacturers to meet the State of Idaho 30-year Single Ply Manufacturers Roofing Warranty.

Membrane roof systems shall be mechanically fastened or fully adhered. Ballasted systems should only be used where patching into existing ballasted systems or in special applications as approved by the UI PM.

Membrane roofing systems shall only be installed by roofers certified by the manufacturer to install the specified system. Installer certifications submission and review will be a requirement of the specifications / submittal review process.

Built-up roofing systems shall only be used where necessary to match existing.

## **Single Ply Roofing Warranty**

In general, the University of Idaho adopts and complies with the roofing requirements and warranties required by the State of Idaho, Division of Public Works.

In addition to the standard **five (5) year** Roofing Contractor Warranty, the manufacturer will warranty that its roofing, when applied effectively per specifications and manufacturers recommendations, is watertight for a period of **thirty (30) years**.

In summary, the manufacturer will guarantee that during a period of thirty (30) years from the date of substantial completion of the single-ply roofing, the manufacturer will at its own expense, make or cause to be made, any repairs that may be necessary, as a result of defects in workmanship or materials supplied by the manufacturer which results in leaks or of normal wear and tear by the elements which results in leaks, and will maintain said roof in water tight condition free from all leaks arising from such causes.

A complete copy of the State of Idaho Single Ply Roofing Warranty, with all associated conditions and exceptions, can be found at the following location:

<https://dpw.idaho.gov/roofing/>

The Design Professional (DP) shall reference and include a full copy of the State of Idaho Single Ply Roofing Warranty in the project specifications. The Division of Public Works letter head and footers shall be removed, but all content therein shall remain as applicable.

## **07 61 13 Standing Seam Metal Roofing**

Standing Seam metal roofing systems are featured prominently on many University buildings, especially within the core of campus. The use of standing seam metal roofing is encouraged, where applicable, from both a design aesthetic and performance standpoint.

### Approved Manufacturers

- Atlas International
- Butler
- Fabral
- Garland Co., Inc.
- MBCI
- Metal Sales

A complete listing of State of Idaho approved roofing manufacturers can be found at the following location:

<https://dpw.idaho.gov/roofing/>

Use gasketed standing seam for systems up to a 3:12 slope. Mechanically fastened standing seam systems are acceptable above a 3:12 slope.

Implement snow guards in all areas susceptible to sliding snow hazards.

## **07 64 19 Flat Seam (Low Slope) Metal Roofing**

The use of low slope metal roofing systems is currently discouraged on the UI campus. There are numerous examples of high-performing, water-tight low slope metal roof systems installed on campus. However, rigorous installation requirements, qualifications, training and oversight is required for a successful installation. Unless and until these regional installation / quality control issues are improved, the UI is implementing other roofing options as described herein.



## **Low Slope Metal Roofing Warranty**

If low slope metal roofing systems are used, the manufacturer must provide a special thirty (30) year State of Idaho Low Slope Roofing Warranty.

A complete copy of the State of Idaho Low Slope Metal Roofing Warranty, with all associated conditions and exceptions, can be found at the following location:

<https://dpw.idaho.gov/roofing/>

The Design Professional (DP) shall reference and include a full copy of the State of Idaho Low Slope Metal Roofing Warranty in the project specifications. The Division of Public Works letter head and footers shall be removed, but all content therein shall remain as applicable.

## **07 72 00 Roof Accessories**

### **Walk Pads**

Provide walkways, pavers or pads from all roof access points (roof access doors, hatches, or ladders) to all roof-mounted equipment. Walk pads shall, whenever possible, be located far enough from roof edges and parapets to negate the requirement for edge protection and/or guards. Verify placement with all codes having jurisdiction.

Walk pads shall be compatible with the roofing system. Verify with manufacturer specifications.

### **Snow Guards**

Provide snow guards on all sloped metal roofs where sliding snow could impact pedestrian walkways, parking lots, or building entrances.

Snow guards shall be compatible accessories to the specified roofing system and shall be installed per manufacturers recommendations.

### **Roof Hatches**

Locate roof hatches, whenever possible, far enough from roof edges and parapets to eliminate the need for edge protection or other guards.

Roof hatches shall be weather-tight, insulated, and meet all OSHA and/or other applicable codes and requirements having jurisdiction.

### **Fall Arrest Anchors**

Provide fall arrest anchors, appropriately located on or around roofing systems, as a point of tie-off for UI maintenance work.

## **07 84 00 Firestopping**

### **Firestopping & Smoke seals**

Firestopping products and systems shall be UL approved, and provided by a single manufacturer throughout the project, for all trades. In projects with more than twenty (20) fire-stopped penetrations, the work shall be done by a firm regularly engaged in this industry. Submittals shall be required for firestopping products and systems. The general contractor shall coordinate all firestopping requirements and submittals and will designate one subcontractor to assume this responsibility for all other trades.

# DIVISION 8 - OPENINGS

## **08 11 00 Metal Doors and Frames**

### **Exterior Metal Doors & Frames**

Exterior door frames to be hot-dipped galvanized, bolted to structure and painted.

Where exterior metal doors are located in areas prone to extended exposure to summer sun, avoid painting metal doors and frames dark colors to prevent swelling and jamming.

### **Interior Metal Frames**

No knockdown hollow metal frames allowed. All corners to be factory mitered and welded..

Interior doors to be supported with double, full-height studs on either side.

Interior frames will not be galvanized or grouted.

All doors shall be 3'-0" wide by 7'-0" tall standard unless otherwise required.

## **08 14 00 Wood Doors**

### **Flush Wood Doors**

Unless otherwise directed, on all interior doors in remodels shall match existing doors and species.

Doors shall meet ANSI/WDMA I.S.1A-13, Industry Standard for Interior Architectural Wood Flush Doors.

All flush wood doors shall be solid core unless directed otherwise. Doors shall carry a manufacturer's standard lifetime warranty against warping, splitting or delamination.

Use premium face veneers in all doors where transparent stains will be used. The use of endangered or limited tree species in wood veneers is not permitted.

Provide protective kickplates at all wood doors located in high-traffic or delivery areas.

## **08 33 00 Specialty Doors and Frames**

### **Overhead Coiling Doors and Grills**

Overhead coiling doors must use motorized opening and resetting features to allow them to be placed in service after fire testing without any additional tools.

## **08 40 00 Entrances, Storefronts and Curtainwall**

### **Entrances and Storefronts**

Double doors at storefront openings shall be equipped with a Von Duprin removable mullion equipped with a security lock with standard UI keyway. Refer to "08 71 00 Door Hardware".

Storefront systems shall match existing systems in all remodels and renovations unless directed otherwise.

Narrow stile doors are not allowed.

### **Translucent Wall and Roof Assemblies**

Translucent wall assemblies shall be designed and specified around Kalwall standard 2-3/4" or 4" panel systems unless otherwise directed.

The DP shall obtain samples and do site testing to determine which level of light transmittance and insulation value best meets the needs of individual projects.

## **08 71 00 Door Hardware**

### **Facilities Access Control Department (FACD)**

The Facilities Access Control Department (FACD), commonly known as the "Lock Shop", is responsible for creating and maintaining the University's lock and key system. Responsibilities include:

- Develop schematics, codes, and product standards.
- Service door and lock equipment across campus.
- Maintain key records of all keys, locks, and associated facility and room numbers.
- Restore physical security immediately when key control has been compromised.
- Installation of Card Access Systems.
- Key replacement.
- Construction support. (Provision and installation of temporary "construction" core cylinders)
- Issuance and authorization for temporary contractor access cards and keys.

### **General**

All hardware groups, lockset handle styles and hardware finishes shall be reviewed and approved by the University of Idaho. The Design Professional and/or the DP's hardware consultant shall review hardware systems and specifications with the UI PM and the FACD during the construction documentation phase. The Contractor's hardware shop drawing submittals shall be reviewed and approved by the FACD after the initial review by the DP, but prior to final approval.

The UI requires card-swipe access control systems and ADA push-button operators at most major building entrances. Coordinate with UI PM and FACD. Refer to "Division 28 – Electronic Safety and Security".

Card-swipe access control systems may be provided at interior building suites, IT closets and other such areas as required by the building program. Coordinate with the UI PM and UI Stakeholder Group. Refer to "Division 28 – Electronic Safety and Security".

Where pairs of doors serve as required exits from assembly occupancies, an exterior pull handle will be provided on only one leaf of each set to eliminate the potential of chaining or blocking doors via the handle sets. This may be considered at other locations other than assembly occupancies. Coordinate with the UI PM.

### **Cylinders and Keying**

Keying will be as directed by the UI FACD.

All permanent keys will be shipped direct from the factory by registered mail to: Key Shop Access Coordinator at Facilities, University of Idaho.

All keys, including blanks, shall be stamped, "**Prop. U of I - Do Not Dup.**" Keys shall be blank on one side for special stamping by owner. Provide keys of nickel silver only. Schlage 35-131

All Cylinders shall be provided “1 or 0” bitted. All building keying to be done by the UI FACD.

Full size, removable cores shall be used on all doors with exit devices.

### **Hanging Devices**

All door hinges shall comply with the following:

- Ives 5BB1HW 5 Knuckle Ball Bearing
- Non-rising and non-removable pins.

### **Securing Devices**

All Locksets and Cylinders shall be Schlage.

#### **L-Series Mortise Locks:**

Office:	L9050 P
Classroom:	L9070 P
Cust/Mech/Storage:	L9080 P
Restroom:	L9040
Passage:	L9010
Privacy Set:	L9456L L283-722 (with “Occupied” indicator)

#### **ND Series Cylindrical Locks:**

Office:	ND50 PD
Classroom:	ND70 PD
Cust/Mech/Storage:	ND80 PD
Restroom:	ND40 S
Passage:	ND10 S
Privacy Deadbolt:	B571 (with “Occupied: indicator)

### **Cylinders**

All Cylinders shall be Schlage; keyed to UI restricted keying specifications as noted above.

No double cylinders shall be installed on any doors.

### **Exit Devices**

Exit devices shall be:

- Von Duprin 99 & 33 Series
- **Use Rim Exit devices only:** Vertical rod devices must be pre-approved by the UI PM and the UI Facilities Key Shop

### **Closing Devices**

Mechanical Closers: LCN 4000 Series Surface Mount.

*Note: use closer of sizes recommended by manufacturer unless a larger size is specified. Adjust closer to comply with applicable codes. Use Parallel Extra Duty Arms (EDA).*

Auto Operators: LCN 4822 Auto Equalizer

### **Stops and Holders**

Overhead Stops: Glynn Johnson; 90 & 100 Series

### **Access Control Software**

Access Control Wireless: CBORD

Access Control Hardwired: CBORD

All CBORD Access Control equipment and devices to be provided and installed by the UI FACD. Conduit and pathway, when applicable, from specified door locations to Access Control equipment (typically in communications closets) will be included as part of Division 26. Power supplies will be provided as part of Division 8. Pedestals, recessed boxes and other support infrastructure for Access Control systems shall be included in the project specifications and supplied as part of the project.

Refer to Access Control Systems in “Division 28 – Electronic Safety and Security” for additional information.

**Power Supplies**

For Electric Strikes: Altronix AL1012ULXPD16 12V DC  
For QEL Push Bars: Von Duprin PS902 24V DC

Refer to Access Control Systems in “Division 28 – Electronic Safety and Security” for additional information.

**Electric Strikes**

Where access control systems require an electric strike at regular door jambs or non-removable mullions:

1. Heavy Steel Jamb where a Von Duprin 99 Exit Device is used: Von Duprin 6111 12V DC
2. Where a Schlage Mortise Lock is used: HES 1006 12/24D Electric Strike with KD Option
3. Where a Schlage Cylindrical Lock is used: HES 5200C 12/24D
4. Where a surface mount strike is needed for an Exit Device: HES 9600 12/24D
5. Where a strike is needed for exit devices at light duty / limited space areas: HES 7000 12/24D
6. Where a strike is needed for a mortise lock for Restroom/Mothers Room: Von Duprin 6400 Series

**ADA Operators (Pneumatic)**

Auto Operators: LCN 4822 Auto Equalizer  
Control Box: LCN ES7982 Control Box with Air Pump  
ADA Push Plates: LCN 8310 series

Refer to Access Control Systems in “Division 28 – Electronic Safety and Security” for additional information.

**Exterior Bollards for ADA Push Plates and Card Readers**

ADA push plates and Vandal Card Access readers should be mounted on the building wall next to entry doors where required. In some cases, the building design and/or existing conditions will not allow wall mounting and an exterior bollard may be required. Custom steel bollards that match the building architecture are allowed. The bollard shall be designed to mount both the push plate and the card reader where required. The bollard shall be designed to have an enclosed mounting box and backing that will accept standard LCN 8310 series push plate devices and a single-gang mounting box for card readers. The UI PM can provide examples of other bollard designs on campus. In lieu of custom bollards, the Design Professional may specify the following OEM bollard: LCN 8310-866FLA.

**Approved Manufacturers**

<u>Item:</u>	<u>Manufacturer:</u>	<u>Approved Equal / Substitute:</u>
Hinges:	Ives	Stanley
Continuous Hinges:	Ives	Pemko
Locksets:	Schlage	(No Substitute)
Cylinders:	Schlage	(No Substitute)
Exit Devices:	Von Duprin	(No Substitute)
Closers:	LCN	(No Substitute)

Push / Pull Plates:	Ives	Trimco
Push/Pull Bars:	Ives	Trimco
Overhead Stops:	Glynn Johnson	(No Substitute)
Door Stops:	Ives	(No Substitute)
Flush Bolts:	Ives	(No Substitute)
Threshold & Gasketing:	National Guard	
Access Control Software:	CBORD	(No Substitute)
Auto Operators:	LCN	(No Substitute)
Electric Strikes:	Von Duprin	(No Substitute)
ADA Push Plates:	LCN	MS Sedco
Power Supplies:	Von Duprin	Schlage

### **Storefront Door Systems**

Narrow stile frames are not allowed on aluminum storefront doors.

Locksets to be Schlage L-series, extra heavy duty. Verify finish with UI PM.

Hinges at storefront door systems shall be continuous hinges by Pemko unless noted otherwise.

Removable mullions at storefront door systems shall be Von Duprin, keyed.

Exit devices shall be Von Duprin 99 with 994L break away trim.

ADA openers shall be LCN 4822 pneumatic.

#### At Electrified Storefront Access Control Doors:

- Exit Device (standard): Von Duprin 99 Series
- Exit Device (electric): Von Duprin RX-QEL-99-CON (required at removable mullions)
- Power Transfer Hinge: Ives 112HD-EPT (where required)
- Power Transfer: Ives EPT CON (where required)
- Power Supply: Von Duprin PS902 series
- Interior Door Harness: Schlage CON as compatible (where required)

## **08 80 00 Glass and Glazing**

### **Exterior Glass**

Specify Low-E, Argon-filled glazing.

Color tinting is allowed in certain cases. Coordinate with the UI PM.

Design Professionals shall avoid highly reflective finishes to prevent glare into adjacent buildings and spaces.

### **Glass for Railings**

Where laminated safety glass is used for interior railings or guards, the Design Professional shall comply with the following:

- Include clear requirements and specifications for edge conditions, alignment, and polishing of panel edges. Laminated panels shall be perfectly aligned with no protrusions, irregularities, or chipping.
- Specify that all exposed edges must be sanded or polished smooth and free of sharp corners. The DP shall consider designing a truncated or chamfered detail at any exposed corners that are at an acute angle.

- Consider using an extruded aluminum top rail at all guards to avoid issues with exposed glass edges.
- Require the submittal of a minimum 12"x12" glass sample panel from the same manufacturer that will be supplying the glass. The glass sample must be approved prior to approval of the shop drawings.
- Require an on-site mockup with at least two (2) full size glass panels before approving the rest of the glass order. Mock-up panels may be "in place" and, if approved, can be use as part of the final installation.

# DIVISION 9 - FINISHES

## **09 05 00 General Requirements**

### **General**

The University prefers polished and/or stained concrete floors in high traffic areas. Refer to “Division 03 – Concrete” for additional information.

Ceilings must have access to mechanical / electrical equipment. Placement of equipment will be coordinated with ceiling layouts to ensure that service and maintenance access is available from a standard step ladder. If hard ceilings are installed, access doors shall be installed to provide access to all equipment and valves. The installation of hard ceilings should be minimized to allow for access and routing of future services.

A complete finish schedule shall be included in the O&M Manuals and shall contain the manufacture, model, and color of all floor, wall, tile and paint finishes. The finish schedule will include room numbers and will contain enough detail to outline accent colors on individual walls or other finish details, as necessary.

Where existing finishes are disturbed in construction remodels, the existing finish material (base, flooring, etc...) shall be removed to the nearest corner or wall break and replaced in that entire section. If existing paint finishes are disturbed, then the entire wall shall be repainted.

### **Odor Control**

Adequate isolation and ventilation must be employed when installing carpet, tile, vinyl goods, laminate, or any other products requiring adhesive. Building occupants must be given one week notice prior to the installation of any new finishes or materials requiring adhesives. Doors to occupied spaces must be closed, and other openings must be sealed with plastic sheeting. At a minimum, prior to the start of work, positive mechanical ventilation must be established with a fan drawing air from the work area to the atmosphere. The ventilation system must allow sufficient make-up air, and the air flow must not utilize corridors or other routes that would impact building users. The U of I Environmental Health and Safety Office (UI EHS) may monitor the air quality during installation and may recommend additional odor control measures as necessary.

Low VOC materials and coatings are required. Zero VOC materials and coatings should be used when possible.

### **Cleaning & Maintenance**

Avoid small nooks, corners and/or unnecessary small alcoves in corridors or lobbies. Corridors should allow for a clean sweep by industrial size cleaning machines.

Avoid mixing floorings, i.e. carpet and tile, where there are no clear dividing features.

Avoid carpeting in high traffic areas such as corridors or lobby areas.

Ledges and other such small or hard to access surfaces that will collect dust should be avoided.

Exclusive of any acoustical treatment and special conditions, wall surfaces should be washable, with non-porous surfaces.

## **09 21 16 Gypsum Board Assemblies**

Gypsum board finish shall be smooth wall Level IV in all areas exposed to view, and level V where subjected to critical light cast on walls and ceilings over 20 feet in length.

All gypsum board shall be 5/8" Type "X" standard, unless otherwise directed or required.



## **09 30 00 Tiling**

The Design Professional (DP) shall design and specify tile walls or tile wainscots on the wet walls of all restrooms and locker rooms unless otherwise directed by the UI PM.

The DP shall specify coved base tile in restrooms and locker rooms wherever possible.

Avoid white grout or unsealed grouting. All grouting should be pigmented and sealed as soon as possible following placement.

Any tiling used on stair treads shall have an abrasive finish or be designed to implement a 2" wide (minimum) abrasive insert that runs the entire width of the stair nosing.

## **09 50 00 Ceilings**

### **General**

Hard ceilings shall be installed in restrooms whenever possible.

Concealed grid or spline ceilings are not allowed.

### **Acoustic Tile Ceilings**

Suspended acoustical ceiling panels will typically have the following features:

- Color: White
- Natural or machine-fissured
- Square edge or Tegral edge
- 2' x 2' grid pattern or a 2' x 4' grid pattern.
- Ceiling Grid: Standard 15/16 ceiling grid. Narrow grid not allowed. (unless otherwise directed.)

## **09 60 00 Flooring**

### **Resilient Flooring and Base**

All resilient flooring shall be selected for durability and ease of maintenance. Coordinate all resilient flooring selections with the UI PM.

The use of resilient sheet flooring is discouraged in high traffic areas or areas prone to abuse.

Do not specify resilient tile floors in toilet rooms or stairways unless otherwise permitted by the UI PM.

4" rubber base is preferred. Use dark colors at rubber base to minimize visible traffic marks and scuffing. Burke #523 or Roppe 193 "Black Brown" is used predominately around campus.

### **Terrazzo Flooring**

Use of terrazzo flooring in high traffic areas is encouraged whenever the budget will support its use.

The Design Professional should attempt to re-use and/or restore existing terrazzo flooring in renovations and remodels whenever possible.

When terrazzo products are used on stair treads, provide a contrasting 2" wide abrasive strip the entire width of the stair nosing.

## **Carpeting**

All carpet should be quality material selected for durability and maintainability.

The UI prefers the use of carpet tiles whenever possible, especially in high traffic areas and classrooms. This shall be the default choice unless otherwise directed by the UI PM.

The Contractor shall submit seaming diagrams, where applicable, with the shop drawings for review and approval.

If carpet tiles are specified, the DP and UI PM shall verify the final placement and rotation patterning via a full-size field mock-up utilizing numerous full-size tiles prior to installation.

Required Extra Stock carpet tiles shall be from same manufacturer / lot / run as installed in the facility.

## **09 70 00 Wall Coverings**

### **Fabric or Vinyl Wall Coverings**

The use of fabric or vinyl wall coverings is discouraged except in limited applications where wall coverings may support the overall scheme of the building's environmental graphics, branding, and wayfinding package. Coordinate any use of wall coverings with the UI PM.

Fabric surfaces may be used as part of an acoustic / sound attenuating system.

### **Fiberglass Reinforced Panels (FRP)**

The use of FRP panels is not allowed in restrooms, offices, classrooms, corridors or any other public areas. FRP panels may be used in custodial closets, maintenance areas, and "back of house" areas of food service and/or concessions spaces.

## **09 80 00 Acoustic Treatment**

Install acoustic blanket insulation in all office, classroom, conference room, and restroom walls unless directed otherwise.

Extend walls to the underside of floor decks or roof decks in all offices, classrooms, conference rooms, and restrooms unless directed otherwise.

Extend gypsum wall board to floor or roof decks above ceiling.

Consider using a double layer of gypsum wall board on one side of each wall in offices, classrooms, and conference rooms. Coordinate with UI PM.

## **09 90 00 Painting and Coating**

### **Painting**

Incorporate the following requirements:

- Standard interior spec will be eggshell, latex-enamel.
- Do not paint exterior concrete, concrete floors, or pre-cast.

- A minimum of one (1) coat of primer and two (2) coats of finish are required on all applications.
- Use zero-VOC, water-based finishes for interior and/or onsite applications.
- Painting over fire rating tags on door frames, new or existing, is not allowed.
- Dry erase and chalk board coatings are not allowed. Install physical chalkboards, whiteboards or glass markerboards.

## Colors

The UI standard interior paint color is Campus Off-White, commonly known as “COW”. This is a special mix prepared by the local Sherwin-Williams distributor. However, COW is not a proprietary brand, and the UI can provide the mix formula for other manufacturers.

### “COW” Custom Color Mix:

<u>CCE - Colorant</u>	<u>OZ</u>	<u>32</u>	<u>64</u>	<u>128</u>
B1 – Black	-	2	-	1
R2 – Maroon	-	-	1	1
Y3 – Deep Gold	-	8	1	-

Accent colors are allowed on interior walls. The University prefers to limit the number of accent colors used in any building to three (3) or under. The entire building will then standardize around those accent colors. Coordinate with UI PM.

All bike racks shall be painted black. Equivalent powder coat color is “Black SG”.

All campus standard bollards shall be painted black. Equivalent powder coat color is “Black SG”

The UI standard paint color for exterior railings and guardrails is Sherwin-Williams 7060 “Attitude Gray”. Acceptable powder coat equivalent color is “RAL 7023 Concrete Gray”.

The UI standard paint color for the “gothic” railings used in the Historic Administration Building neighborhood is dark bronze. Powder coat color “Bronze Matte Metallic”. Verify with UI PM.

The University employs a standardized gold color for branding and accents commonly known as “Pride Gold”. That color is based on Pantone 3514C / CMYK 0-27-100-0. Equivalent paint color is Sherwin-Williams 6899 “Nasturtium”. Acceptable powder coat equivalent color is Tiger-Drylac “Buttercup 39-20130”.

*Note: Do not use SW 6899 “Nasturtium” directly next to printed or painted items base on PMS 3514C as the color match is not perfect. Use them independently or consider using a custom paint color mix to match PMS 3514C. Contractors should be aware that SW 6899 “Nasturtium” has had color variation issues between paint lots and this should be coordinated with the paint supplier ahead of painting.*

Curbs and hardscape related to universal access parking spaces shall be universal blue. All other no-parking areas such as fire lanes, fire hydrant zones, crosswalks and intersections buffers shall be denoted by a yellow curb.

All fire hydrants connected to the UI water system utility shall be powder-coated **gold**. This is a campus standard requirement to help differentiate hydrants connected to the University water system from those connected to the City of Moscow water system. The most expedient method is to ship hydrants to P&R Sandblasting in Moscow, Idaho who will sandblast and powder-coat hydrants to the UI campus standard gold color. Powder coat color is “Sahara”.

Note: All powder coat colors listed above are based on coatings and samples provided and carried by Custom Coat, Lewiston, Idaho, 208-746-4105.

# DIVISION 10 - SPECIALTIES

## **10 11 00 Visual Display Units**

The use of dry-erase paint on gypsum wall board is not allowed in lieu of marker boards.

### **Markerboards**

Markerboards shall be specified in lieu of chalkboards in offices, classrooms, meeting rooms and other areas where applicable. There are specific exceptions, especially in classrooms designated for mathematics or chemistry instruction, where chalkboards may still be required. Coordinate with the UI PM.

### **Glass Marker Boards**

Use of glass marker boards is acceptable. If multiple glass panels are used to create a larger markerboard area, the Design Professional and Contractor shall provide for higher tolerances in the straightness of the wall construction to assist with panel alignment. Or, the DP shall specify a mounting rail system that can assist with proper panel alignment.

Use steel backed marker boards for magnetic accessories. Include an accessory eraser / marker holder at all markerboard locations.

### **Portable or Rail Mounted Markerboards**

Use of portable markerboards, or semi-potable rail-mounted markerboards, is acceptable and encouraged in some applications. The DP shall coordinate use with the UI PM.

## **10 14 00 Signage**

### **Interior Signage**

#### Room Numbering:

Refer to Section 1 – Design Guidelines, “Chapter 9 – Construction Documents”, Paragraph 9.7.4 of this document for information regarding UI room numbering standards.

#### Interior Signage Standards:

New signage in remodel work shall match existing building interior signage unless the whole building is to be re-signed and/or unless otherwise directed by the UI PM.

The campus employs a standard interior room identification sign in approximately 70% of the buildings. The sign features an oak or maple border frame with a dark laminate background equal to “Gravoply II Brown 240-226” as manufactured by New Hermes Inc. The sign uses white vinyl lettering and/or tactile lettering and raised braille where required by the ADA and building codes. The UI PM or UI CAD Manager can supply details of the sign upon request from the DP.

Many of the new campus buildings, or recent major building renovations, feature premium interior sign packages that were custom designed to integrate with the building architecture. The University finds this approach acceptable. As such, there are many examples of sign types on campus that can be implemented in projects or used as a starting point for custom designed sign packages. Signs and wayfinding packages shall remain consistent and wholistic within individual buildings. Signage design and application shall be reviewed and coordinated with the UI PM.

### **Exterior Signage**

All campus exterior signage shall conform to the Campus Sign and Wayfinding Master Plan, which can be

found at the following:

<https://www.uidaho.edu/infrastructure/facilities/info-requests/forms>

The UI PM or UI CAD Manager can provide the construction drawings and details for most sign types in the Master Plan upon request from the DP.

Standard Exterior Sign Types Include:

- DR** Vehicle Directional Sign
- PW** Pedestrian Walkway Sign
- FA1** Facility / Building ID Sign, Free Standing (single name)
- FA2** Facility / Building ID Sign, Free Standing (dual names)
- FA3** Facility / Building ID Sign, Building Mounted
- PK1** Parking ID Sign, Small (for single spaces or a small range of spaces)
- PK2** Parking ID Sign, Large (for parking lot ID or entry)
- IN** Interpretive Sign
- AC** Accessible Pathway Sign
- EX1** Extension Campus, Large, Free Standing Sign
- EX2** Extension Campus, Small Storefront Sign

Standard vinyl text / graphics colors for exterior signage are as follows:

<b>BLACK:</b> 3M - BLACK 12 PANTONE BLACK C	Black 12 PANTONE® Process Black C	<b>RED:</b> 3M - TOMATO RED 13 PANTONE 1795 C	Tomato Red 13 PANTONE® 1795 C
<b>WHITE:</b> 3M - WHITE 10 PANTONE *SHALL BE REFLECTIVE	White 7125-10 and 7725-10 only	<b>BLUE:</b> 3M - INTENSE BLUE 47 PANTONE 301C	Intense Blue 47 PANTONE® 301 C
<b>GOLD:</b> 3M - SATIN GOLD 131 PANTONE 872 C	Satin Gold 131 PANTONE® 872 C	<b>PURPLE:</b> 3M - PLUM 78 PANTONE 525 C	Plum 78 PANTONE® 525 C
<b>SILVER:</b> 3M - SATIN ALUMINUM 120 PANTONE 877 C	Satin Aluminum 120 PANTONE® 877 C	<b>GREEN:</b> 3M - BRIGHT GREEN 186 PANTONE 348 C	Bright Green 186 PANTONE® 348 C
<b>PRIDE GOLD:</b> 3M - SUNFLOWER 27 PANTONE 7549 C	Sunflower 25 PANTONE® 1235 C	<b>ORANGE:</b> 3M - BRIGHT ORANGE 14 PANTONE 021 C	Bright Orange 14 PANTONE® Orange 021 C
		<b>MAGENTA:</b> 3M - PINK 64 PANTONE 214 C	Pink 64 PANTONE® 214 C

### Dedication Plaques and Date Stones:

Dedication plaques are required at all new building and major renovation / addition projects. The UI uses a standard dedication plaque layout that can be provided by the UI PM. The standard dedication plaque layout allows some flexibility for project specific elements and/or verbiage.

The use of building date markers or corner stones is highly encouraged on all new buildings or major expansions / renovations.

Examples of UI dedication plaques and date stones, both historic and recent, can be found at the following location:

<https://www.uidaho.edu/dfa/budget-and-planning/aes/campus-development-plan/history>

## **10 26 00 Wall Protection**

### **Corner Guards**

Corner guards should be used on gypsum wall board corners in all high traffic areas. The preferred corner guard is a 2x2 (nominal) stainless steel angle that extends from 4" above finish floor to a minimum of 60" above finish floor. Other options may be used to match the interior design of a specific project.

Corner guards should remain consistent throughout buildings. Match existing corner guards where applicable.

## **10 28 00 Toilet Accessories**

### **General Notes**

Carefully examine sight lines into toilet rooms.

All stainless toilet room accessories shall be specified around Bobrick unless otherwise directed. The standard finish shall be brushed satin finish.

At the principal toilet room locations for any facility, or where required by code, a third unisex, family or assisted single-stall toilet room will be provided. This requirement will be determined in consultation with the UI Project Manager and should be considered on all major capital projects and buildings to which the general public is invited.

The use of hands-free, electronic flushometers and hands-free lavatory faucets is encouraged.

### **Toilet Partitions**

Partitions may be plastic laminate, enameled steel, or phenolic.

Partitions must be anchored to the floor and be braced overhead. Provide tamper-proof fasteners and hardware at all locations.

Partitions must be provided with coat hooks.

Partitions must have self-closing hinges and ADA-compliant latch assemblies (a lever operator which does not require the use of a thumb).

### **Toilet Paper Dispensers**

Toilet paper dispensers shall be either of the following (verify with UI PM):

Georgia Pacific "Compact® Stainless Vertical Double Roll Toilet Paper Dispenser"; model number **56782**.  
Georgia Pacific "Compact 4-Roll Quad Coreless Toilet Paper Dispenser", Black; model number **56744**

Where toilet paper dispensers are mounted underneath toilet stall gab bars, coordinate mounting height to

ensure sufficient space is available to easily reach the dispenser key access and still maintain ADA mounting heights.

### **Seat Cover Dispensers**

Seat cover dispenser shall be: Bobrick “Surface Mount Seat Cover Dispenser”; model number **B-221**.

### **Towel Dispensers**

Towel dispensers shall be the following:

Georgia Pacific “Enmotion 10-inch Automated Touchless Paper Towel Dispenser”; model number **59467A**.

Some Athletic facilities and/or Auxiliary buildings may elect to use folded towel dispensers. In those cases, use the following:

Tork “H5 PeakServe Continuous Hand Towel Dispenser”; model number **552528**

### **Sanitary Napkin Dispenser**

Napkin dispensers (vending machine) shall accommodate both napkins and tampons and shall have an adjustable price setting.

Use: Bobrick “Surface Mounted Napkin/Tampon Vendor” model number **B-47069** Contura Series.

### **Sanitary Napkin Receptacles**

Napkin receptacles shall be: Bobrick “Surface Mounted Sanitary Napkin Disposal”; model number **B-270**.

### **Soap Dispensers**

Soap dispensers shall be designed for use with liquid / foam soap. They shall be wall-mounted and operate with a plunger or lever on the bottom of the unit or be a touchless, automated type sensor (verify with UI PM). Under-counter pump types shall not be used. Dispensers shall be mounted to ensure that soap drips into the wall-hung lavatory or the countertop when a self-rimming sink is used.

Dispensers may be mounted to the mirror with double-stick tape as necessary to comply with ADA requirements.

Soap dispensers shall be either of the following (verify with UI PM):

**Stoko “Refresh”** Manual Foam Dispenser. Color: Silver / Chrome.

**Georgia Pacific “Enmotion”** Gen2 Automated Touchless. Color: Black

### **Waste Receptacles**

Waste receptacles shall be: Bobrick “Floor Standing Domed Top Waste Receptacle”; model number **B-2300**.

### **Mirrors**

Mirrors shall be plate glass with stainless steel frames and shall be as large as practical.

### **Book Shelf**

Each toilet room shall be equipped with a bookshelf or integrated ledge as close as practical to the door. These may be constructed of wood, steel, stainless steel or plastic laminate as applicable. Shelves should be sufficiently sturdy to support backpacks, book bundles, etc ...

Shelves shall be designed to conform to ADA projection guidelines as applicable.

### **Coat hooks**

Each toilet room shall be equipped with a minimum of three coat hooks in addition to those in the toilet stalls. Position hooks as close as practical to the door. Coat hooks shall be anchored into blocking and able to support a backpack.

### **Grab Bars**

All universal access toilet stalls shall be provided with ADA-compliant, welded and ground, stainless steel grab bars with concealed mounting. Bobrick **Series B-6805** or equal.

### **Electric Hand Dryers**

At the principal toilet room locations in all major capital projects, or as directed by the UI Project Manager, a 208V electric hand dryer shall be provided in each toilet room. Electric hand dryers shall be Bobrick **B-748** Eclipse.

### **Baby Changing Stations**

At the principal toilet room locations in all major capital projects, or as directed by the UI Project Manager, a baby changing station shall be provided in each toilet room. Where a unisex, family/assisted toilet room has been provided, a baby changing station shall be specified in this toilet room in lieu of one each in the men's and women's toilet rooms.

Baby changing stations shall be: Koala Kare "Horizontal Recessed Stainless-Steel Baby Changing Station"; model number **KB110-SSRE**. In remodel or retrofit projects, a Koala Kare surface mount changing station may be substituted in lieu of the referenced recessed unit.

A coat hook for diaper bags shall be provided next to each baby changing station.

## **10 40 00 Safety Specialties**

### **Emergency Communications – Elevators and Areas of Rescue**

All elevators and all Areas of Rescue Assistance will be provided with ADA compliant emergency communication phones. The elevator phone will be programmed by the UI Safety Office to dial the Moscow Fire Department. The phones at the Areas of Rescue Assistance will dial only to the building fire alarm annunciator at the front door or designated fire department response location.

Communications devices installed in elevators and at Areas of Rescue Assistance shall be Talk-A-Phone Model ETP-100EB, flush mounted, ADA compliant hands-free emergency phone - distributed by Quality Elevator Products, Inc. - Chicago - 1-(800)-222-3688. This is a proprietary spec with no equal.

### **Defibrillators & Cabinets**

The DP shall verify with the UI PM if an AED defibrillator and cabinet is required in a project. Generally, at least one AED device will be required in any new building. Verify location and need for AED units with the UI Environmental Health & Safety office.

AED devices shall be: Phillips HeartStart Onsite AED; model number **M5066A**.

The AED cabinet shall be: Philips Healthcare Model **104313** Defibrillator Cabinet with standard alarm, projection wall sign, and AED decal.



## First Aid & Cabinets

First Aid cabinets and contents will be owner furnished, where required, by UI Environmental Health and Safety.

## Fire Extinguishers & Cabinets

### Fire Extinguishers

Acceptable types for installation include:

- Multi-purpose (ammonium phosphate) dry chemical types for general use areas of buildings (office/classroom areas, corridors, computer cluster sites and storage rooms). Minimum 5 lb. size. Minimum U.L. rating 2A:40BC.
- Water units for general use areas where paper or wood are the primary combustibles present. Stainless steel cylinder with rubber boot. Minimum U.L. rating 2A. **NOTE: If electrical equipment, breaker panels or flammable liquids are present, this unit is inappropriate.**
- Carbon Dioxide for use in mechanical and electrical rooms and areas where storage of flammable liquids is present (labs, warehouses, etc.). DOT 3A spun steel or aluminum cylinder with diffuser hose and horn. Manufacture date stamped in shoulder of cylinder must be within 1 year of installation. Minimum U.L. rating 20:BC.
- Regular Dry Chemical (sodium bicarbonate) for use in food preparation areas. Minimum U.L. rating 4A:60BC. **NOTE: An additional unit is required in kitchens for coverage of fires unrelated to the immediate cooking area (storage areas, electrical controls, etc.)**
- Anti-freeze - for use in unheated areas where the predominant fuel is class A (paper, textiles, grain, wood, etc.) such as barns, hay storage, cattle sheds. Minimum U.L. rating 2A. **NOTE: For unheated areas with electrical and/or flammable liquid, the addition of a Carbon Dioxide unit is recommended.**
- Approved Manufacturers: Amerex (UI has standardized equipment and parts on this brand)

### Fire Extinguisher Cabinets

- Semi-recessed cabinets with rolled edges.
- Plexi-glass or glass paneled door.
- Pressure or magnetic latch - **no key locks.**
- Door stencil "Fire Extinguisher" in red on white or white on black.
- Sized to fit required extinguisher for specific location.

### Fire Hose Racks (only when required by code)

- Pin-lock type racks with minimum 75' hose capacity.
- Baked enameled red finish steel with label "Fire Hose - For Use by Occupants".
- Satin brass or chrome finished valve - 1½" standard.
- Valves, fittings, hose and nozzle to have national standard thread.
- Nozzles to be fully adjustable fog-stream. Complete with rubber bumper and washers; lexan plastic or satin finish brass.
- Fire hose to be 1½" with rocker lug fittings. Hose to be lined, polyester-nylon with tested pressure of 250psi minimum. Lining to be rubber or synthetic blend with no seams. Test and operating pressures to be stenciled on exterior of hose. Fittings - brass or satin finish aluminum.

## 10 55 00 Mail Boxes

A designated central mail receiving room or area will be provided in each building. The mail receiving area should be a semi-secure, non-public space, and may be incorporated with other functions such as a copy or break room. The mail room must be located on the same floor as, and somewhat adjacent to, the main delivery entrance to the building. Campus Mail Services will not deliver building mail to alternate floors in the building.

In cases where it is not feasible to provide a central mail receiving room, a UI standard locked mail cabinet shall be provided near the main, ground-level entry to the building. The cabinet shall either be custom designed and fabricated as part of the project, or Owner Furnished / Owner Installed. The Design Professional shall attempt to provide dedicated space for mail cabinets in hallways or lobbies near the front entrance as applicable.

# **DIVISION 11 - EQUIPMENT**

## **11 05 00      Equipment**

### **Owner Furnished Equipment**

The University will sometimes pre-order a piece of equipment, such as a chiller, air-handler or fume hood, which may be expected to have a long delivery time. The equipment order may have to be completed prior to bidding the project for which the equipment will be installed.

The University will pay for the equipment and order it FOB job-site. The University will then advise all prospective bidders of the exact cost of the owner-furnished equipment. Immediately upon award of the contract to the successful bidder, the equipment order will be consigned to the contractor.

The contractor will be responsible for, but not limited to, the following:

- Receipt of materials including unloading, stacking and storage.
- Any freight claims for shipping damage or loss.
- Coordination with supplier in the event of mis-order or shortage.
- Assembling factory literature and instructions for O&M Manuals.
- Performing all material and labor warranty work.
- All costs related to the above items shall be included in the base bid.

In lieu of state sales tax, a Use Tax must be paid by the contractor on the value of the owner-furnished equipment. Immediately upon award of the contract, the contractor shall forward payment to the Idaho State Tax Commission in the amount of 6% of the cost of the equipment. Proof of this transaction is required by the University. The Use Tax must be included in the bid and shall not be shown as a separate line item.

Equipment delivery is anticipated within the prescribed schedule window. If an extension becomes necessary, this will be negotiated between the University and the Contractor. This Change Order will be a time extension only, and will be a no-cost change.

## **11 52 00      Audio Visual Equipment**

Refer to "Division 27 – Communications".

## **11 53 00      Laboratory Equipment**

### **Fume Hoods (Metal)**

No auxiliary air fume hoods shall be allowed.

In constant air volume situations, fume hoods shall be by-pass type.

Unless otherwise required, the face velocity of fume hoods shall be 100 feet per minute.

Fume hoods shall be properly placed in relation to doorways, main aisle ways, and supply air/exhaust air vents. Fume hood placement, capacity and airflow shall be reviewed by a qualified engineer, lab technician, or lab consultant.

## **11 12 00      Parking Control Equipment**

### **Parking Meters**

Parking meters will be owner furnished and owner installed by UI Parking and Transportation Services (UI PTS). UI PTS may elect to have the Contractor provide and install the parking meter support poles. The DP shall verify and coordinate during the Construction Document phase.

### **Pay-to-Park Meters**

Pay to Park meters and ticket devices will be owner furnished and owner installed by UI Parking and Transportation Services. The Design Professional shall verify and coordinate the location of any Pay-to-Park devices with the UI PM and UI PTS where applicable.

The DP will be expected to include in the documents, when applicable, UI standard Pay-to-Park parking signage.

### **EV Charging Stations**

Electric Vehicle (EV) Charging Stations will be owner furnished and contractor installed. EV charging station equipment is evolving, therefore the UI has not selected a standard model charging station. The UI will continue to review models and options. Charging units will be selected on the basis of capability, performance, and price point on a project-by-project basis.

The DP and the Contractor shall coordinate and verify all infrastructure and mounting requirements necessary to support owner provided EV charging equipment. EV charging station infrastructure may include:

- Parking space layout and construction
- Electrical service: buried or wall mounted
- Data service: buried or wall mounted
- Concrete foundations, piers, and/or mounting poles in parking islands
- Backing or mounting plates on building walls
- UI Standard EV charging signage

The DP shall consider the potential extra space required for a person to maneuver around and operate EV charging stations and vehicle plug-in extensions when planning parking layouts.

## **11 82 00 Facility Solid Waste Handling Equipment**

### **Solid Waste Bins**

All new and renovated facilities will be provided with a screened, grade-level, exterior concrete surface for solid waste containers and recycling bins. Solid waste dumpsters will be provided by the Owner or the local sanitation company. (Refer to “Division 32 – Exterior Improvements” for additional information.)

The UI employs a standard trash receptacle for exterior campus spaces. The trash receptacle is Model DR-1200 as manufactured by Doty & Sons Concrete Products.

- 51” wide x 26” deep x 41” high.
- Tan blend pea gravel exposed aggregate finish.
- Heavy-duty steel double hinged lid powder coated chestnut brown.
- Includes three 30-gallon rectangular, hard plastic liners.
- UI standard vinyl recycling messaging shall be applied to the lids.
- Coordinate specifications with UI PM.

### **Trash Compactors**

Buildings containing food service facilities will also be provided with a roll-off pad and related electrical service to accommodate a trash compactor of a size to be determined by the project needs. It is preferred that trash compactors be located inside a screened yard with water service and trench drains for cleaning and odor control.

Latah Sanitation, Inc and UI Recycling / Solid Waste personnel must be consulted during the programming stage for any project which will require a compactor.

### **Recycling Bins**

All new and renovated facilities will be provided with a screened exterior concrete surface for three (3) 1-yard recycling bins. This should be located next to the solid waste dumpster. (Refer to “Division 32 – Exterior Improvements” for additional information.)

Refer also to Section I – Design Guidelines; “Chapter 4 – Standard Design Elements” for information regarding interior recycling facilities.

# DIVISION 12 - FURNISHINGS

## **12 05 00 General Requirements for Furniture**

All furniture will be selected on a project by project basis.

The procurement of furnishings and other non-fixed equipment is managed by the University of Idaho Purchasing Department. UI Purchasing will source furniture through approved vendors and/or cost controlled purchasing networks available to state agencies.

Furniture is typically procured as a separate Owner package near the end of any construction project. The UI PM will coordinate furniture selection with UI Purchasing and the project Stakeholder Group. The UI PM may enlist the services of an interior design consultant to assist with furniture layout, selection, and specifications as coordinated through UI Purchasing. UI Purchasing may elect to implement an RFP process, where a specific vendor will be selected up front to assist with the process of furniture layout and selection from the full line of brands and resources available to that vendor.

On large projects or specialty design projects, the Design Professional may be contracted to supply furniture design and specifications as a Supplemental Service to the project. The UI PM will coordinate communications between the Design Professional, the Stakeholder Group and UI Purchasing.

UI Facilities and/or UI Purchasing review of all furniture selections and partition wall layouts is required prior to any purchase or installation of such furniture.

All items are to be commercial grade. No residential grade furniture.

Furniture fabrics and materials shall be selected for durability, stain resistance, and ability to be cleaned.

Select furniture patterns and colors that assist with mitigating the appearance of dirt and dust over time.

Unless otherwise specified by the UI PM, all furniture and equipment deliveries shall include “white glove service”, wherein the vendor delivers the furniture to the site and includes the following: unpacking, assembly, placement, leveling, cleaning and removal of all packing materials from campus. Disposal of boxes or packing materials in UI solid waste or recycling containers is not allowed.

The UI PM, or other specified consultant, shall be available to inspect furniture delivery and installation same day. A furniture punchlist should be produced at an on-site walk-through with the furniture vendor’s representative prior to demobilization.

### **Shelving**

Except for special circumstances, custom shelving will not be a part of the building program. However, one wall of every office, laboratory and building service room should be provided with full-height shelf standards (only) attached to each stud as a part of the project. The UI PM will review and coordinate this requirement with the DP for each project.

### **Safety**

Shelving used for chemical storage must have a lip, minimum of ½” high, installed along the front edge.

All cabinets or shelves over 72” tall must be anchored or otherwise braced to the wall. Any free-standing shelving units over 72” tall must be seismically braced as required to meet safety codes.

Furniture shall not be allowed to cover radiators, valves, environmental controls, equipment, or electrical panels. If any building systems, electrical panels and/or mechanical equipment items are blocked by

furniture, the department shall be responsible for the cost to remove and/or disassemble furniture to access equipment as required.

## **12 20 00 Window Treatments**

### **Window Films**

The installation of darkening window films to control sunlight is not allowed.

Decorative and/or graphic films may be allowed in certain applications as related to the interior building signage, environmental graphics, branding and/or wayfinding schemes. Verify with the UI PM.

### **Window Blinds**

Typical office blinds shall be 1" metal or plastic 'mini' blinds and shall generally be white, unless otherwise authorized.

Paper, fabric, or wood blinds are not allowed.

### **Window Shades**

Solar roller-shades with 10% open weaves are preferred for exterior windows, especially in classrooms or meeting rooms with video projection and/or video conferencing media systems.

Manual shade control is preferred, with a continuous bead cord. Locate cord on most convenient side for user operation. Shades may be configured as "top down" or "bottom up" as best suits individual applications.

Electric controls and motorized shades are acceptable upon review and approval of the motor and controls location and operation. Motorized shades are particularly applicable in large classrooms, lecture halls, conference rooms and other similar applications.

## **12 48 13 Entrance Mats**

### **Walk-Off Carpet / Grates**

Entry lobbies and vestibules should be designed with recessed slabs for walk-off grates (in LEED applications) or walk-off carpet. Coordinate with the UI PM.

### **Entry Mats**

Where cleanable and/or changeable entry mats are required, the mats shall be UI Standard entry mats ordered through UI Building Services. Where LEED applications require a minimum amount of walk-off area, the Design Professional will deliver that information to the UI PM to be coordinated with UI Building Services.

# DIVISION 13 - SPECIAL CONSTRUCTION

## **13 00 00    General**

The University of Idaho is the state's land grant university, enrolls over 11,000 students statewide, and is classified as a Doctoral Research Level II institution expending over \$113 million in research dollars annually. The UI has set a strategic goal to transition to a Level I Research Institution and is investing in facilities as necessary to support that goal. The UI is affiliated with the NCAA and competes at the Division-1 level across sixteen varsity sports programs. As such, the UI has numerous and varied facilities that fall under the category of "Special Construction".

A sampling of these spaces includes:

- controlled environment rooms
- clean rooms
- bio-hazard safety (BSL) rooms
- medical teaching laboratories
- magnetic resonance research
- machining and prototyping facilities
- radiation and x-ray protected rooms
- greenhouses
- grow rooms and seed germplasm facilities
- burn research laboratories
- animal husbandry, dairy, & veterinary research facilities
- cold storage rooms
- food service facilities
- specialty athletic playing surfaces
- grandstands and bleachers
- stages and performance platforms

Design Professionals working on projects related to specialized facilities shall be expected to have expertise in those areas as required for the project. The DP shall team with specialty consultants, engineers, or lab planners as necessary to bring the appropriate level of expertise to any project. In some cases, the UI may elect to partner the DP with a specialty consultant identified and selected by the University. The UI Project Manager will clearly outline these requirements during the consultant selection process and/or project development phase.

### **Hazardous Waste**

The handling of chemical, nuclear and other hazardous waste is governed by laboratory use regulations promulgated by the UI Office of Environmental Health and Safety. Acid waste piping and chemical neutralization systems will be installed where required by the Clean Water Act. However, the Safety Office shall be contacted before starting the design on any hazardous waste system.

### **Seismic Review and Modification**

Seismic review and analysis of existing structures are not addressed in the current building codes. These codes are intended for new construction where the designer, building official, and contractor have control over the structural design of the building. The strengthening of existing structures and structural modifications are limited by the economic feasibility of such work. Documents such as ATC-22, the Uniform Code for Building Conservation (UCBC) attempt to provide a minimum level of performance for existing buildings during a seismic event. This minimum level is the prevention of total collapse of the structure. If the occupants can exit the building during or after an earthquake, the building has performed as required. Because the emphasis is on preventing total collapse, the contents of the building and the building itself may not be serviceable after an earthquake. Evaluation and review should be based on this premise. Total compliance with the current building codes may not be feasible since many portions of these structures cannot meet minimum requirements of detailing and strength without significant reconstruction. Review the



lateral load resisting system with an eye towards the intended new uses and programming changes that will most likely impact the existing structural system.

Design Professionals working on remodels, additions, or renovations to any general education buildings on campus shall review the "UI General Education Building Seismic Evaluation", completed in 2012. The report outlines general seismic deficiencies for all general education building on campus, and outlines strategies for upgrades. These upgrades shall be incorporated into remodel and renovation work wherever applicable. Coordinate access to the report through the UI PM or UI CAD Manager.

### **13 11 00 Swimming Pools**

The UI maintains two NCAA competition swimming pools in the University Swim Center. The pool systems and chemical balances are tightly monitored and regulated by the Facilities Plumbing Shop. Any work in or around these pools must be strictly coordinated with the UI Plumbing Shop.

Any new swimming pools or modifications to existing pools will require secondary permitting and inspection from the North Idaho District Health Department.

### **13 12 00 Fountains**

Exterior fountains or water features are discouraged from use on campus to avoid the ongoing maintenance and vandalism issues typically experienced with these types of systems.

### **13 17 00 Therapy and Whirlpool Tubs**

Any new whirlpool tubs or therapy pools will require secondary permitting and inspection from the North Idaho District Health Department.

If therapy pools, cold-plunge pools or whirlpool tubs are for non-public use only, such as those located in restricted varsity athletics training areas, then secondary permitting and inspection is not required by the North Central District Health Department.

# DIVISION 14 - CONVEYING SYSTEMS

## **14 20 00 Elevators**

### **Design and Layout**

In all multi-level buildings and facilities, at least one passenger elevator shall serve each level, including mezzanines.

Elevators should be located as close as practical to entrances, stairways and/or logical circulation points. If possible, strategically locate elevators to encourage the use of stairways as the primary vertical circulation choice for building users.

Service elevators should be located near the service entrance or loading dock whenever possible.

Where a mechanical penthouse is located in the building, the service elevator should extend to the penthouse level. If there is only a single passenger elevator in the building, that elevator should extend to the mechanical penthouse level. Provide a secure elevator lobby at the penthouse that prevents access directly to the mechanical room or equipment. The secure lobby shall have direct access to an exit stair.

Elevator machine rooms, where required, should be located close to the elevator shaft. Machine rooms should be a minimum of 100 square feet, exclusive of the area above the hoistway (for traction elevators), and without odd corners, narrow passages or structural interferences.

### **General Provisions**

At least one elevator serving all levels of the building should be sized to accommodate an open ambulance stretcher or gurney, and identification shall be provided on the hoistway frame as compatible for that use. This requirement will be applicable even in conditions where a gurney compliant elevator is not required by code. This requirement will only be waived in elevator retrofit projects where the existing hoistway is not large enough to support a gurney compatible car enclosure.

When new elevators are installed into existing buildings where elevators do not currently exist (as opposed to an existing elevator retrofit or modernization), then the elevator design, layout and selection shall comply with the criteria for new elevators as outlined in this section.

Elevators shall have button controls to each floor without keying to shut down the unit and, if required by the program, to lock out selected floors.

To satisfy the conflicting requirements of the elevator and building codes, a fire sprinkler head shall be installed in the top of the elevator shaft in addition to the required detection devices. This sprinkler must be supplied by a pipe outside of the shaft which is controlled by a shunt-trip valve. The alarm and sprinkler devices must be serviceable through a rated access door mounted as high as possible in the side of the shaft. This access door must be provided with a suitable work platform which incorporates adjoining structures or an attached ladder and a constructed platform.

All elevators will be provided with ADA compliant emergency communication phones. The elevator phone will be programmed by the UI Safety Office to dial the Moscow Fire Department. (Refer to "Division 10 – Specialties" for additional information)

All hydraulic elevators must include an oil separator when equipped with a sump pump.

### **Service**

A local representative or service technician must be available within 30-minutes for emergency service response calls during the first year of the warranty period. This shall be outlined as a requirement in the

Design Professional's bid documents and specifications.

### **Basic Elevator Selection**

In general, elevators serving two or three floors will be Hydraulic, Machine Room-Less type. Elevators serving four or more floors will be Electric Traction type. Electric Traction type elevators may be preferred in certain buildings that are less than four floors. This is subject to review based on the specific applications and requirements of individual projects. Coordinate and verify elevator type and selection with the UI PM and UI CM.

### **Basic Elevator Specifications**

#### Passenger Elevators:

Capacity: 3500 pounds  
Cab Size: 6'-8" wide x 5'-5" deep  
Entry Size: 3'-6" wide x 7'-0" high  
Clear Head Height: 7'-6" (minimum)

#### Service Elevators:

Capacity: 5000 pounds  
Cab Size: 5'-8" wide x 9'-0" deep  
Entry Size: 4'-0" wide x 8'-0" high  
Clear Head Height: 8'-6"

#### Gurney Compliant Elevators:

Capacity: 4500 pounds (in applications where there is not a separate service elevator)  
Cab Size: 5'-8" wide x 7'-10" deep  
Entry Size: 4'-0" wide x 7'-0" high  
Clear Head Height: 8'-0"

### **Basic Elevator Performance**

Seconds from start of doors closing until doors are 3/4 open and car level and stopped at next successive floor under any loading condition or travel direction:

Passenger Elevators: 12.0 seconds (max)

Service Elevators: 15.0 seconds (max)

### **Car Enclosure**

Shell: Reinforced 14-gauge furniture steel formed panels with baked enamel interior finish as selected. Apply sound-deadening mastic to exterior.

Canopy: Reinforced 12-gauge furniture steel formed panels with lockable, contacted, hinged emergency exit.

Front Return Panels and Integral Entrance Columns: Reinforced 14-gauge furniture steel clad with minimum 16-gauge satin finish stainless steel. Swing entire unit on substantial pivot points (minimum three) for service access to car operating panels. Locate pivot points to provide full swing of front return panel without interference with side wall finish or handrail. Secure in closed position with concealed three-point latch. Provide firefighters' and service compartments with recessed flush cover and cutouts for operating switches, etc.

Transom: Reinforced 14-gauge furniture steel clad with minimum 16-gauge satin finish stainless steel full width of enclosure.

Car Door Panels: Reinforced minimum 16-gauge furniture satin finish stainless steel clad with minimum 18-gauge. Same construction as hoistway door panels. Cladding shall wrap leading and trailing edge of panel a minimum of 1/2" on rear side.

Base: Stainless steel with ventilation cutouts.

Flooring: At Passenger Elevators, provide modular carpet tiles or industrial 24"x24" rubber tile flooring. At Service Elevators, provide 3/8" aluminum diamond plate or industrial 24"x24" rubber tile flooring.

Interior Wall Finish: Floor-to-ceiling plastic laminate panels.

Ceiling: Suspended stainless steel panels.

Lighting: LED

Handrails: 1½" tubular stainless steel with 1½" standoffs on side and rear walls. Mount top of rail 35" above car floor.

Bumper Guard Rails (At Service Elevators): Solid stainless steel flat stock, 6" x 38", with 1½" standoffs 18" on center at side and rear walls. Locate center of rail 8" above car floor. Return end of rail to cab wall.

Ventilation: Two-speed exhaust blower mounted to car canopy on isolated rubber grommets. Exhaust blower shall meet noise and vibration criteria.

Protective Blankets: Provide one set of easily removable protection padding and/or blankets for temporary protection of car finishes during the remainder of construction and for the Owner to temporarily install during special moving or heavy-use operations.

### **Compliance with Regulatory Agencies**

Elevator design, installation, maintenance and inspection is under the jurisdiction of the State of Idaho Division of Building Safety (DBS). DBS conducts a statewide elevator safety program. DBS will provide plan review, permitting and inspection of all elevators. More information can be found at the following location:

<https://dbs.idaho.gov/programs/industrial/elevators/>

Comply with most stringent applicable provisions of the following codes, laws, and/or authorities, including revisions and changes in effect. The DP shall verify all applicable codes and updates with the appropriate governing authorities prior to any project.

### **Adopted Codes**

1. Safety Code for Elevators and Escalators (ANSI/ASME A17.1 2010) with the following exceptions:
  - i. Compliance with section 2.8.3.3.2 shall require that the means for disconnecting the main power as required by this section to be within sight of controller.
  - ii. Compliance with section 8.11.2.1.5(c) Car and Counterweight Buffer testing shall be conducted at slow speed in accordance with Item 5.9.2.1(a) in ANSI/ASME A17.2 2007.
  - iii. Compliance with Section 2.2.2.5, which requires a sump pump or drain in the elevator pit, shall be optional. If a sump pump or drain is installed, it shall meet the requirements of this section. A sump with a cover shall be provided in each elevator pit.
2. Guide for Inspection of Elevators, Escalators, & Moving Walks. (ANSI/ASME A17.2 2007)
3. Safety Code for Existing Elevators and Escalators. (ANSI/ASME A17.3 2008)
4. Guide for Emergency Personnel. (ANSI/ASME A17.4 1999)
5. Elevator and Escalator Electrical Equipment. (ANSI/ASME A17.5 2004)
6. Standard for Elevator Suspension, and Governor Systems. (ANSI/ASME A17.6 2010)
7. National Electrical Code, NFPA 70
8. Uniform Federal Accessibility Standard, UFAS
9. Local Fire Authority
10. Life Safety Code, NFPA101

# DIVISION 21 – FIRE SUPPRESSION

## **21 11 00 Facility Fire Suppression Water-Service Piping**

### **Campus Domestic Water System**

The campus domestic water distribution system is a separate utility owned and operated by the U of I. The Facilities Maintenance and Operations Water System Manager is the governing authority. Refer to “Division 33 – Utilities” for additional information.

U of I Facilities Maintenance and Operations has adopted the American Water Works Association (AWWA) Manual. All work on the campus water system or any backflow prevention requirements will be in accordance with the AWWA Manual.

### **Service to Building**

The building may be serviced by a single domestic water line. Once inside, the service can be split into a domestic water service, and a fire protection water service. Two reduced-pressure (RP) backflow preventers must be installed in a parallel assembly on both the domestic water and fire protection building services. (Base specification on Watts backflow preventions devices.) Each water service should be provided with an independent shut-off valve to facilitate maintenance on one system without shutting down the other. Verify requirements with UI Water Systems Manager and UI Plumbing Shop.

A dedicated room should be provided to house water service valves, backflow assemblies, fire sprinkler riser equipment, and domestic water filtration systems.

### **Fire Hydrants**

Refer to “Division 33 – Utilities”.

### **Fire Department Connections**

Coordinate the location of fire department connections with the UI PM and the Moscow Fire Department.

Fire department connections shall be easily visible, easily accessible, and with no obstructions. Coordinate site design and landscape design to provide easy access and avoid any large shrubbery or plants that will grow to obstruct visibility or access to the fire department connection.

## **21 12 00 Fire Suppression Standpipes**

### **Standpipes**

Standpipes shall conform to the following:

- Dry pipe (class I)
- Minimum size outlets 2½”.
- NST threading required.
- Wet standpipes (class II)
- All outlets provided with 1½” NST valve for hose rack connections.

## **21 13 00 Fire Suppression Sprinkler Systems**

### **General**

All areas of any new and renovated structures shall have a fire sprinkler system.

All sprinkler systems shall have an exterior bell or horn to indicate water flow alarms.

All valves, backflow preventers, post indicators and zone control valves shall have connections to the building fire alarm to monitor their open/closed status. Tamper switches shall not be connected to same monitor circuit as flow devices.

On larger or more complex projects, the Design Professional shall include a qualified fire sprinkler engineer on the project and include fire sprinkler layout drawings as part of the construction documents. Avoid using performance specifications and deferring sprinkler layout design until the shop drawing phase unless otherwise approved by the UI PM.

Fire sprinkler shop drawings must be submitted, as a deferred submittal during the construction phase, to the State of Idaho Division of Building Safety and the State of Idaho Fire Marshal's office for review and approval as part of the building permit process. The contractor and fire sprinkler sub-contractor shall be responsible for this submittal.

Any shutdowns to any portion of any fire sprinkler system will require the Contractor to give several days advance notice to the UI PM, UI CM or UI CI. Shutdowns will be coordinated with UI EHS and the local emergency services as required. Work shall be scheduled to minimize shutdown durations and impacts to existing buildings to the greatest degree possible. Where construction or remodel work may require extended shutdowns or which may impact adjacent areas that will remain occupied, then temporary accommodations and/or fire sprinkler modifications should be outlined in the Design Professional's bid documents.

Where new fire sprinkler systems are installed in existing buildings, all penetrations through floors, walls and ceilings shall be sealed or filled with approved caulking or fill materials as applicable. Minimize the size of penetrations. Penetrations in rated walls and partitions shall be sealed with an approved fire caulking or fill material which matches the required rating of the wall. Penetrations in exposed areas should be covered with an accessory escutcheon plate that completely covers the patched and sealed hole.

### **Wet Pipe Systems**

Wet pipe systems shall be the default system used on campus. Only specify dry pipe systems where piping is exposed to freezing temperatures.

Wet-pipe systems shall have an inspector's test valve with 1' piping and a ½" orifice at most remote location from control valves to simulate a single head operation.

All flow / alarm devices to initiate building fire alarm system and shall be either flow-switch or pressure-switch type.

### **Dry Pipe systems**

Dry-pipe systems to have inspectors test valve located at highest point in the system with ½" orifice and view port.

All flow alarm devices shall initiate the building fire alarm system and shall be pressure switch type.

All dry-pipe systems shall utilize an air-maintenance device in the air piping to maintain proper flow rates of air.

All dry pipe systems on the exterior of the building shall be Schedule 40 pipe unless approved otherwise.

Dry system air supply shall be furnished by dedicated air compressor properly sized for the application and mounted to the floor. Air compressors shall be UL rated, low-noise industrial units. Oilless units are not allowed.

## **Drains**

All drains shall terminate outside the building to either a drain or concrete pad.

All secondary drains shall be piped to suitable floor drain of minimum 2" pipe size. No drains shall be installed to terminate at or in a drip cup.

If it is not possible to meet the requirements above, coordinate the location of all low point drains with the UI Plumbing Shop. Low point drains should be in easy to access locations and shall feature connections to allow a drain hose to be easily connected to the low point drain.

## **21 20 00 Fire Extinguishing Systems**

Where required by code, approved local application and total flooding systems can include dry chemical, liquid suppressant (water mist systems), aqueous film forming form (AFFF), high expansion foam (HI-EX), Carbon Dioxide and other compressed gas systems.

All fire suppression systems should, during activation, initiate the building general fire alarm system for evacuation.

### **Approved manufacturers:**

- Ansul
- Kidde
- Fenwal
- Pyrotronics

## **21 30 00 Fire Pumps**

A manifold shall be supplied and routed to a suitable discharge point (storm sewer, etc.) to allow for the required performance and capacity testing without the need for additional equipment.

The manifold shall be provided with multiple 2½" discharge lines, each with isolation valve and permanently mounted pitot gauge to allow for incremental flow testing up to and including 150% rated capacity.

# DIVISION 22 – PLUMBING

## 22 00 00      General Provisions

### Domestic Water System

The campus domestic water distribution system is a separate utility owned and operated by the U of I. The Facilities Maintenance and Operations Water System Operator is the governing authority. “Refer to Division 33 – Utilities”.

U of I Facilities Maintenance and Operations has adopted the American Water Works Association (AWWA) Manual. All work on the campus water system or any backflow prevention requirements will be in accordance with the AWWA Manual.

All plumbing work must conform to the requirements of the “Idaho State Plumbing Code”, current version.

### Gas Installation Inspection

The governing authority for natural gas piping installation to UI buildings is Avista Utilities. The contractor shall coordinate all permitting, testing and inspection through the State of Idaho Division of Building Safety. The contractor shall contact Avista for service installation.

### Metering

Metering of domestic water usage is required at all buildings. Refer to “Division 33 – Utilities” for additional information.

## 22 10 00      Plumbing Piping

### Backflow Prevention

Two (2) backflow preventers must be installed in a parallel assembly on the domestic water building service. This shall be based on the degree of hazard and the type of building it serves. Some buildings, like laboratory facilities, will require both two (2) DCVA and two (2) RPVA at all main building services. All assemblies need to be parallel installations. Approved manufactures: Watts, Febco or Zurn.

Fire sprinkler systems can to be a single double check valve assembly DCVA with tamper switches - no detector checks allowed. Approved manufactures: Watts, Ames-Colt or Deringer.

All backflow assemblies shall be installed in accordance with the current USC Cross Control Manual.

### Valves

Building water services shall have a shut-off valve and road-box at the main as well as a building shut-off valve.

All valves 2" and smaller should be ball valves with stainless steel balls.

All valves must have a 600 WOG rating. Acceptable manufactures: Nibco, Watts, Apollo or equal.

All valves shall accessible. Avoid locating valves behind other utilities or ductwork that prevents visibility or maintenance access. Valves must be easily operable from a standing position or a standard step ladder. Valves above hard ceilings shall be provided within easy reach of an access door and located such that the placement of a service ladder below the access door is possible.



Buildings should be zoned by floor with sub-zoning of smaller areas as applicable. Verify plumbing zoning layout in building with the UI PM and UI Plumbing Shop during the design phase.

### **Plumbing Piping Systems**

All domestic water piping to be Type L copper at a minimum.

Drain-Waste-Vent piping to be cast iron no-hub. Any alternate materials must be approved by the UI Plumbing Shop during the design phase.

Pure Water Piping to be Low Extractable PVC specifications based on Spears manufacturing.

All acid waste systems shall be CPVC based on Spears product; manufactured to ASTM F 2618. Any alternate product must be approved by the UI Plumbing Shop in design phase.

No "constructed" fittings permitted (mitering of weld fittings, use of tee-pullers on copper mains, no soldering of trap primers to flush valve tailpiece)

Chromate plating, such as Erico or equal, is an acceptable alternate for flash copper plating on plumbing hangers and supports.

### **Floor Drains**

All floor drain traps must have an integral trap primer as per the Idaho State Plumbing Code.

Trap primers shall be supplied by one or more manifolded valve-and-timeclock assemblies wherever possible. Avoid trap primers that are supplied by any device that operates on differential pressure or flow rate. All trap primers must be electronic type equal to Precession Plumbing Products.

Floor drain traps in restrooms must be off the tail piece of the toilet flush valve when applicable. Restroom tail pieces must be the same manufacture as the flush valve.

### **Lab Water**

For biological research and other similar facilities that need for a large amount of pure water, glass washers, etc.; a complete building reverse osmosis (RO), deionized water system may be specified. Utilize laboratory-specific RO packaged systems only.

Complete building RO systems shall be based on Culligan A1 Plus RO systems. RO system design shall require pre-filtration to include a softener and a carbon tank. Systems shall also include a separate storage tank with level control as manufactured by Various Technologies.

### **Non-Potable Labels**

All lab-water and other non-potable water systems shall have warning labels affixed. These labels shall be 3/4" x 2" minimum, yellow with black lettering, self-adhering stickers with the words "Warning - Non-Potable Water."

Each faucet or other outlet must be labeled, and any other distribution system piping within a building must be labeled every 10'. In addition, one or more signs shall be mounted in highly visible locations within the lab, as close as possible to the non-potable outlets. These should be yellow signs with black lettering, approximately 6" high by 8" wide, with text as per above.

### **Pressure Vessels**

The Design Professional shall notify UI Environmental Health and Safety Office when any pressure vessel is installed. They must be added (by UI EHS) to the State inspection program.

## **Lift Stations**

All sewage and dewatering lift stations must be duplex systems and be equipped with lead/lag alternating controls to include an audio alarm located outside the building. Verify requirements with UI Plumbing Shop. Single sump pump installations must include an audio alarm to be location in a general public area.

## **22 30 00 Plumbing Equipment**

### **Domestic Water Filtration**

All new and substantially renovated buildings will have a complete building water filtration system ahead of any branch lines (except hose bibs) on the building water service.

All water filters shall be Culligan Matrix progressive with smart controllers. Softeners shall be Culligan brand models selected as applicable during the design phase.

### **Domestic Water Heaters**

Where applicable, design domestic water heating systems to use campus steam as the primary heating source. Manufacture: Aerco

Where campus steam is not available, domestic water heaters shall be gas. Use electric water heaters only in applications where steam or gas is not available, or in special applications only as approved by the UI during the design phase. Approved manufactures: Rheem, AO Smith and Bradford White

## **22 40 00 Plumbing Fixtures**

### **Custodial Room Fixtures**

Each custodial room shall have a mop sink.

Mop sinks shall be floor mounted, fiberglass units. Faucets to be Chicago model 897-RCF with integral stops (or approved equal) with vacuum breaker

Specify splash plates and/or fiberglass reinforced panel (FRP) wainscot on the walls around the sink.

### **Restroom Fixtures**

#### **General Notes:**

Hot and cold domestic water supplies to all public restrooms shall be individually isolated to allow maintenance and service work to take place without shutting down any other restrooms in the building.

Design plumbing chases to provide full maintenance access whenever possible.

Multi-fixture public restrooms on multiple building floors should be stacked whenever possible.

Use low-flow fixtures as applicable. Verify requirements with UI Plumbing Shop.

#### **Toilets:**

Select elongated white porcelain units with a white, open front seat. No lids. Toilets shall be wall-mount style with a heavy-duty carrier. Acceptable manufacturers: American Standard, Kohler or prior approved equal.

Flush valves to be Sloan Royal. Any alternate must be approved by UI Plumbing Shop supervisor.

### Urinals:

Urinals shall be washdown or blowout type. Select white porcelain units. Acceptable manufacturers: American Standard, Kohler or prior approved equal.

Flush valves to be Sloan Royal. Any alternate must be approved by UI Plumbing Shop supervisor.

The use of hands-free electronic flushometers at urinals is encouraged. If specified, these should be battery powered. Acceptable manufacturers: Sloan or Moen.

### Lavatories:

The UI prefers the use of wall hung lavatories with no countertop. Wall hung lavatories shall be white, with factory mounting brackets (no carriers).

Self-rimming countertop lavatories will be allowed in special applications and may be considered if the location of ADA compliant soap dispensers is satisfactorily resolved. Countertops shall be designed for ease of cleaning. Consider eliminating backsplashes and stopping the countertop 2" short of the tile wainscot on all sides. This prevents the build-up of soap-scum and staining in the corners of the countertop. (Tile wainscot runs continuously behind countertop.) The use of undermount lavatories may be approved with authorization from the UI PM and UI Plumbing Shop.

Faucets: Moen Commercial model 8413 with ADA approved lever handles.

The use of hands-free electronic lavatory faucets is encouraged. If specified, these should be battery powered. Preferred brand to be Chicago, model Hytronic.

### **Break Room Fixtures**

Sinks to be stainless steel; 18-gauge. Acceptable manufacturer: Elkay or equal.

Faucet to be Moen Commercial model 8125 with 8" spout; model S00500.

### **Laboratory Fixtures**

All laboratory fixtures to be manufactured by Water Saver Faucet company. All faucets to include vacuum breakers on spout. Design based on L414VB.

Pure Water faucets to be Water Saver Faucet Company design based on model L694. No vacuum breaker required.

### **Water Coolers and Bottle Fillers**

The moderate temperature of the university's water system dictates the need for refrigerated water coolers rather than drinking fountains wherever possible. Refrigerated coolers shall be a high-low, ADA-compliant pair, and shall not be fully recessed. The water service piping, drain, filters and compressor shall be accessible for servicing behind an access cover located in the front. Approved manufacturers: Elkay or Haws.

Provide water coolers with an integrated bottle filling station. Basis of design should be Elkay EZ models.

Certification of lead-free water coolers and drinking fountains is required on the product submittal. Comply with ANSI/NSF 61 standards.

Provide a durable, washable surface behind all water coolers. This surface should be more robust than painted gypsum wall board, which wears through with repeated cleaning. Consider a ceramic tile wall in water cooler alcoves. It is acceptable to add a 6" high stainless-steel backsplash behind the cooler units. Where bottle filler stations are used, the backsplash is typically only required at the lower unit that does not have the bottle filling station.

### **Emergency Eyewash Stations**

Emergency eye wash stations shall be installed in laboratories and other areas as required by code. In addition, they shall be installed where chemicals or hazardous materials may be used, such as Facilities shops and custodial closets. The Design Professional shall conduct a plan review with the UI PM and UI EHS to verify the location of all eyewash stations and to determine if eyewash stations may be required in any additional areas not necessarily required by applicable codes.

All eyewash installations must comply with ANSI/ISEA Z3581.1- 2014 standards. Approved manufacturers: Guardian or Water Saver Faucet Company. Alternate manufactures must be approved during the design phase.

Mixing valves are required on all eye wash and safety showers. Basis of design: Leonard.

All emergency stations should be installed with isolation valves with locking handles.

### **Emergency Showers**

All installations must comply with ANSI/ISEA Z3581.1- 2014 standards. Approved manufacturers: Guardian or Water Saver Faucet Company. Alternate manufactures must be approved during the design phase.

Applicable codes require a minimum flow of 20-gpm from an emergency shower. The static pressure in the UI domestic water system, combined with the required 1" supply, often results in flows exceeding 60 gpm. All emergency shower supplies must be provided with a flow restrictor with a maximum rate of 30 gpm.

### **Wall Hydrants and Hose Bibs**

Approved manufacturers: Woodford: Model 65 and Model 24

# DIVISION 23 – HEATING, VENTILATION and AIR CONDITIONING

## **23 00 00 General Provisions**

### **Central Campus Utilities**

Cooling will be by means of absorption equipment. Except for special circumstances, cooling water must be supplied from the UI campus district chiller plant locations.

Heating systems shall use steam from the central campus steam distribution system when available.

Refer to “Division 33 – Utilities” for additional information.

### **Metering**

Building metering is required for chilled water and steam condensate. These meters shall be configured to connect and communicate with both the building automation system and the SEL campus standard metering system. Refer to “Division 33 – Utilities” for additional information.

Care must be taken to locate the condensate meter to ensure full flow through the meter. Secondary metering may be required where multiple uses are anticipated, such as charge-back or for-profit operations.

### **Maintenance Accessibility**

All HVAC equipment requiring routine maintenance or servicing shall be accessible. Supply adequate clearances to completely pull filter systems or other required components for servicing or replacement.

Avoid locating valves behind other utilities or ductwork that prevents visibility or maintenance access. Valves must be easily operable from a standing position or a standard step ladder. Valves above hard ceilings shall be provided within easy reach of an access door and located such that the placement of a service ladder below the access door is possible.

All distributed VAV units and associated hydronic assemblies and components shall be located to facilitate easy access through suspended ceilings or access hatches via standard step ladders. Hydronic system low point service drains and vents shall be accessible. VAV units shall be positioned to allow adequate clearance for filter replacement and motor service as applicable.

Equipment maintenance and access clearances shall be documented and maintained as a clash layer in the Design Professional’s BIM model. The Contractor shall be required to conduct a pre-installation walk-thru or BIM review of all service equipment locations with the Owner prior to installation.

## **23 08 00 Commissioning of HVAC**

### **University Commissioning Process**

The University of Idaho, unless otherwise authorized by the UI PM, requires commissioning on all projects. The scope of the commissioning process shall be determined by the size and complexity of the project.

Refer to Section I – Design Guidelines; “Chapter 6 – Surveys, Testing & Commissioning” for detailed information on the UI Commissioning process.

### **Full System Run Test**

Following completion of the project, and immediately prior to the Substantial Completion inspection, a full building, functional performance test will be performed. This will be 96-hours in duration, and all contractors, subcontractors, factory representatives and consulting engineers will be in attendance.

### **Owner Training**

When applicable, owner training sessions will be coordinated and supervised by the Commissioning Authority. The Contractor and specified manufacturers' representatives or suppliers shall be responsible for conducting selected training sessions, providing handout information at these training sessions, and video-taping sessions as specified in the project manual and commissioning requirements.

### **Components and Systems for Commissioning**

Commissioning Certification may be required on any combination of the following components and systems:

#### Individual Components

- steam and hot water generators
- heat exchangers
- cabinet heaters and fan-coil units
- air handlers
- variable air volume boxes and terminal devices
- motorized dampers, including face-and-bypass
- motorized control valves and steam stations
- pressure reducing valves
- pumps
- humidifiers
- condensate traps
- transformers
- emergency generators

#### Interrelated Systems

- building management control systems
- variable frequency drives and starters
- acid neutralization systems
- fire alarm and detection systems
- fire sprinkler systems
- security systems
- automated electrical switching systems
- lighting controls
- elevator operation, including DLIS testing
- elevator smoke doors

### **Testing and Balancing (TAB)**

Third-party Testing and Balancing (TAB) is required on all projects unless otherwise specified by the UI PM. The qualified, third-party TAB agency will be contracted directly by the University of Idaho or by the Commissioning Agent as applicable. In many cases, qualified third-party testing and balancing may be included under the Division 23 Mechanical Contractor's scope of work. Verify methodology for each project with the UI PM and clearly outline TAB requirements in the project specifications.

Testing and Balancing shall be performed in accordance with AABC National Standards for Field Measurement and Instrumentation, Total System Balance or NEBB Procedural Standards for Testing, Balancing and Adjusting of Environmental Systems.

Testing and Balancing Agencies shall, at minimum, provide certification of membership with AABC or NEBB and a representative list of projects with at least five projects of similar size and scope to design project. All TAB agencies must be approved by the UI.

At the project closeout, the TAB Agency shall be represented at a final observation meeting by qualified testing personnel with balancing equipment and two (2) copies of air balancing test report. The UI PM or UI CM may choose and direct spot balancing of one zone. Differences of 10% or more between the spot balance and test report will be justification for repeating the testing and balancing for entire building, Rebalancing shall be done in presence of UI CM and/or Facilities HVAC Representative and subject to their

approval. Spot balance and re-balance shall be performed at no additional cost to Owner.

## **23 09 23 Direct Digital Controls for HVAC**

### **General**

Provide a management system capable of controlling and monitoring the complete mechanical system. The Building Automation System (BAS) manufacturer shall furnish a fully integrated automation system, incorporating direct digital controls (DDC) for energy management, equipment monitoring, equipment control, and subsystems.

The Building Automation Systems (within a building) shall be compatible with and completely interconnected with Campus Automation System (between buildings and/or sites). The BAS Contractor is required to furnish all parts, labor, supervision, tools, miscellaneous mounting hardware and consumables to interconnect to existing CAS System. All system components shall conform to UI standards.

The BAS manufacturer shall supervise all BAS and temperature control component / wiring installation for a complete and operable system.

The BAS system shall be designed, installed, commissioned and serviced by factory trained personnel employed by the manufacturer. The manufacturer shall have an in-place support facility within 50 miles of the site with technical staff, spare parts inventory and necessary test and diagnostic equipment. Distributors or licensed installing contractors are not acceptable. Local emergency service shall be available on a 24-hour, 7 day-a-week basis, with a normal response time from contact to arrival on site of not more than two (2) hours

#### **UI Pre-Approved Manufacturers (No substitutions):**

1. Siemens Building Technologies, Inc. BAU Division
2. Alerton BACTalk as installed by ATS Spokane Branch office

Detailed specifications can be supplied to the Design Professional upon request. Project specifications for DDC controls will not be developed and/or distributed by the Design Professional without coordination and review with the UI Facilities HVAC Shop and Utilities and Engineering Services.

Coordinate system networking with "Division 26 – Electrical" and "Division 27 – Communications" as necessary.

### **Existing Buildings**

New or expanded DDC controls in existing buildings shall be supplied by the same manufacture as the existing DDC control systems in that building.

### **Basic Network Design**

The network architecture shall consist of three levels: a campus-wide ethernet network based on TCPIIP protocol, high performance peer-to-peer building level network(s) and DDC Controller floor level local area networks with access being totally transparent to the user when accessing data or developing control programs.

The design of BAS shall allow the co-existence of new DDC Controllers with existing DDC Controllers in the same network without the use of gateways or protocol converters.

The campus has existing central operator workstations. Install /connect new buildings or systems to the existing operator workstation and ensure communications are established and graphics loaded.

### **Project Management**

The BAS manufacturer shall provide a designated project manager who will be responsible for the following:

1. Input and coordination with the GC's project schedule.
2. On-site coordination with all applicable trades, subcontractors, and vendors.
3. Authorized to accept and execute orders or instructions from owner/architect.
4. Attend project meetings as necessary to avoid conflicts and delays.
5. Make necessary field decisions relating to BAS scope of work.
6. Coordination / single point of contact.
7. Make changes to the BAS submittal documents and as-built final documents.

### **DDC System Commissioning**

Complete the 96-hour test at the completion of final commissioning and prior to substantial completion.

Pre-balance inspection and adjustment of the control systems shall be performed by the controls engineer. A written report signed by participating parties shall be forwarded to the UI PM and the Owner's Commissioning Authority (CA).

The temperature controls contractor shall assist the balancing agency as required for proper balancing of the systems. Furnish a hand-held controller or laptop service tool for the balance agency use during test and balance.

Final adjustments and calibration of systems and components, including valve and damper operators, shall be accomplished after balancing has been completed and prior to the O&M instruction period. This shall include any required setting of controls or labeling of setpoints. The temperature controls contractor shall coordinate scheduling and setpoints with the Owner's Representative. A letter of certification, stating the above has been completed and signed by the controls contractor shall be forwarded to the CA and UI PM with a copy enclosed in the O&M manual.

The CA and the UI PM shall be notified two (2) weeks in advance of scheduled time to witness sequence of operation on all systems. All systems shall be fully operational at the time of this demonstration.

### **Demonstration**

The complete and fully operational control system shall demonstrated to the designated Owner's personnel and project engineer upon completion of successful start-up and testing. Demonstration shall be an overview of the entire functionality of the system including the operator's terminal, the web browser interface, the graphical user interface, remote control point adjustment, scheduling procedures, overrides, alarms, unitary and terminal unit control.

### **Owner Training**

A minimum of two (2) separate on-site training sessions shall be provided. The first session shall be prior to substantial completion. The second training shall occur prior to the end of the first year of service. Both training sessions shall be of sufficient duration to completely cover all facets of the DDC controls operation. The DP shall verify anticipated training requirements with the UI HVAC Shop and document those requirements in the specifications.

### **Maintenance Service**

Specified maintenance service shall include, but not be limited to, a minimum of four (4) service inspections of all control systems during the first year following acceptance of the work. The inspections shall be scheduled as close as possible to the beginning of the heating and cooling seasons with the final inspection just prior to the expiration of the warranty period. These inspections are in addition to any warranty calls that are required during the warranty period. Documentation shall be forwarded to the UI PM at the completion of each trip.

### **Labeling of Equipment on Drawings**



In order to comply with UI standards for the CAS and BAS software interface, the Design Professional shall ensure that the Air Handlers and Terminal Units will be labeled and/or scheduled in the construction documents and specifications as follows:

All equipment shall be scheduled per each, no typical application shall be shown.

Naming of Air Handler Units:

Air Handling Unit No. 1 = AHU-1

Air Handling Unit No. 2 = AHU-2

etc ...

Naming of Terminal Units:

Terminal Units (TU) may also be called Variable Air Volume (VAV) boxes at the Engineer's discretion.

Terminal Units shall be assigned numbers in the order of: [number of air handler feeding unit], [floor number], and [terminal unit number]. The terminal unit number shall be assigned so that TU1 (or VAV1) is the first terminal unit off of the main supply duct on any floor. TU2 would be the second terminal unit off the supply duct on any floor, etc ...

Examples:

TU1-2-2 (or VAV1-2-2) = The second TU, located on the second floor, fed by AHU-1.

TU2-B-12 (or VAV2-B-12) = The twelfth TU, located on the basement floor, fed by AHU-2

Other Equipment Naming Standards:

AC-1	Air Conditioning Unit
AHU-1RF	Air Handler # 1 Return Fan
AHU-1SF	Air Handler # 1 Supply Fan- Fanwall 1,2,3,4,5,6,7,8, etc...
AS-1	Air Separator
C-1	Convertors
CB-A	Chilled Beams
CB-B	Chilled Beams
CRP-1	Condensate Return Pumps
CWP-1	Chilled Water Pump
DHWP-1	Domestic Hot water pumps
DXFC-1	DX Fan Coils
EF-1	Exhaust Fans
ET-1	Expansion Tank
FC-1	Fan Coils
FHET	Fume Hood Exhaust Terminal
FSD	Fire Smoke Dampers
FT-1	Flash Tank
FTR-1	Fin tube Radiation
HP-1	Air Cooled Heat Pump Unit
HRC-1	Heat Recovery Coils
HRP-1	Heat Recovery Pump
HRU-1	Heat Recovery Unit

## **23 20 00 HVAC Piping and Pumps**

### **Hydronic Piping Systems and Equipment**

Do not specify gasketed systems (Gruvloc or similar) for systems containing glycol.

Butterfly valves used on chilled water piping and heat recovery piping shall be lug type. Wafer-style butterfly valves are not allowed.

### **Steam and Condensate Piping Systems**

Campus has medium pressure distribution system (30 lbs). An entering steam station is required at all buildings. All steam components within the building must operate on 10 lbs. (Refer also to "Division 33 – Utilities")

All condensate must be pumped back to the Power Plant.

Utilize steam humidifiers.

Steam valve actuators shall be pneumatic type with analog output pneumatic transducer.

All low-pressure steam and condensate fittings, 2" and smaller, shall be 125 lbs. cast iron fittings which conform to the American Society for Testing and Materials Specification (ASTM) A126, Class B. 2½" and above shall be welded. All steam and condensate pipe will be schedule 40 black unless specified otherwise.

Grade 5 bolts will be used on all flanges. Soft (A307) bolts may not be used.

Spiral-wound metal and metal-reinforced gaskets shall be used in all flanges on steam and condensate systems.

Victaulic fittings shall not be permitted on any steam, hot water or chilled water lines.

### **Chilled Water Systems**

In terms of operating parameters, the campus chilled water loop typically runs at 45-degrees (F) and approximately 100psi. The chilled water tertiary pumps are used to prevent coils from freezing when conditions exist before draining CHW coils. Return chilled water ideally in the range of 60 – 64-degrees (F).

Victaulic fittings shall not be permitted on any steam, hot water or chilled water lines.

## **23 30 00 HVAC Air Distribution**

### **General**

The UI discourages the use of fan coil units. Fan coil units shall be used only in specific applications with limited options and only after gaining prior approval through the UI PM and UI HVAC Shop.

The permanent HVAC system should not be used for temporary or on-going heating/cooling or ventilation during construction activities. Use of the systems will only be allowed upon prior approval from the UI PM and UI CM. If the system is used prior to the coordinated and scheduled start up, then the contractor will be held accountable for cleaning air handlers, ducts etc. prior to Substantial Completion.

The mechanical systems in all rooms, but especially in any sound sensitive rooms such as classrooms and conference rooms, shall be quiet. A noise coefficient rating of NC25 is the goal. It is essential that the air handling units and/or other equipment be located on isolation slabs and/or other measures be employed as necessary to ensure that resulting building vibration is not a problem. Mechanical rooms housing air handling within the building must be designed to ensure no noise transfer to adjacent spaces.

Generally, design all storage rooms with HVAC and ventilation occupancy greater than the storage use itself would require. Often, these storage spaces are converted into office uses.

### **Air Inlets and Outlets**

Ceiling diffusers should be easily removable for cleaning purposes.

The ceiling or wall areas surrounding diffusers should be finished with washable, non-porous surfaces. If washable, non-porous ceilings are not installed, then diffusers should be skirted with a surrounding washable

collar.

The placement of the building air intakes shall include consideration of the location of exhaust air vents and fume hood exhausts, both on the building and on adjacent buildings, to prevent mixing of exhaust air with supply air. Building air intakes must be located to ensure building/equipment exhaust air (or vehicle exhaust from loading/parking areas) is not inadvertently pulled back into a building. Similarly, exhaust(s) should be placed so that exhaust air from one building is not accidentally drawn into any adjacent building.

Fume hood exhausts shall discharge 10' above the adjacent roof, a minimum of 100' from the nearest air intake, with a discharge velocity of at least 3000 feet per minute.

### **Heat Recovery**

Plan the system layout to take maximum advantage of heat recovery systems (building exhaust and fume hoods).

### **Air Handling Equipment**

All fans, blowers, air-handlers and rotating pieces of equipment will be provided with fan-inlet guards on each fan (return and supply) and belt guards as part of the contract. Specify this as a manufacturer's option. If OEM units are not available, specify custom fabricated guards.

At the time power is connected and the unit is capable of operation, the motor will be locked out and/or hasps and locks will be installed on the air-handler case. These will be UI keyed padlocks, not contractor locks. The unit will not be operated until all guards are in place.

All safeties shall be hard-wired into the fan starter circuit such that the safety shall function whether the starter selector switch is in the hand or automatic position. All safeties shall be hard wired directly to their devices and shall not rely on the DDC system software for operation.

All freeze stats shall be hard wired to the air handler associated supply and return VFD's.

Each control panel shall have an uninterrupted power supply (UPS).

### **Motors and Motor Controllers**

All non-fractional equipment motors shall be 480V, 3-phase.

Variable Frequency Drives (VFD) shall be installed on all motors rated at 5-hp and above. VFD's may be installed on selected smaller motors for specific purposes at the direction of the Design Professional.

All motors controlled by a VFD shall be rated for such compatible use and must meet the requirements of NEMA MG-1 Part 31.40.4.2.

VFD's shall be ABB only.

# DIVISION 26 – ELECTRICAL

## **26 00 00 General Provisions**

### **Electrical Utility**

The UI has utility status and maintains its own 13,200V distribution system.

All medium voltage connections (600V and under) will be completed by the contractor and that work shall be defined and included in the construction documents. All 13,200V connections will be contracted separately by the University of Idaho to one of the pre-qualified electrical contractors capable of doing that work. Refer to “Division 33 – Utilities” for additional information.

### **Related Work**

Refer to “Division 27 – Communications” and “Division 28 – Electronic Safety and Security” for additional electrical system requirements.

### **Metering**

Building metering is required for electrical usage. Refer to “Division 33 – Utilities” for additional information.

At this time, only the total service electrical usage at any building is required to be monitored. The Design Professional should look at designing the system with the flexibility to provide more detailed monitoring in the future, such as the ability to separately monitor lighting loads, plug loads, and building HVAC systems. Coordinate early in the design process with the UI PM.

Secondary meters may be required where multiple uses are anticipated, such as charge-back and/or for-profit operations.

### **Shut Downs**

All electrical service disruptions and shut downs must be coordinated in advance with the UI CM and the UI Electrical Shop. Shut downs that will impact occupied spaces, adjacent buildings, or campus neighborhoods must be coordinated at least three weeks in advance. Many buildings on campus contain on-going research that can be critically impacted by a prolonged electrical outage. The UI requires time to make alternate accommodations as may be required. All major electrical shut downs will typically be scheduled to occur early in the morning on weekends to minimize impacts to the campus.

### **Safety Program**

The UI has adopted a Hazardous Energy Control (Lock Out/Tag Out) program. A copy of the program will be provided to the contractor on each project. The contractor must comply with this program. If the contractor has their own Lock Out/Tag Out program in place, this program may be submitted to the UI for review and approval.

## **26 08 00 Commissioning of Electrical Systems**

### **University Commissioning Process**

The University of Idaho, unless otherwise authorized by the UI PM, requires commissioning on all projects. The scope of the commissioning process shall be determined by the size and complexity of the project.

Refer to Section I – Design Guidelines; “Chapter 6 – Surveys, Testing & Commissioning” for detailed information on the UI Commissioning process.

## **Owner Training**

When applicable, owner training sessions will be coordinated and supervised by the Commissioning Authority, The Contractor and specified manufacturers' representatives or suppliers shall be responsible for conducting selected training sessions, providing handout information at these training sessions, and video-taping sessions as specified in the project manual and commissioning requirements.

## **Components and Systems for Commissioning**

Commissioning Certification may be required on any combination of the following components and systems:

### Individual Components

- steam and hot water generators
- heat exchangers
- cabinet heaters and fan-coil units
- air handlers
- variable air volume boxes and terminal devices
- motorized dampers, including face-and-bypass
- motorized control valves and steam stations
- pressure reducing valves
- pumps
- humidifiers
- condensate traps
- transformers
- emergency generators

### Interrelated Systems

- building management control systems
- variable frequency drives and starters
- acid neutralization systems
- fire alarm and detection systems
- fire sprinkler systems
- security systems
- automated electrical switching systems
- lighting controls
- elevator operation, including DLIS testing
- elevator smoke doors

## **26 10 00 Electrical Service and Distribution**

### **General Guidelines**

All exterior buried conduit and ductbank enclosing circuits of 208V or greater, primary and secondary, shall be encased in concrete. Buried ductbank enclosing 13,200V circuits shall be encased in red concrete.

All circuits, including feeders and branch circuits, must include a separate ground wire.

Convenience outlets for laptops and personal device charging should be located liberally within all public spaces at reasonable locations.

Any components in mechanical and electrical rooms that require routine service and/or maintenance must be installed below 7-feet in height. The installation of any component above 7-feet requires prior review and approval from the UI PM and/or the UI Electrical Shop Supervisor.

Provide convenience outlets for custodial use at a maximum spacing of 50-feet in all corridors and hallways.

Provide a minimum of one (1) GFCI outlet in every restroom. The outlet shall be located high enough off the floor to avoid water.

Provide an electrical outlet at every stair landing.

All outlets shall be labeled with the circuit number and panel at the faceplate.

The UI utilizes pneumatic operators for all ADA automatic push button door operators. Provide a 120V circuit for a mini-compressor at each location. The compressor shall be located above a suspended ceiling or other easily accessible location within 25-feet of the door operator. The DP shall consider routing of concealed pneumatic tubing between the compressor and the door operator as part of the design. Refer to Access Control Systems in "Division 28 – Electronic Safety and Security" for additional information.

The Idaho General Safety and Health Standards may require additional ground fault protected (GFCI) outlets beyond those required by the IBC or NEC. GFCI outlets must be utilized in all exterior applications (exterior walls, roof, vaults, generator enclosures, etc). GFCI outlets must be utilized near any piece of equipment that contains, generates or dispenses water or steam (drinking fountains, safety showers and eyewashes, autoclaves, etc). Every outlet in all laboratory rooms must be a GFCI outlet.

### **Basic Materials and Methods**

Base all material specs on Square D.

### **Conduits & Raceway**

Except for light whips, the minimum conduit size shall be 3/4". 1/2" conduit may be acceptable in special circumstances, but this use will not be allowed with prior approval from the UI PM and UI Electrical Shop.

The use of MC cable is not allowed except at light whips.

The use of surface mount conduit or raceway is not allowed except in service spaces and other areas where required. Conduit shall be run inside walls in all new construction and remodels whenever possible.

Surface mount raceway may be used in exposed spaces at the direction of the UI PM. Surface raceway in public spaces shall be quality, extruded aluminum style systems with accessory matching joints, couplers, and endcaps.

### **Panelboards**

Panelboards must have 33% spare capacity.

### **Motors and Motor Controllers**

The power supply to all motors must be capable of being locked-out.

All non-fractional equipment motors shall be 480V, 3-phase.

Variable Frequency Drives (VFD) shall be installed on all motors five (5) horsepower and above. VFD's may be installed on selected smaller motors for specific purposes at the direction of the project design engineer. All motors controlled by a VFD shall be rated for use with a VFD, and must meet the requirements of NEMA MG-1 Part 31.40.4.2.

VFD's shall be ABB only.

## **26 12 00 Transformers**

### **Pad Mounted Transformers**

Building service should consist of two (2) transformers: one (1) 480/277V and one (1) 208/120V

Transformers shall be compatible with a loop feed system; “Y” configuration.

All transformers must have a 4-wire system including a grounding loop.

All transformers must have either parking bushings or feed-through bushings for the load break ells.

### **Transformer Pads**

Concrete pads for transformers shall be steel reinforced and shall be constructed as recommended by the equipment manufacturer.

The tops of concrete pads shall be plumb and level with a maximum ¼” per foot slope in all four directions to facilitate surface drainage. The concrete pad should project a maximum of 4” above finished grade. Edges of pads shall be chamfered. Provide one-foot of fine gravel sub-base below the pad.

A vault for primary, secondary, and grounding conductors shall be provided beneath the high and low voltage cable termination compartment to allow horizontal conduit entry and to permit greater freedom in handling cables. Secure the transformer to the concrete pad as recommended by the manufacturer.

### **Grounding**

The transformer station grounding shall be accomplished by installation of a #4/0 AWG bare copper grounding grid as follows:

- Drive one 5/8" x 8'-0" copper clad steel ground rod such that when the installation is complete this ground rod extends 3" above the vault floor under the high voltage compartment.
- Drive one 5/8" x 8'-0" copper clad steel ground rod similar to the above except under the low voltage compartment.
- Drive one 5/8" x 8'-0" copper clad steel ground rod at each of the four corners of the transformer pad, 6" outside the concrete pad edge to a depth such that the top of each ground rod is approximately 6" below finished grade.
- Provide a #4/0 AWG bare, stranded copper conductor connecting the corner ground rods together in a rectangular pattern approximately 6" outside the concrete pad edge. Provide another #4/0 AWG bare stranded ground conductor connecting this girdle to the ground rods under the high and low voltage cable terminating compartments. Connect the conductors to the ground rods using exothermically welded connections made at the elevation between natural earth and gravel sub-base.
- Provide a #4/0 AWG bare, stranded copper conductor to connect each of the two corners of the ground girdle that lie closest to the existing transformer pad to the existing ground grid. Connect the conductors to the existing ground rods using exothermically welded connections made at the elevation between natural earth and gravel sub-base.
- Maximum ground resistance of 10 ohms shall be provided by supplementing the grounding methods specified herein as required. Ground resistance shall be measured in normally dry conditions at least 48 hours after rainfall.

## **26 20 00 Packaged Generator Assemblies**

### **General**

Buildings should be supplied with an emergency standby generator in lieu of battery pack systems on life safety devices.

Generators will be sized to only support code-mandated egress and life safety devices as well as two receptacles in every telecommunications room as outlined in “Division 27 – Communications”. Generator

capacities will only be expanded in cases where special lab equipment, research functions or animal facilities are required to be supported by emergency power. This shall be clearly identified as part of the design scope. Verify with the UI PM.

Generators up to 150kW should operate on natural gas. Generators over 150kW will be diesel. All fuel tanks for diesel generators shall be double walled and have fuel fill / spill containment as required by local EPA regulations.

Generators shall be located in easily accessible areas with sufficient clearances for service access and testing. Generators should be located such that a service vehicle can park on hardscape within 10' – 15' of the generator. If a diesel generator is used, the accessible path must allow a fuel trailer to be parked or backed to within 15-feet of the generator.

**Preferred Manufacturers:**

Caterpillar, Cummins or Kohler. Generac is not allowed.

## **26 51 00 Interior Lighting**

**Extra Parts**

Furnish two (2) of each plastic lens type.  
Furnish two (2) of each driver type.

**Electronic Ballasts**

Base the specifications on Motorola

Manufacturer must provide minimum 2-year warranty.

**Special Applications**

Special application rooms and research laboratories are exempt from maximum code level lighting density requirements.

**Interior Lighting**

Lighting circuits shall be standard 277V.

LED Lighting is the UI standard. Provide fixtures from established lighting companies. Verify all lighting fixture selections with the UI PM and UI Electrical Shop.

Provide dimming functions wherever possible.

**Installation Considerations**

Light fixtures should not be located over toilet room fixtures or counters.

No lights should be installed over stair treads and risers. Lights should be located over landings and or wall mounted only.

Only acrylic light diffusers (if translucent) will be used. Avoid glass fixtures and lenses.

Covers should be easily removable without hitting walls, arches, etc.



## **26 56 00 Exterior Lighting**

### **Wall Packs**

Wall Packs affixed to the exterior wall are allowed only by specific permission from the UI Project Manager and Facilities Trades Director.

### **Standard Pole Mounted Head Fixture**

Lithonia: KAD LED 30C 530 40K R3 MVOLT RPUMBAK; Color: Dark Bronze DDBXB

### **UI Standard Aggregate Light Poles**

#### Manufacturer and Finish

NOV, **Ameron Centrecon Series** Poles. Exposed aggregate finish.

#### Pedestrian Scale Poles:

16'-0" (+/-) tall poles for use along pedestrian walkways and small, intimate plaza areas.

- S-Series Tapered Round Pole with Base Plate: **Model No. SBR05 - Height: 16'-5"**
- Color: 513 Brown, Natural, Exposed
- (*Note: S-series poles are more slender for pedestrian scale use.*)

#### Street Scale Poles:

25'-0" (+/-) tall poles for use along streets and drives. Sidewalks adjacent to streets may be equipped with the street scale fixture. Larger plaza areas may also be equipped with the street scale fixture.

- M-Series Tapered Round Pole with Base Plate: **Model No. MBR07.5 - Height: 24'-7"**
- Color: 513 Brown, Natural, Exposed

#### Interior Parking Lot Scale Poles:

30'-0" to 35'-0" (+/-) tall poles for use in the interior of the larger parking lots.

- M-Series Tapered Round Pole with Base Plate: **Model No. MBRX10 – Height: 32'-10"**
- Color: 513 Brown, Natural, Exposed

### **Pole Bases**

Embedded (direct bury) poles shall not be used. Poles shall be anchor base, founded on cylindrical, reinforced concrete "flagpole" type footings. Pole footings shall be engineered to withstand horizontal loading per appropriate codes.

Pole bases shall be a minimum of 24" in diameter.

Pole bases shall extend 2'-6" minimum above grade in parking areas and other areas where the pole is at risk of being struck by a vehicle.

Pole bases shall extend 6" minimum above finish grade along walks and in landscape areas where the risk of being struck by a vehicle is at a minimum.

### **Solar Pedestrian Path Pole Lighting**

The University implements solar lighting fixtures in certain areas where power is not readily available and/or it is deemed advantageous to use solar powered fixtures. The UI standard solar pole fixture is as follows:

Manufacturer: SolarOne (Fonroche Lighting)

Description: Basic Series Solar Powered Lighting System with two HL600 Lamps - SO-Bright® MPT15 Controller with Maximum Power Tracking, Run Time Extension and Remote Control Diagnostics - P130 Solar Panel with Top of Pole Mounting - Two 118 Amp Hr AGM Batteries - EL2-Pole Mounted Enclosure -Two Battery Capacity - NEMA 3R Standard, Aluminum, Vandal Resistant, Powder Coated to Match.

Fixture Model # LPB-2HL600-2MCD-MPT15-12V-P130-TP-2B118CA-EL-R5.0

Pole Model #: SO-DS340-500V160 Round Straight Steel Pole 16ft x 5" diameter

### **Historic Pole Fixtures**

Fixture: Metallic Arts Historical-Decorative Gothic with CREE; DPT Series LED Decorative Post Top Luminaire. (DPT A SB FR A 30K UL)

Pole: Hadco P-1740 - length to order 9'-8", cast aluminum with hand hole. Paint to match Metallic Arts finish.

### **Lighted Bollards**

The use of lighted bollards in individual applications on campus shall be approved by the UI PM and AES Director. Where lighted bollards are used, they shall be the following:

Pennsylvania Ave. Illuminated Bollard; Model No. BOPN-43-PM-IL. 43-inches tall. (Verify Color)  
Canterbury Designs, 5632 W. Washington Blvd., Los Angeles, CA 09916, 323-936-7111

## **26 55 00 Lighting Control Systems**

### **General System Requirements**

The lighting control system shall provide time-based, sensor-based (both occupancy and daylight), and manual lighting control.

The system shall be capable of turning lighting loads on/off as well as dimming lights (if lighting load is capable of being dimmed)

All system devices shall be networked together enabling digital communication. The system architecture shall be capable of enabling stand-alone groups (rooms) of devices to function in some default capacity even if network connectivity to the greater system is lost.

The system architecture shall facilitate remote operation via a computer connection.

The system shall have a web-based software management program that enables remote system control, status monitoring, and creation of lighting control profiles. Every device parameter (e.g. sensor time delay and photocell set-point) shall be available and configurable remotely from the software.

It is preferred that the control software have the future ability to integrate with the BAS and CAS via BACnet IP; and have the ability to enable logging of system performance data and presenting useful information in a web-based graphical format and downloadable to .CSV files.

The system shall not require any centrally hardwired switching equipment.

### **Approved Manufactures**

UI Campus Standard: **nLight** (Acuity Brands)

### **Control Devices**

Intelligent lighting control devices shall consist of one or more basic lighting control components; occupancy sensors, photocell sensors, relays, dimming outputs, manual switch stations, and manual dimming stations. Combining one or more of these components into a single device enclosure is encouraged to minimize overall device count of system.

Intelligent lighting control devices shall communicate digitally.

Occupancy sensors shall sense the presence of human activity within the desired space and fully control the on/off function of the lights. Sensors shall utilize passive infrared (PIR) technology, which detects occupant motion, to initially turn lights on. A second method of sensing is necessary to adequately detect maintained occupancy in rooms with obstructions. Provide “dual” technology sensors.

### **Control Zones**

Lighting control zones shall consist of one or more intelligent lighting control components, be capable of stand-alone operation, and be capable of being connected to a higher-level network backbone.

A lighting control zone shall be capable of automatically configuring itself for default operation without any start-up labor required.

Individual lighting zones must continue to provide a user defined default level of lighting control in the event of a system communication failure with the backbone network or the management software.

### **Access for Service**

Lighting control modules shall be grouped in a similar location within each space. The preferred location is above the door to each room.

Lighting control panels and master control modules shall be located in Electrical Rooms (first preference) or IT Closets (second preference).

Each lighting control device shall be labeled with the panel and circuit number it serves.

### **Demonstration and Training**

After the system has been completed, tested and operating properly, the manufacturer’s representative shall demonstrate by actual usage, the proper operation of each system device and function in the presence of the Owner’s Representative.

An authorized factory representative shall conduct two (2) hours minimum training for the Owner’s personnel in the operation and maintenance of the lighting controls and applicable software. Training time shall be extended as necessary to satisfy the UI PM, UI CM and Commissioning Authority (when applicable) that all pertinent topics have been adequately covered. On-site training shall follow a written training plan that is prepared in advance.

A second, smaller training session will be held with identified Facilities personnel who will be responsible for servicing of the system. This session will focus on the web-based software management and the remote access, interface and programming capabilities of the system.

Training shall be conducted by technicians who are thoroughly familiar with the specific project, the equipment and its features. The training shall include instruction, field demonstration, and over-the-shoulder hands-on exercises as necessary.

### **Spare Parts**

Powerpacks:	3% of total installed, minimum of 5 spares of each type
Occupancy sensors:	3% of total installed, minimum of 5 spares of each type
Photosensors:	3% of total installed, minimum of 5 spares of each type
Low Voltage Switches:	3% of total installed, minimum of 5 spares of each type
UL 924 Devices:	1% of total installed, minimum of 2 spares of each type

# DIVISION 27 – COMMUNICATIONS

## **27 10 00 Structured Cabling**

### **Office of Information Technology Network Team (OIT NT)**

The Office of Information Technology Services Network Team (OIT NT) is responsible for the University of Idaho's information technology infrastructure, including data networking, server hosting, classroom technology and the deployment of software to computers. The unit provides system design, system management and operational support for a wide variety of technology-based systems. OIT NT relies heavily on processes and standards to maintain an infrastructure environment that is efficient and cost-effective while also striving to maintain the security of the university's sensitive data.

### **Structured Cabling and Network Systems**

All structured cabling and network systems on campus, including those in new construction and remodel work, are furnished and installed by the Owner (UI) through OIT NT. Structured cabling systems will either be installed by qualified in-house staff through the Facilities Electrical Shop or by the certified third-party installer that is contracted directly through Information Technology Services.

OIT NT partners with a third-party contractor for all larger structured cabling installations on the UI campus. Third-party contractors are selected through a Qualifications/RPF process and work on multi-year agreements with OIT.

OIT will charge individual design and construction projects for any network design services, equipment procurement and installation costs. Costs incurred from the third-party cabling contractor will be passed through OIT to the project. The UI PM must include structured cabling design and installation costs as line items in the overall project budget.

### **UI Structured Cabling Standards (UI SCS)**

The OIT NT developed and maintains the "University of Idaho Structured Cabling Standard" (UI SCS). This document outlines all standards and requirements related to the design and installation of structured cabling systems on campus. The UI SCS also outlines requirements for the building construction and infrastructure that is required to support structured cabling and network systems. All Design Professionals (DP) and contractors working on UI projects are expected to familiarize themselves with this document.

The current edition of the UI SCS can be supplied by the UI PM or can found at the following location:

<https://www.uidaho.edu/-/media/UIdaho-Responsive/Files/oit/standards/data-security/network-connectivity/u-of-i-structured-cabling-standards.pdf>

### **Delineation of Scope**

#### **Owner Furnished Items**

In general, the following Structured Cabling components will be provided and installed though OIT NT and/or the third-party contractor:

- fiber-optic cabling and innerduct (where required)
- Cat 6 and Cat 6A cabling
- coaxial cabling
- copper cabling and/or coordination of copper cabling installation from phone utility
- termination, testing, and certification of all cabling systems
- finish faceplates and terminal ports
- wireless Access Point (WAP) devices

- switching and networking equipment
- uninterrupted power supplies (UPS)
- saddlebags or j-jooks for cabling distribution
- rack hardware and cable management components
- cable tray inside the Telecommunication Rooms

Note No. 1 – Specialized cabling required for A/V systems (balanced audio, speaker wiring, HDMI, etc.) will be part of a separate A/V package. Refer to “21 40 00 – Audio Video Systems” below.

Note No. 2 – Installation of cable tray systems outside of Telecommunications Rooms may be transferred to the General Contractor scope in cases where it makes sense to integrate cable tray scheduling and installation with other utilities and finishes during construction. Verify with UI PM and OIT NT.

#### Design Professional / General Contractor Items

In general, the following infrastructure items will be included in the Design Professional's documents and specifications for inclusion in the General Contractor's scope of work:

- ductbank, conduit, pull boxes, or pathway as required to distribute structured cabling systems
  - cable tray outside of Telecommunication Rooms
  - j-boxes and mud rings (as applicable) for face plates, cameras and wireless access points
  - poke-thru floor boxes with power where specified
  - grounding systems as outlined in the UI SCS.
  - Telecommunications Rooms (access, finishes, cooling, electrical, lighting, security, etc)
- (Note: Cable tray and equipment racks to be installed in TR's by Owner as outlined above.)

#### **OIT NT Integration with Design and Construction Projects**

All projects that require any amount of design for structured cabling systems should involve OIT NT.

Small projects that have no design requirement for structured cabling systems may be coordinated through the Facilities Electrical Shop. This applies to projects that relocate, add, or remove a limited number of IT faceplates with no changes to the network system. The Electrical Shop shall notify and coordinate work with OIT NT.

#### Planning Phase:

The UI PM will coordinate with OIT NT for a preliminary review of project requirements. This will identify if there are any non-standard design issues to be considered and establish a working outline for OIT NT's involvement in the project.

#### Design Phase:

OIT NT will, at a minimum, be required to review the 50% design documents. Additional involvement in the design phase will be coordinated at appropriate steps as required for the project scope.

Larger or more complex projects may require OIT NT to hire a third-party cabling consultant to review the design. If that is required, OIT NT will provide a cost estimate to the UI PM for review and approval.

OIT NT design phase review will coordinate basic requirements for:

- Data cabling locations
- Pathway to data locations
- Fiber backbone requirements
- Data closet quantity, size and location
- Wireless design and transmitter placement (WAPs)

The UI PM and DP shall also coordinate with the following departments for related requirements:

- OIT Classroom Technology (A/V systems)
- Campus Security Office (security cameras)
- Telephone Service (for fire alarm system and elevator emergency lines)
- OIT NT will be included on all communications with OIT CT, CSO and OIT TS teams

OIT NT will provide a design-level estimate for data cabling and network systems to the UI PM.

#### Construction Document Phase

The UI PM and the DP shall coordinate with OIT NT for a detailed review of the electrical and/or telecom drawings and specifications. OIT NT will check the documents against the detailed requirements outlined in the UI Structured Cabling Standards, to include:

- Data cabling locations (wall, floor, ceiling)
- Pathway for fiber backbone (size and location)
- Pathway to data locations (checking it exists and is large enough)
- Data closet size, location, rack layout, HVAC, electrical, lighting and security
- Wireless design and transmitter placement (WAPs)
- Door access control requirements
- HVAC, DDC controls and metering support requirements

OIT NT will provide a detailed budgetary quote for data cabling installation & equipment to the UI PM.

The quote will contain two parts:

1. Cabling installation from the third-party contractor (copper, data, fiber, racks, cable tray, etc.)
2. Networking Hardware (networking hardware, network switches, WAPs, UPS, etc.)

#### Construction Phase:

OIT NT will schedule the cabling installer based on the timeline and construction schedule provided by the UI PM and general contractor. Scheduling for cabling installation requires a minimum of two weeks advance notice.

OIT NT and the third-party structured cabling contractor will review all conduit, pathway, and boxes in the field prior to covering.

Once drywall and painting are complete, but before suspended ceiling systems are installed, OIT NT and/or the third-party structured cabling contractor will install equipment racks, cable tray and pull / terminate cabling.

OIT NT will install wired & wireless data networking equipment in the Telecommunications Rooms as soon as:

- Wall backboards are installed and painting is complete
- Flooring is installed or anti-static sealers are applied
- HVAC, electrical and grounding is operational
- Doors and locks are installed

### **Planning and Design Requirements**

The following provides a basic, abbreviated outline of the structured cabling requirements impacting the design of new construction, remodel and renovation projects. Design Professionals must review the University of Idaho Structured Cabling Standards (UI SCS) for detailed requirements.

#### Horizontal Cabling:

The Horizontal Structured Cabling System shall consist of Category 6 and Category 6 Augmented cables placed from the Telecommunications Room (TR) to distributed outlets as shown on drawings. The horizontal cable run from the TR to the Work Area Outlet (WAO) must not exceed 295 feet and contain no splices.

A 40% maximum fill-ratio must be maintained where cables enter a conduit (sleeve, stub-up, conduit run, etc.). 1" conduit is the minimum required size for structured cabling.

#### Wireless Network Infrastructure:

OIT NT does the wireless design for all spaces. For most locations, WAPs will be deployed on standard WAOs at the same height as a typical electrical outlet. In rooms with occupancy greater than 30 people, WAPs should be specified as ceiling mount with a WAO installed above the ceiling.

### Devices:

WAPs:	one (1) WAO with two (2) cat-6 cables per location
Cameras:	one (1) WAO with one (1) cat-6 cable per location
Projectors:	one (1) WAO with two (2) cat-6 cables per location
Digital Displays:	one (1) WAO with two (2) cat-6 cables per location

### Rooms:

Offices:	two (2) WAO with three (3) cat-6 cables each
Conference Rooms:	two (2) WAO with three (3) cat-6 cables each; add WAO's for devices as required
Classrooms:	two (2) WAO with three (3) cat-6 cables each; add WAO's for devices as required

### Rack Hardware:

Rack Hardware must be utilized in the Telecommunications Room (TR) on each floor to house terminated Category 6 patch panels, fiber termination hardware, and network switch equipment. Each TR contains, typically, three (3) racks with vertical and horizontal wire management. All rack hardware must be black in color and secured to the floor with appropriate hardware and overhead by cable tray. All racks will be 7 feet in height and 19 inches wide with 3-inch channels.

All rack hardware must be grounded to an approved building ground as described in TIA-942.

### Cable Tray

Main corridors shall utilize wire basket-type cable tray, minimum 18" wide and 6" deep. Any change in direction or elevation of tray must have factory-recommended hardware. If cable tray is visible, or below ceilings, verify style and placement with architectural design.

Telecommunications Rooms shall have 18" wide, ladder type cable tray. Provide a pathway into the room from corridor cable tray to rack mounted hardware. Cable tray will be mounted to walls and racks as necessary. Tray must be mounted above racks and doors. Cable trays must also act as a vertical brace for racks.

All cable trays must be grounded to an approved building ground as described in TIA-942.

### Floor / Poke-Thru Boxes (Division 26)

Floor box/poke-thru devices must be provided under table locations within conference rooms and other locations as required. These devices must include box/poke-thru and frames to allow an outlet to be placed into them. Coordinate with OIT NT to ensure plate will accept UI-selected manufacturer's connectors.

### Grounding (Division 26)

Contractor must provide a ground bar at each termination location (Telecommunications Rooms). Contractor shall provide a #6 AWG stranded copper wire cable between ground bars located at each TR and to the building main service ground point. This ground conductor must be utilized for grounding termination equipment, equipment rack and cable tray.

### Work Area Outlets (WAO)

All work area outlets must be mounted in extra deep, double gang electrical boxes. Unless specified otherwise, mount WAO outlets at same height as a typical electrical receptacle.

Where work area outlets are installed above ceilings, mount within 8" of ceiling tile.

### New Construction (Division 26)

Coax cable outlets must be double-gang outlet boxes with 1" conduit to the nearest cable tray or saddle bag system used to carry other low voltage cable that is not Category 6 data or telephone cable.

Conduit must have a pull-box after every cumulative 180-degree changes in direction. Pull-boxes must be in readily accessible locations.

No LB type fittings of any size are to be used for communication conduit

Exposed or surface-mount conduit is not allowed in new construction or remodels unless otherwise approved by the UI PM.

No PVC conduit or PVC sleeves are to be used for communications cabling.

Minimum radii for bends shall be 9 ½" for ¾" conduit, 10 ½" for 1" conduit, and the equivalent of long radius bends for larger sizes.

A nylon pull string must be run in every communication conduit prior to cable installation.

### Telecommunications Rooms

Telecommunication rooms (TR) shall house racks, voice termination fields and required cable routing hardware. Racks must be placed in a manner that must allow a minimum of 3' of clearance from the front and rear mounting surfaces. If the rack is to have electronic equipment in it, then the 3' measurement must be between the back end of the electronic device and the wall. If one mounting rail of the rack is placed against a wall, the mounting rail must be no closer than 6" to the wall to allow room for vertical management. Where there is more than one rack, the racks must be ganged with vertical management hardware to provide inter-bay management. Ganged rack frames must be placed in a manner that must allow a minimum of 3' of clearance from the front and rear mounting surfaces and on one side of the ganged assembly.

The number of Telecommunication Rooms will depend on the number of end user locations and the distance from any given location to the TR. The maximum distance between the faceplate and the TR termination is 295 feet. Generally, a TR should be provided on each floor. TRs should be stacked floor to floor if possible.

A minimum of two 4" sleeves from the communications room to the horizontal infrastructure must be installed (more as required by NEC fill requirements).

Floor Size: Minimum recommended communications room size is 8' x 10'.

Floor Surface: Non-static resilient tile flooring or two (2) coats non-static concrete floor sealer.

Ceiling Height: No ceiling is to be installed in the TR. Minimum height of 8' 6".

Door Size: 3' wide and 7' tall – swing out of room if possible.

Wall Lining (backboard): AC-grade ¾" x 4' x 8' sheets plywood, with no voids, covering all walls.

Lighting: LED light fixtures; minimum 500 lux measured at 3' above finished floor.

Power: a minimum of two (2) 20-amp, 110-volt circuits with isolated grounds shall be installed above each equipment rack, one for each rail (due to probability of no ceiling, the outlet box will need to be affixed with uni-strut - coordinate with electrical contractor). Each circuit will be on a dedicated circuit, isolated, non-switched, 4-way.

Emergency Power: If the building has an emergency generator, two (2) 20-amp, 110-volt circuits with 3-prong standards outlets shall be provided on the emergency service in each TR.

Grounding and Bonding: Install a contiguous, intra-building grounding and bonding system in compliance with TIA/EIA-607 using a minimum conductor size of 6-AWG to be located on the plywood backboard with a grounding bus bar in each TR as directed.

HVAC: Air conditioning must be provided to each TR. Maintain constant temperature of 64 - 75 F with minimum of one air change per hour. Networking/Telecommunications equipment heat dissipation is estimated at 3000 Watts per hour.  $3.7 \times 3000 = 11,100$  BTU per hour.



Fire Protection: As required by applicable codes. Both vertical and horizontal penetrations are to be fire stopped.

Equipment racks must be securely attached to the concrete floor and grounded to the grounding bus bar.

#### Fiber Optic Riser Cables

Riser cables are intra-building cables running between telecom rooms. These cables are run inside innerduct that is attached to a cable tray, J hook system or inside a separate 1" conduit connecting telecom rooms.

The facility must be equipped with a Telecommunications Bonding Backbone (TBB). This backbone must be used to ground all telecommunications cable shields, equipment, racks, cabinets, raceways, and other associated hardware that has the potential for acting as a current carrying conductor. The TBB must be installed independent of the buildings electrical and building ground and must be designed in accordance with the recommendations contained in the ANSITIA/EIA-607-A Telecommunications Bonding and Grounding Standard.

The ground bar must be no less than 3"x12" in size. Grounding conductors entering IDF's or MDF's must be no less than 4-AWG and labeled "TMGB - Do not disconnect".

## **27 41 00 Audio-Video Systems**

### **Office of Information Technology Collaboration and Classroom Technology Services**

The University of Idaho Collaboration and Classroom Technology Services (OIT CCTS) department is committed to helping plan and implement appropriate audio / video (AV) solutions and to ensure that adequate equipment, facilities and operations are available to support teaching and learning for the University of Idaho. UI collaborates with the Instructional Space Committee and the Office of the Registrar and seeks guidance from instructors to identify and implement technology solutions that meet instructional needs.

Collaboration and Classroom Technology Services (CCTS) assists with:

- Design and installation of classroom technology solutions.
- Meeting space AV solutions.

### **Audio / Video Systems Design and Procurement**

A/V equipment, when applicable, will be selected on a project-by-project basis.

In many cases, the design, selection and installation of A/V equipment will be coordinated through the UI Collaboration Classroom Technology Services (UI CCTS) team. This is often completed as a separate, owner-furnished package at the end of each project. The equipment purchase and installation will either be handled directly by the OIT CCTS team or by a third-party integrator of their choosing.

On larger projects, or projects where specialty A/V systems are required, an A/V consultant may be included as part of the Design Professional's team. If so, the CCTS team will collaborate with the consultant on consideration of OIT standards.

Under any of the scenarios above, the DP shall be expected to work through the UI PM and UI CTS to make sure that any required infrastructure to support A/V equipment is coordinated and included in the construction documents and specifications.

### **Delineation of Scope**

#### Owner Furnished Items

In general, the following A/V system components will be provided and installed through UI CTS and/or the third-party integrator:

- LCD displays and/or projection units and associated mounting hardware
- computers, touchscreens, and control systems
- A/V electronics, cameras and speaker systems
- A/V cabling (PoE Ports are provided by OIT NT)
- termination, testing, and certification of all cabling systems
- finish faceplates and terminal ports
- rack hardware and cable management components
- A/V furniture
- all use of unlicensed wireless systems must be coordinated with OIT NT

**Note No. 1** – Category 6 and/or fiber optic cabling in support of A/V systems will be furnished by OIT NT as outlined in “27 10 00 Structured Cabling” above.

**Note No. 2** – Installation of projection screens and projector mounts may be transferred to the General Contractor scope in cases where it makes sense to integrate screen installation with wall and ceiling systems. Verify with UI PM and UI CCTS.

#### Design Professional / General Contractor Items

In general, the following infrastructure items will be included in the Design Professional’s documents and specifications for inclusion in the General Contractor’s scope of work:

- Conduit, pull boxes, or pathway as required to distribute A/V systems cabling
- J-boxes and mud rings (as applicable) for face plates, cameras, displays, etc...
- Poke-thru floor boxes with power where specified
- Grounding systems as required
- Backing and blocking in walls or ceilings as required for equipment mounting
- Roller shades for daylighting control at windows in classrooms or conference rooms (Division 12)

#### Integration with Design and Construction Projects

All projects that require any level of A/V systems, including those not strictly included in classrooms or conference rooms, should include OIT Collaboration and Classroom Technology Services (UI CCTS). UI CCTS will ensure that any selected systems conform to UI equipment standards and networking requirements.

#### Planning Phase:

The UI PM will coordinate with UI CCTS for a preliminary review of project requirements. This will identify if A/V systems are required and/or if the project will have any special conditions. This will also establish a working outline for UI CCTS’s involvement in the project and identify which of the following conditions may apply:

- No A/V systems will be required.
- UI CCTS will design, procure and install A/V systems (pending available staff resources).
- The UI PM and CCTS will contract with an approved third-party integrator for design and installation.
- An A/V consultant will need to be included in the Design Professional’s team.

#### Design Phase:

UI CCTS will, at a minimum, be required to review the 50% design documents. Additional involvement in the design phase will be coordinated at appropriate steps as required for the project scope.

UI CTS design phase review will coordinate basic requirements for:

- if / where meeting space technology is required
- if / where distance learning and instruction is required
- quantity and location of displays, screens, and/or projection units
- quantity and location of teaching and/or presentation stations
- quantity and location of cameras and other related equipment
- identify where sound reinforcement may be required

#### Construction Document Phase

The DP shall coordinate with UI CCTS (and the third-party integrator when applicable) for a detailed review of the drawings and specifications to verify that necessary infrastructure is in place to support required A/V systems. Infrastructure will include:

- power for equipment, projection units, LCD displays, powered screens, etc. (Division 26)
- floor / poke thru boxes (where required) are accounted for and located correctly (Division 26)
- lighting controls integration where required (Division 26)
- conduit / pathway / j-boxes for data / network support (Division 26 and Division 27)
- conduit / pathway / j-boxes for specialty A/V cabling is located and sized correctly (Division 26)
- backing or blocking is provided for equipment mounting where required (Division 9)
- appropriate daylighting control (roller shades) is provided (Division 12)

The UI PM, UI CCTS and the DP will coordinate with the OIT Network Team for any required networking, wireless access points and structured cabling in support of A/V systems.

#### Construction Phase:

UI CCTS and/or the third-party integrator will review all conduit, pathway, boxes and wall blocking in the field prior to covering.

A/V systems equipment and cabling will typically not be installed until painting is complete, floor / wall finishes are installed, and HVAC / Electrical systems are operational. UI CCTS may request that suspended ceiling tiles not be installed until after any ceiling mounted A/V equipment and above-ceiling cabling installation is complete.

UI CCTS will be consulted for the final A/V solutions punch list.

### **Planning and Design Considerations**

The following provides a basic outline of typical A/V system installations on campus. Design Professionals will review all requirements with the UI PM and UI CCTS. Projects that go beyond the typical A/V system installations will require a third-party integrator, and the UI CCTS team will function as the agency consultant.

#### Large Classrooms and/or Lecture Halls

- Lectern with computer, document camera, touch screen control panel, wireless microphone.
- Cameras and distributed microphones as required for conferencing or distance learning.
- Distributed sound reinforcement / audio (speakers) on walls or in ceiling.
- Dual projection screens and ceiling projectors or dual large format LCD displays.
- Lighting control integration (where required).
- Assistive listening devices.
- Speech recording capability.

#### Typical Classroom

- Lectern with computer, document camera, touch screen control panel, wireless microphone.
- Cameras and microphones to support video / distance learning..
- Projection screen and ceiling projector or large format LCD displays.
- Speakers / audio on teaching wall.
- Speech recording capability.

#### Large Conference Rooms or Video Conferencing Rooms

- Touch screen control panel at table.
- Large format LCD displays at each end of room.
- Cameras and distributed microphones as required for video conferencing.
- Ceiling mounted document camera.
- Speakers / audio on walls or in ceiling.
- Power and A/V connections distributed to the conference table via floor boxes.

#### Small Conference or Team Rooms

- LCD display on one wall.

## **Projection Screens**

It is common that the CCTS team will request that projection screens, if required, be included in the DP's specifications and provided as part of the general building construction contract. (Note: projection screens are generally being phased out in favor of LCD displays.)

Screens shall be wall mounted or recessed in ceilings as applicable for individual room layouts. (Coordinate with Division 9) Projection screens shall be electric, motorized units with hard-wired controls located convenient to the teaching or presentation station. (Coordinate with Division 26)

All projection screens will not be tab-tensioned or cable-tensioned unless they are larger than 8'-0".  
Acceptable manufactures:

- Draper
- Da-Lite

# DIVISION 28 – ELECTRONIC SAFETY and SECURITY

## **28 10 00 Access Control**

### **Facilities Access Control Department (FACD)**

The Facilities Access Control Department (FACD), commonly known as the “Lock Shop”, is responsible for installation of access control systems on campus. The management, security and operational protocols are coordinated between the following departments:

- Facilities Access Control Department (FACD)
- Facilities Administration
- Environmental Health and Safety
- Campus Security Office (interface with Moscow Fire and Police Departments)
- Office of Information Technology (OIT) (Sometimes called ITS)
- Vandal Card Office

### **Access Control Software (CBORD)**

CBORD integrates with the campus-wide Vandal Card system and provides emergency lockdown capability, control of door access and the assignment of privileges. The system supports the ability to track and configure door access 24/7, integrate with surveillance systems, and allow staff to remotely manage access assignments via mobile devices and the internet.

CBORD access control systems will be furnished and installed by the UI FACD on all projects.

### **Coordination with Design Documents**

The Design Professional (DP) shall coordinate with the UI PM and the UI FACD in the development of drawings and specifications which detail the necessary components required to integrate with the owner provided control systems. The bid documents shall clearly outline door hardware and infrastructure to be provided as part of the construction contract versus scope that will be Owner Furnished and Owner Installed.

- Door hardware requirements to be coordinated with Division 8.
- Conduit, pathway, j-boxes, and power to be coordinated with Division 26.
- Bollards or pedestals (where required) to be coordinated with Division 5, Division 10 and/or Division 26.

### **Access Control Locations**

#### **Exterior**

Access control systems (card readers) are generally required at all building entrances. (Exit-only doors may be exempted.) In addition to card-swipe operation, the doors may be programmed to lock/unlock at specified hours. The UI generally requires ADA push button / auto operator systems at main building entrances. Access control functions will be required to interface with ADA operators where required.

Where individual building entrances feature multiple doors, or multiple sets of doors, only one door leaf at each entrance is required to function via the card reader and/or ADA push button.

The Campus Security Office may require that all sets of exterior doors on certain buildings have the ability to be locked down remotely and/or lock/unlock according to programmed hours. The Design Professional shall verify this requirement with the UI PM and UI FACD during the design phase. All panic bars should have the ability to be manually unlocked or “dogged” open with special tools or allen keys.

Exterior doors generally consist of hard-wired systems and the “request to exit” feature shall be integral to the door hardware crash bar.

## Interior

Interior door access control systems (card readers) will generally be located as needed for the specific design of any project. This may include departmental office suites, laboratories, specialized classrooms, training rooms, etc. The DP shall work with the UI PM and the UI Stakeholder Group to identify all required locations during the design phase.

In general, a card-swipe access should be provided at all OIT Telecommunications Rooms in the building unless otherwise authorized by the UI PM.

In general, a card swipe access should be provided at all Lactation / Mother's Rooms.

Interior doors are generally configured as wireless systems and the request to exit feature shall be programmable.

### **OIT Network Team Integration**

- All data cabling must be coordinated with OIT / ITS NT.
- PoE ports are provided by OIT / ITS NT.
- All use of unlicensed wireless must be coordinated with OIT / ITS NT
- Refer to Division 27 - Communications, "27 10 00 Structured Cabling" for additional information.

### **Exterior Door System Requirements**

(Verify all requirements with the UI FACD)  
(Refer to "Division 8 – Openings" for hardware.)

#### CBORD Controllers

The CBORD controllers, connectors, and RS485 devices are typically located in a Telecommunication Room(s). The controllers will be connected to the campus network system by the Owner. Conduits / pathway should be provided from any OIT Communication Room containing CBORD control equipment to the ADA push buttons, card reader, electric strikes / push bar and pneumatic operators at any exterior (or interior) door locations that require a hard-wired interface. Note: Each device at the door location (card reader, push buttons, pneumatic control box, strikes, etc...) must home run to the Telecommunication Room. Individual device wiring may share the same pathways where applicable, but conduit fill capacities / sizing must be verified with Owner. Verify controller locations with the FACD. It is generally easier if the wire pathways from card readers, strikes and push buttons all converge at an accessible j-box near the local pneumatic control box (when applicable), and then a common pathway is established from the local / j-box / pneumatic control box back to the Telecommunication Room. Provide conduit / pathway meeting fill capacities and sizing as required.

- |                                      |  |
|--------------------------------------|--|
| - CBORD controllers:                 | Owner Furnished and Installed                                    |
| - CBORD network connection:          | Owner Furnished and Installed                                    |
| - conduit / pathway to door devices: | include in Division 26   |
| - accessible junction box:           | include in Division 26 (and Division 8 if access doors required) |
| - interconnect wiring:               | Owner Furnished and Installed (also see below)                   |
| - networking connection:             | Owner Furnished and Installed (Division 27)                      |

#### Power Supplies

An Altronix AL1012ULXPD16 12V DC Power Supply is required to be mounted next to the CBORD control equipment in the Telecommunications Room. This will power the CBORD equipment as well as any electric door strikes or other electric locks for hard wired applications.

An additional Von Duprin PS902 24V DC Power Supply is required to power Von Duprin QEL exit devices where applicable. (QEL exit devices are not compatible with Altronix AL1012 power supply.) The VD PS 902 shall also be installed in the telecommunication room with the CBORD control equipment.

Provide a 120V electrical receptacle in the Telecom Room convenient to CBORD control equipment and power supplies.

- Altronix AL1012ULXPD16 12V DC: include in Division 8
- Von Duprin PS902 24V DC: include in Division 8 (where required)
- 120V electrical connection: include in Division 26
- conduit / pathway: include in Division 26
- interconnect wiring: Owner Furnished and Installed (also see below)

#### Access Card Reader

Card readers will be located on the exterior of the building close to the identified active door. A steel bollard or pedestal may be required where wall mounting is not feasible. The card reader will typically mount to a standard two-gang box (verify). Boxes shall be recessed in walls or bollards – avoid surface mount conduit. Card readers may be mounted on the same pedestal as the ADA push plate. Mount card readers at ADA compliant heights. Provide conduit / pathway between the card reader to the Telecommunications Room containing the CBORD control equipment and power supplies. If a local pneumatic control box is required, provide pathway to the local control box as well as the Telecommunications Room.

- Card Reader device: Owner Furnished and Installed
- recessed mounting box: include in Division 26
- conduit / pathway: include in Division 26
- interconnect wiring: Owner Furnished and Installed (also see below)
- exterior bollard (optional) Custom bollard or use LCN 8310-866FLA

#### ADA Push Plates

ADA push plates (LCN 8310-Series or equal) will be located on the exterior of the building close to the active door, inside the vestibule (where applicable) and inside the building near the active door(s). Mounting on steel bollards or posts may be required in situations where wall mounting is not feasible. Push plates will require compatible recessed mounting boxes. Mounting boxes shall be recessed in walls or bollards – avoid surface mount conduit. Exterior push plates may be mounted on the same pedestal as the card reader. All mounting locations and heights shall comply with accessible requirements (ADAAG/ANSI A117.1). Provide conduit and pathway between the ADA push plate(s) to the local pneumatic control box and to the Telecom Room containing the CBORD control equipment.

- ADA push plates: include in Division 8
- recessed mounting box: include in Division 8 or Division 26
- conduit / pathway: include in Division 26
- interconnect wiring: Owner Furnished and Installed (also see below)
- exterior bollard (optional) Custom bollard or use LCN 8310-866FLA

#### Pneumatic Auto Door Operators

Use pneumatic door operators (LCN 4822 Auto Equalizer). Provide an LCN ES7982 (where two doors are operated) or LCN ES7981 (where one door is operated) Control Box with Air Pump (compatible with LCN 4822) adjacent to each door with an auto operator. Provide a 120V circuit to power the control box / mini compressor at each location. The control box shall be located above a suspended ceiling or other accessible location within a distance to the door operator such that pneumatic tubing length does not exceed 50-feet. Compressors shall not be located above offices or conference rooms. Pneumatic tubing must be installed between the compressor and the operator. Pneumatic tubing shall be hidden in walls, ceilings and/or frame closures and shall not exceed 50-feet in length. (Coordinate during construction.) Provide conduit / pathway between control box, ADA push buttons and Telecom Room containing CBORD control equipment.

- automatic door operator: include in Division 8
- control box / mini air compressor: include in Division 8
- pneumatic tubing: include in Division 8 (LCN 925 1/4", 1/8" I.D.)
- 120V electrical connection: include in Division 26
- conduit / pathway: include in Division 26
- access panels (if required): include in Division 8
- interconnect wiring: Owner Furnished and Installed (also see below)

### Electric Panic Bar (where applicable)

An electric panic bar (Von Duprin QEL-99-NL-24VDC) is required where the active leaf is part of a pair of doors with a removable mullion. A power transfer compatible hinge (Ives 112HD-EPT) and a power transfer (Ives EPT CON) are required to route 24VDC from the power supply through the door jamb to the electric panic bar. Provide manufacture's compatible connecting harnesses (Schlage CON or equal) of required lengths inside the door. A pathway is required from the door jamb to Telecommunications Room containing the CBORD control equipment.

- electric panic bar: include in Division 8
- hinges and power transfer: include in Division 8
- door internal wiring harnesses: include in Division 8
- conduit / pathway include in Division 26
- interconnect wiring: Owner Furnished and Installed (also see below)

### Electric Strike (where applicable)

An electric strike is required at regular door jambs or non-removable mullions. (Refer to Division 8 for various electric strike applications.) Conduit and/or pathway is required between the electric strike and the Telecommunications Room containing the CBORD control equipment.

- electric strike: include in Division 8
- conduit / pathway: include in Division 26
- interconnect wiring: Owner Furnished and Installed (also see below)

### Door Position Switches

Door position switches allow the access control system to monitor for doors that are not fully latched and/or propped open. These are not required in all applications, coordinate use and requirement with the FACD. Where required, prep doors and frames as necessary. Provide pathway between all door position switches and Telecommunications Room containing the CBORD control equipment.

- position switches: include in Division 8
- conduit / pathway: include in Division 26
- interconnect wiring: Owner Furnished and Installed (also see below)

### Interconnect Wiring

Interconnect wiring to access control hardware and devices shall, in general, be provided, installed, and terminated by the Owner. At larger projects or new construction, the UI may elect to have the contractor provide and install the interconnect wiring. The Design Professional shall verify inclusion of the interconnect wiring in the drawings and specifications with the UI PM for each project. If interconnect wiring is to be included in the contract, this shall be coordinated with Division 26. In such case, the wiring shall be installed from point to point by the contractor, but all terminations and end connections shall be by the Owner (FACD).

As noted above, pathway for interconnect wiring shall be provided from each required door device (electrified strike / push bar, card reader, ADA push buttons and door position switches) to the Telecommunication Room containing the CBORD control equipment. If a local pneumatic control box is required for automatic door operators, the wiring / pathway for all door devices should converge to an accessible j-box adjacent to the control box, and then may share a common path from the j-box / control box back to the Telecommunication Room containing the CBORD control equipment. Provide conduit / pathway sized to meet wire capacities / fill requirements as required.

- card reader cable: Windy City Wire WCW 002352-S; 8-conductor #18 AWG Stranded, Foil Shield w/drain. No Stripe. Black/Red/White/Green/Brown/Blue/Orange/Yellow (By Owner or Division 26, verify)
- electric hardware cable: Windy City Wire WCW 442384-S; 4 conductor #18 AWG Stranded, no shield. Orange Stripe. Black/Red/White/Green (By Owner or Division 26, verify)



- request-to-exit (REX) cable: Windy City Wire WCW U002391-11S; 6 conductor #18 AWG Stranded, no shield. Black Stripe. Black/Red/White/Green/Brown/Blue (By Owner or Division 26, verify)
- door position switch cable: Windy City Wire WCW 444381-S; 4 conductor #22 AWG Stranded, no shield. Red Stripe. Black/Red/White/Green (By Owner or Division 26, verify)

Figure 281000-1 – Example of Access Control Layout with ADA Operators and Card Reader

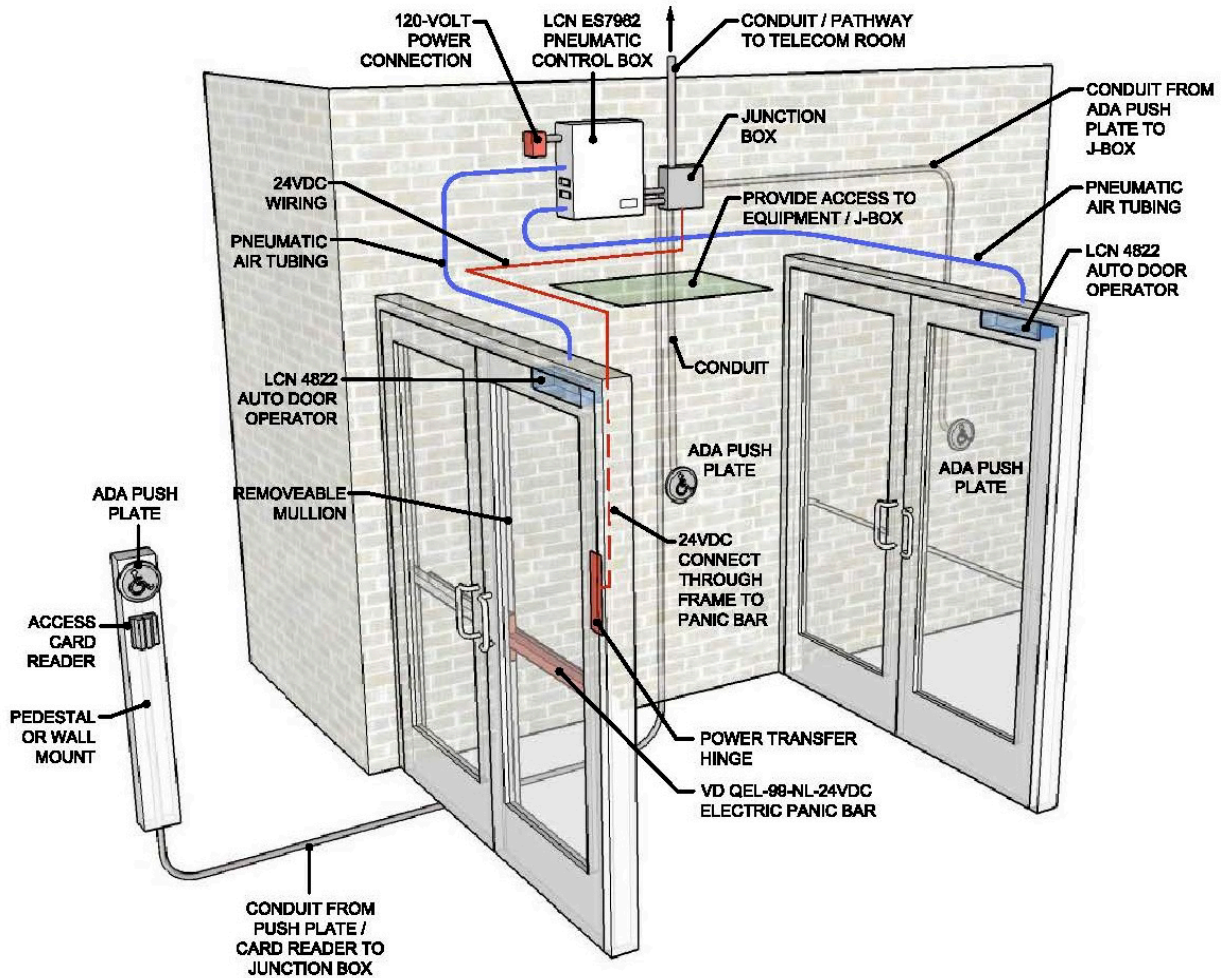
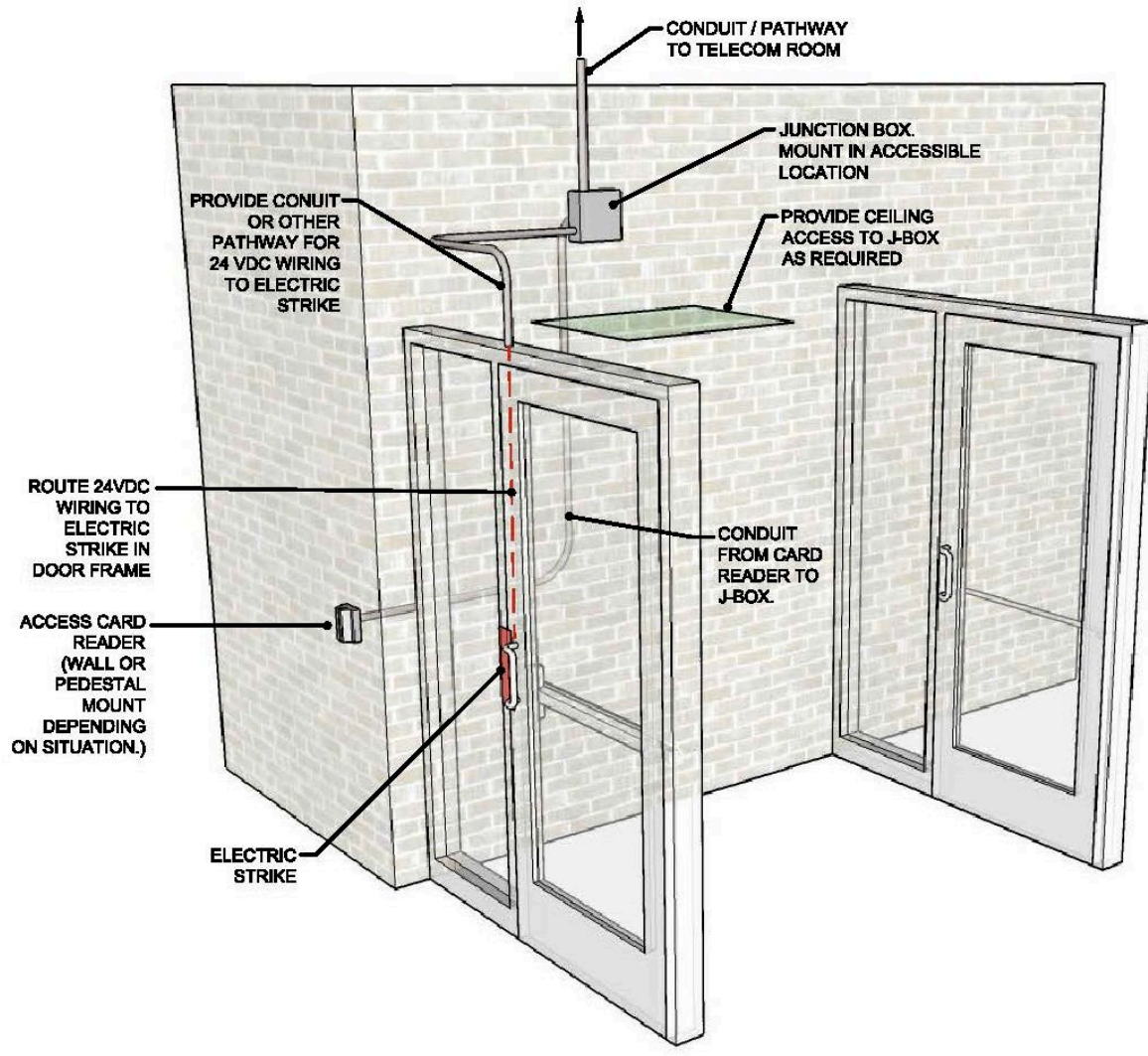

Figure 281000-2 – Example of Access Control Layout with Card Reader Only



### **Interior Door System Requirements**

#### Wireless Lockset

Access control at interior doors utilizes a battery-powered network wireless lockset (Schlage AD-400 Series). Locksets are configured for card identification compatible with Vandal Card systems. The lockset communicates wirelessly with a local Panel Interface Module (Schlage PIM 400 Series). The PIM is wired back to the CBORD control panel. Specify door prep as necessary.

- |                                  |   |
|----------------------------------|---|
| - wireless lockset:              | Owner Furnished and Installed               |
| - panel interface module (PIM):  | Owner Furnished and Installed               |
| - interconnect wiring:           | Owner Furnished and Installed               |
| - door / frame preparation       | coordinate with Division 8                  |
| - network connection / PoE ports | Owner Furnished and Installed (Division 27) |

## **28 20 00 Video Surveillance**

Video surveillance cameras shall be installed in all new buildings and/or major remodels and additions as part of the UI Campus Safety and Security Program.

### **Placement**

Cameras will be located to provide visual coverage at building entries (interior and exterior), corridors and stairwells. Other locations may be required as applicable to individual buildings.

The location of all cameras will be approved by the UI Security Office. The Design Professional and the UI PM shall schedule a coordination meeting with the UI Security Office to review the project site plan, floor plans and elevations to determine the quantity of cameras required, preferred positioning, and mounting options.

### **Coordination**

Camera devices will be furnished and installed by the Owner through UI Office of Information Technology Services. Cameras operate on the Owner's low-voltage communications infrastructure and will be connected to the campus network and programmed for operation by UI OIT / ITS and the Campus Security Office.

Camera devices require a single Cat-6 cable at each location. The camera devices operate via power-over-ethernet (POE).

Conduit, j-boxes and other special mounting plates to support camera installation and cable distribution shall be documented and provided as part of the Division 26. Each camera should have a pathway back to one of the Communication Closets as per the UI's structured cabling standards. (Refer to "Division 27 – Communications".)

### **OIT Network Team Integration**

- All data cabling must be coordinated with OIT NT.
- PoE ports are provided by OIT NT.
- All use of unlicensed wireless must be coordinated with OIT NT
- Refer to Division 27 - Communications, "27 10 00 Structured Cabling" for additional information.

## **28 46 00 Fire Detection and Alarm (Silent Knight)**

### **General**

Any work involving the shut-down or possible accidental activation of any fire alarm must be coordinated in advance with Facilities Fire Alarm and UI/EHS.

The State of Idaho has adopted the IBC/IFC. Design should be based on that code and those portions of NFPA 72 which do not conflict. Reviewed and Approved by UI Fire Alarm Technicians.

### **System Requirements**

System shall be micro-processor driven and utilize either digital or analog communication between control unit and field wired devices. All control unit functions shall be field programmable through panel mounted keypad or through RS-232c or USB connection. Software required for setup, programming, reprogramming and trouble-shooting shall be provided to UI Facilities. Panel shall be capable of auxiliary functions for testing and maintenance. Functions available to program include "Drill"; ability to disable specific HVAC smoke detection devices for maintenance; and "Test Mode", whereby audible notification appliances are disabled for device testing. All system conditions, including input, shall be annunciated through LCD output

device at control unit and remove LCD annunciator. Control Unit shall not be installed in any area where ambient temp could exceed 80o F, or where excessive humidity or dust might be present. Control unit shall incorporate an “Event Memory” and the ability to access and view each event in memory from the keypad.

Circuit zoning shall be provided to identify devices in alarm by building area. Zones shall be separated and identified by floor, area, device type and/or fire area.

HVAC smoke detection circuits shall be wired to individual zones and annunciated separately.

Auxiliary function relays shall be programmable and be internal to control cabinet to control dampers, fan shutdown, etc.

#### Digital Devices – Hochiki Protocol

Detection device address shall be capable of field changes, either through individual device or through mounting base via switch or portable programmer.

Address alarm outputs at panel shall be English descriptor, designating location by area, device, room and/or room number. Device shall be labeled to University of Idaho Standards.

Device sensitivity shall be automatically and continuously monitored and/or adjusted by control unit and identified for maintenance when sensitivity varies from listed range.

Auxiliary function relays shall be fully programmable and internal to control cabinet for control of dampers, fans, etc.

Multiple detection devices incorporating more than one type of sensing head must be calibrated to provide a higher level of influence for one type of detection in the alarm decision algorithm. This percentage of influence must be identified per device.

#### **Annunciator**

Annunciator, whether digital or analog, shall be capable of full silence and reset functions via key switches, membrane keypad or toggle switches.

All system status, alarm and trouble conditions shall be annunciated through LCD English descriptor or LED indicators. Each such indicator must be clearly labeled indicating zone or device, condition and location.

Function or key switches must be enclosed or otherwise incapable of tampering.

#### **Communicator**

Communication of all system events to the UI proprietary central station shall contact ID.

Communication device may be internal or act as a secondary panel to main control unit.

Signals sent for alarm and trouble/open circuit, shall be designated by floor or building area. All system conditions and status shall be transmitted with no delays.

#### **Equipment / Devices**

(All system materials and installation to conform to NFPA 72, UFC 1007, NEC and ADA requirements.)

#### **Smoke Detection**

Smoke detection shall never be installed in the following locations:

- in laboratory fume hood exhaust.
- in maintenance or mechanical areas.
- in attics.

- on the exterior of buildings.
- in any location where temperature may be below 40°F or above 100°F, or where high humidity, dust, insects or airborne particulates might be present.

Smoke detectors will be photo-electric.

#### Manual Pull Stations

- Manual stations shall be dual-action type, requiring operator to make two (2) distinct and separate actions to initiate alarm.
- Devices to be non-coded.

Ensure that existing safety devices (e.g., exit signs, sprinkler heads, smoke detectors, etc.) are not blocked or rendered inoperable due to renovation.

Ensure that the coverage or function of existing safety systems (e.g., sprinkler systems, smoke and heat detection systems, etc.) are not changed due to renovation.

#### Fire Alarm System Equipment

Fire Alarm Control Panel (FACP) shall be manufactured by Silent Knight (proprietary). Series 6700, 6808, 6820, 6820EVS, SD or SK protocol. Fahrenheit panels will not be excepted as substitute.

Addressable FACP: Silent Knight #5820XL or 5808-IFP 1000 or IFP 2000 depending upon battery calculations and the required battery power.

Initiating and control devices shall be manufactured, or listed as compatible, by Silent Knight – Hochiki Protocol.

Notification appliances shall be manufactured by Gentex, or System Sensor.

Relays controlling AC power circuits including, but not limited to, fire dampers, elevator controls, door holders, HVAC equipment, shall be manufactured by Air Products Controls.

Auxiliary power supplies shall be manufactured by Silent Knight.

- Conventional: Silent Knight #5499.
- Intelligent: Silent Knight #5895XL.

Remote annunciators shall be manufactured by Silent Knight.

- Addressable systems shall use Silent Knight #5860 annunciator.

#### Central Station Reporting

The contractor shall provide and install a Silent Knight digital fire-alarm communicator, including any wiring necessary to interface with FACP.

Contractor shall provide capability for fire alarm panel to report an assortment of conditions, to be determined by University of Idaho fire systems technician(s). This shall be accomplished either through the built-in capability inherent to a Silent Knight fire alarm panel, or through the use of programmable relays installed in the fire alarm control panel. These conditions shall include, but not be limited to, the following:

- System Trouble
- Sprinkler Supervisory (if sprinklers are installed) signal.
- Sprinkler Water Flow (if sprinklers are installed) alarm.
- Separate alarm condition for *each and every* floor.

Contractor must be aware that, in certain circumstances, special areas, wings, equipment, etc., will require special reporting capability. Therefore, it is essential that the owner's requirements for these conditions be determined prior to the bidding process.

#### Additional Fire Alarm System Requirements

All conductors shall be minimum size #16 AWG solid copper.

All wiring shall be installed in conduit and shall be minimum 3/4" trade size.

All single insulated conductors installed on fire alarm systems shall conform to the following color code:

- Notification appliance circuits (NAC): Red (+) and Black (-).
- Class B Alarm initiating circuits (IDC): Orange (+) and White (-).
- 24 Volt DC power circuits: Yellow (+) and Blue (-).
- Control circuits: Brown and/or Pink
- Signaling Line Circuits (SLC): Orange (+) and White (-).

Multi-conductor cables approved for use in fire alarm systems shall be utilized for remote annunciator and intelligent power supply circuits and may be substituted for single conductors on individual SLC circuits. Cable shall be Type FPL only.

System annunciator shall be located at the "front" door, pre-determined Fire Department response location, and shall be readily visible in the entrance lobby or vestibule.

Zone elevator smoke detectors separately.

Stairway fire doors, corridor doors and other doors as determined (likely to be propped open) shall have electromagnetic hold-open devices. Utilize a dedicated circuit for the hold-open devices.

Occupied buildings undergoing renovation must be provided with a sufficient temporary alarm and detection system to guarantee safe egress from the structure. This installation shall be a component of the contract. The minimum requirements shall be a pull-station at each exit, and a number of alarm devices (ADA horn/strobes) to be code-compliant. Detection devices shall be used where special circumstances dictate. All installation and wiring may be exposed and suspended in a temporary manner. The UI Environmental Health and Safety Office is the governing authority for adequacy of the temporary measures.

Contractor will be required to complete the UI Fire Alarm system closeout procedure form NFPA Record of Completion.

Fire alarm system control panels shall be connected to the normal building 120/208V power system. Do not connect these panels to the emergency power system.

Stairway fire doors, corridor doors and other doors as determined - likely to be propped open - shall have electromagnetic hold-open devices. Utilize a dedicated circuit for the hold-open devices.

Elevator smoke detectors must be a separate zone.

#### **OIT Network Team Integration**

- All data cabling must be coordinated with OIT NT.
- PoE ports are provided by OIT NT.
- All use of unlicensed wireless must be coordinated with OIT NT
- Refer to Division 27 - Communications, "27 10 00 Structured Cabling" for additional information.

# **DIVISION 31 – EARTHWORK**

## **Soils Testing & Inspection**

The UI PM, when applicable, will contract directly with a qualified third-party geotechnical engineering firm to perform soils boring and analysis of existing soil and subgrade conditions prior to the design phase. The Design Professional shall include the soils investigation report and boring log information as an appendix or supplemental information to the project specifications.

The UI PM, when applicable, will contract directly with a qualified third-party testing agency to perform Quality Assurance (QA) testing during earthwork operations. Completion of QA testing by the Owner's representative does not relieve the Contractor from responsibility for completing work and supplying materials in conformance with the plans and specifications.

The testing agency will inspect and test each subgrade and each fill or backfill layer. The contractor shall not proceed until test results verify compliance with requirements. The testing agency will examine footing subgrades prior to construction of formwork. When the testing agency reports that subgrades, fills, or backfills are below specified density and optimum moisture content, the contractor will be required to scarify and moisten or aerate, or remove and replace soil to the depth required, recompact, and retest until obtaining required density.

## **Dewatering and Erosion Control**

Construction site dewatering and erosion control systems, when required, will be provided by contractor.

Do not allow water to accumulate in excavations. Remove water to prevent softening of foundation bottoms, undercutting footings and soil changes detrimental to stability of subgrades and foundations.

The contractor will be required to monitor site erosion and dewatering systems to ensure that no sediment-laden runoff is entering into existing catch basins or into the campus stormwater drainage system. Provide sediment traps, protection and silt-fencing as required.

Dispose of water in accordance with State of Idaho water quality standards and all applicable ordinances.

## **SWPPP**

The U.S. Environmental Protection Agency (EPA) and the Idaho Department of Environmental Quality (IDEQ) requires that construction activities that disturb 1-acre or more of land, including staging areas, clearing, grading, and excavation activities; require coverage by a National Pollutant Discharge Elimination System (NPDES) stormwater permit. This is commonly known as a Storm Water Pollution and Prevention Plan (SWPPP), and it must document how the site will be configured to preclude any storm water from eroding beyond the site limits.

## **Work Restrictions**

Truck haul routes during site clearing, excavation and backfill operations shall conform with the requirements outlined in "Division 1 – General Requirements".

The contractor will be required to control dust on construction sites. The dust control plan will be developed and monitored on a project-by-project basis as coordinated with the UI Construction Manager (UI CM). Projects on the core of campus or adjacent to sensitive occupancies will require tighter restrictions.

Heavy compaction operations or installation of rammed aggregate piers (or similar) may disrupt classes, testing, or specialized research in adjacent buildings. The contractor will be required to review all compaction operations and scheduling with the UI CM prior to commencing with the work.



# DIVISION 32 – EXTERIOR IMPROVEMENTS

## **32 00 00 General**

Refer also to “Division 31 – Earthwork” and “Division 33 – Utilities” for related work.

### **Utility Locates**

Contractors must call for utility locate prior to any excavation. Many utilities on campus will be located by UI Facilities personnel, but they receive notification through the locate service for this area. The locate service is Digline (in Boise) at 1-800-342-1585 or (208) 342-1585. Digline may ask if the caller has the geographic location of the U of I. It is 39 North, Range 5 West, Section 7.

### **Soil Investigation Data**

The UI PM, when applicable, will contract directly with a qualified third-party geotechnical engineering firm to perform soils boring and analysis of existing soil and subgrade conditions prior to the design phase. The Design Professional shall include the soils investigation report and boring log information as an appendix or supplemental information to the project specifications. Refer to “Division 31 – Earthwork” for additional information.

### **Erosion Control and SWPPP**

The U.S. Environmental Protection Agency (EPA) and the Idaho Department of Environmental Quality (IDEQ) requires that construction activities that disturb 1-acre or more of land, including staging areas, clearing, grading, and excavation activities; require coverage by a National Pollutant Discharge Elimination System (NPDES) stormwater permit. Refer to “Division 31 – Earthwork” for additional information.

### **Fire Apparatus Access**

Fire apparatus access shall be maintained. When any portion of a facility is located more than 150' from an approved access route, a new access shall be provided as a part of the project. The access shall be capable of handling the imposed loads of a fire apparatus and provided with a surface that will provide all-weather driving capabilities.

The access shall have an unobstructed width of not less than 20', an unobstructed vertical clearance of not less than 13'-6", and a minimum inside radius on turns of 25'. If the access has no through outlet to a public drive, then apparatus turn-around circles or hammerheads must be provided in compliance with Moscow Fire Department requirements.

All fire access issues, regulations and requirements shall be coordinated with the Moscow Fire Department and North Idaho Deputy State Fire Marshal early in the site design process.

### **Parking**

Provide perpendicular (head on) parking and drive aisle layouts unless otherwise approved by the UI PM. Diagonal parking layouts are discouraged except in cases where site limitations will not allow perpendicular parking

Individual parking spaces will be a minimum of 9' x 18'. An additional 2' of overhang (planter or sidewalk) must be allowed. 10' x 20' parking spaces are preferred where space is available. All ADA parking spaces shall follow the requirements of the ADAAG and ANSI A117.1.

Drive aisles in parking lots shall be a minimum of 24' wide. If a drive aisle supports only one-way traffic, the width may be reduced.



If electrical vehicle (EV) charging stations are provided The DP shall consider the potential extra space required to maneuver around and operate EV charging stations and vehicle plug-in extensions.

The placement of wheel stops in parking spaces is not allowed unless otherwise directed. This is to facilitate snow clearing operations.

Snow removal shall be considered as part of any parking layout. Consider potential damage from snow pushing and piling at curbs and planters. Provide dedicated room for snow stockpiling at ends of parking rows and drive aisles. The implementation of motorcycle parking spaces is a good option for stockpile areas, as these receive limited use during snow season.

UI standard parking signage shall be installed at all new parking lots and spaces. This includes Lot ID signs, ADA signage, and specialty parking signage as applicable. Refer to Section I – Design Guidelines; “Chapter 4 – Standard Design Elements and Details”.

### **Trenching in Streets**

Where utility trenching is required in streets, work must be coordinated in advance with the UI CM and City of Moscow. Traffic control plans must be prepared as applicable. Work must be completed as quickly as possible and excavations will be topped with asphalt (at least temporary cold mix) immediately upon completion of the work. No gravel crossings will be left overnight, as per City of Moscow ordinance.

Backfill of trenches in streets and paving shall be to City of Moscow standards (i.e. no native or excavated soil; only crushed gravel). Trench backfill (structural fill) shall be compacted to 95% of maximum density as determined by ASTM D-1557 (modified proctor). Material shall be placed in maximum 10” thick loose lifts and compacted to specified density prior to starting the next lift.

## **32 12 16 Hot Mix Asphalt Paving (HMA)**

### **Base Preparation**

The subgrade surface shall be compacted to a minimum of 90 percent of the maximum dry density as determined by ASTM D-1557 (Modified Proctor). Soft or unstable areas shall be removed to firm soil and replaced with aggregate base course placed over woven geotextile fabric.

Prior to placing base course, a woven geotextile shall be placed as a separator between the subgrade and the base course. The geotextile fabric shall be non-woven fabric meeting the criteria for Type II or Type III in Section 2050, paragraph 2.3 of the ISPWC standards. Fabric shall have a minimum over-lap of 12 inches and be applied taut and free of wrinkles.

Base course shall be placed in eight-inch thick loose lifts at near optimum moisture content and compacted to at least 95 percent of ASTM D-1557 (Modified Proctor). If unsuitable bearing materials are encountered at required subgrade elevations, carry excavations deeper and replace excavated material with structural fill

Imported structural fill below asphalt pavement shall be crushed gravel conforming to requirements of ISPWC, Section 802, Crushed Aggregates, Type I (3/4” minus).

Do not place structural fill or base course material on surfaces that are muddy, frozen, or contain frost, ice or snow

### **Materials and Mix Design**

Because of the project location, with regional suppliers located in both Washington and Idaho, dual references (ITD or WSDOT) are provided.

HMA shall be composed of asphalt binder and mineral materials as required, and may include reclaimed asphalt pavement (RAP), mixed in the proportions specified to provide a homogeneous, stable, and workable

mix.

Generally, provide materials as specified in the following:

<u>Material</u>	<u>WSDOT Specification</u>	<u>ITD Specification</u>
Asphalt Binder:	9-02.1(4)	702.01
Anti-Stripping Additive:	9-02.4	702.04
Aggregates:	9-03.8	703.05
Reclaimed Asphalt Pavement (RAP):	9-03.8(3)8	720.07

### **General Mix and Batching Characteristics**

Develop the mix design in accordance with WSDOT SOP 732 or ITD AASHTO R 35. Develop a mix design that complies with WSDOT Sections 9-03 or ITD Section 405.

Mix design shall be for aggregates produced within the current calendar year. Develop a mix design with no more than 20 percent RAP.

Mix shall be based on Performance Grade (PG) asphalt binder within the follow ranges: PG58 to 64 and 22 to 28, i.e. PG64-28. Mix gradation (1/2-inch) shall fit within the tolerance bands outlined in the following:

<u>Sieve Sized % Passing</u>	<u>Percent Passing 1/2"-HMA Mix*</u>
3/4-inch	99-100
1/2-inch	90-100
3/8-inch	90 Max.
No. 4	-
No. 8	28-58
No. 200	2.0 - 7.0

\*1/2" HMA is UI Campus Standard.

### **Weather Limitations**

HMA shall not be placed on any surface with free water present, when precipitation is occurring, or when the average surface temperatures are less than 40 degrees Fahrenheit or when weather conditions otherwise prevent the proper handling or finishing of the HMA.

### **Traffic Control**

The Contractor shall control traffic in paving areas until the Contractor delineates that final compaction and surface smoothness is achieved and that pavement operations are complete. Allow paved areas to sit for a minimum of 8 hours (typically overnight) before opening streets or lots for public / vehicle use.

The Contractor is required to submit a traffic control plan to the UI PM and, when applicable, to the City of Moscow, for approval.

### **Preparing Existing Paved Surfaces**

Before placing HMA on an existing paved surface, the entire surface of the pavement shall be clean. Remove all fatty asphalt patches, grease drippings, dust, soil, grindings, and other deleterious substances from the existing pavement surface. Fill all holes and small depressions with HMA. Level and thoroughly compact the surface of patched areas.

Apply a uniform coat of asphalt (tack coat) free of streaks or bare spots to all paved surfaces on which any course of HMA is to be placed or abutted. Apply a heavy application of tack coat to all joints. Do not allow traffic on the tack coat and do not operate equipment on tacked surfaces until the tack has broken and cured.

Repair any tack coat damaged by the Contractor's operation, prior to placing HMA.

### **Spreading and Compaction**

Do not exceed 3.5 inches maximum nominal compacted depth of any layer in any course.

Immediately after the HMA has been spread and struck off, and after surface irregularities have been adjusted, the mix shall be thoroughly and uniformly compacted. The completed course shall be free from ridges, ruts, humps, depressions, objectionable marks, and irregularities and shall conform to the line, grade, and cross-section shown in the plans.

The mix shall be compacted when it is in the proper condition so that no undue displacement, cracking, or shoving occurs. Areas inaccessible to large compaction equipment shall be compacted by mechanical or hand tampers. In no case shall HMA be left uncompacted after it has cooled below proper compaction temperature. HMA that becomes loose, broken, contaminated, shows an excess or deficiency of asphalt, or is in any way defective shall be removed.

### **Testing**

The UI PM will engage a qualified third-party agency to test and inspect HMA placements. Third Party Agency test results will be the only results considered for acceptance. The Contractor shall work with the Testing Agency to secure necessary samples.

## **32 16 00 Sidewalks**

### **Curb Cuts and Ramps**

All new or replacement sidewalks will be constructed with curb cuts at street intersections, crosswalks, and other locations as appropriate in accordance with the Americans with Disabilities Act (ADAAG) and ANSI A117.1 – current edition.

Mid-block curb cuts and other curb cuts intersecting a sidewalk at 90 degrees will require an additional concrete apron and flared wing sections in line with the curb cut direction of travel and a minimum of 5' in diameter to allow a wheelchair to make the 90-degree directional transition on a hard level surface.

A tactile warning mat with raised truncated domes shall be provided at all curb ramps and crosswalks entering a street or vehicular drive aisle. Warning strips shall be the style that are poured integral with the concrete. Surface applied tactile warning strips are not allowed unless otherwise directed by the UI PM.

### **General Requirements**

Wherever possible, sidewalks shall be a minimum of 6-feet wide to accommodate compact tractor mounted snowplows. Main walkways which are expected to accommodate a significant amount of foot traffic should be 8-feet to 10-feet wide.

Unless otherwise directed, all sidewalks in campus shall be constructed to the following requirements:

- 6" thick.
- 3000# concrete.
- Reinforced with 6x6 welded wire mesh or No. 4 rebar at 16" in center each way.
- ¼" per foot maximum cross-slope.
- Standard broom finish
- A penetrating sealer applied.

All sidewalks shall have control joints at a maximum of 6-feet on center or as otherwise approved for the sidewalk layout. Control joints shall be installed at all abutments to buildings and at approximately every 20-feet in sidewalk runs.

When the budget allows, the University's preference is to specify and install hydronic snow melt systems in all exterior universal access ramps, building entrance approaches, and exterior stairs. The DP shall coordinate scope of snow melt systems with the UI PM.

Wherever possible, add diagonal sections where walks meet at right angles to match pedestrian shortcut lines.

## **32 33 00 Site Elements**

### **Standard Waste / Recycling Receptacle**

Refer to "32 33 23 - Waste and Recycling" below.

### **Exterior Signage**

Refer to "Division 10 – Specialties".

### **Bollards**

#### **Standard Fixed Bollard**

Basic Description:

- 4" or 5" fabricated steel pipe bollard
- welded steel top cap
- embedded in concrete
- painted black (standard)
- silver and gold reflective tape

(The UI PM or UI CAD Manager can provide CAD or PDF details upon request.)

#### **Standard Removable Bollard**

Basic Description:

- 4" or 5" fabricated steel pipe bollard
- welded steel top cap
- fits in steel sleeve embedded in concrete
- Through hole for pipe handle
- painted black (standard)
- silver and gold reflective tape

(The UI PM or UI CAD Manager can provide CAD or PDF details upon request.)

### **Bicycle Parking**

#### **Standard Bike Rack**

Basic Description:

- fabricated steel pipe rack
- simple hairpin design
- all bike racks to be painted black.
- space racks a minimum of 3' apart
- painted black (standard)

(The UI PM or UI CAD Manager can provide CAD or PDF details upon request.)

#### **Standard Bicycle Parking Shelter**

Standard custom fabricated small shelter that is intended primarily for covered bicycle parking. Has also been used for campus Information kiosks and other uses as applicable. The UI PM or CAD Manager can provide details at the request of the DP.

### **Standard Exterior Pole Lighting**

Refer to “Division 26 – Electrical”.

### **Banner Poles**

Banner poles have been implemented at key pedestrian walkways, vehicle calming / control areas and at other focal points on campus. Use of banner poles in site development at buildings or exterior improvements shall be coordinated with the UI Project Manager and the Director of Architectural & Engineering Services. The UI has developed a standard banner pole that features a brick base with a steel banner structure. The specific design and details can be obtained from the UI PM or UI CAD Manager.

There are two standard banner pole heights (refer also to Figure 323300-1 below):

- Short Banner Pole: 14'-5" tall. To be used in pedestrian only zones.
- Tall Banner Pole: 22'-2" tall. To be used in sidewalks or planters adjacent to vehicular roadways.

*Figure 323300-1 – Standard Banner Pole Heights*

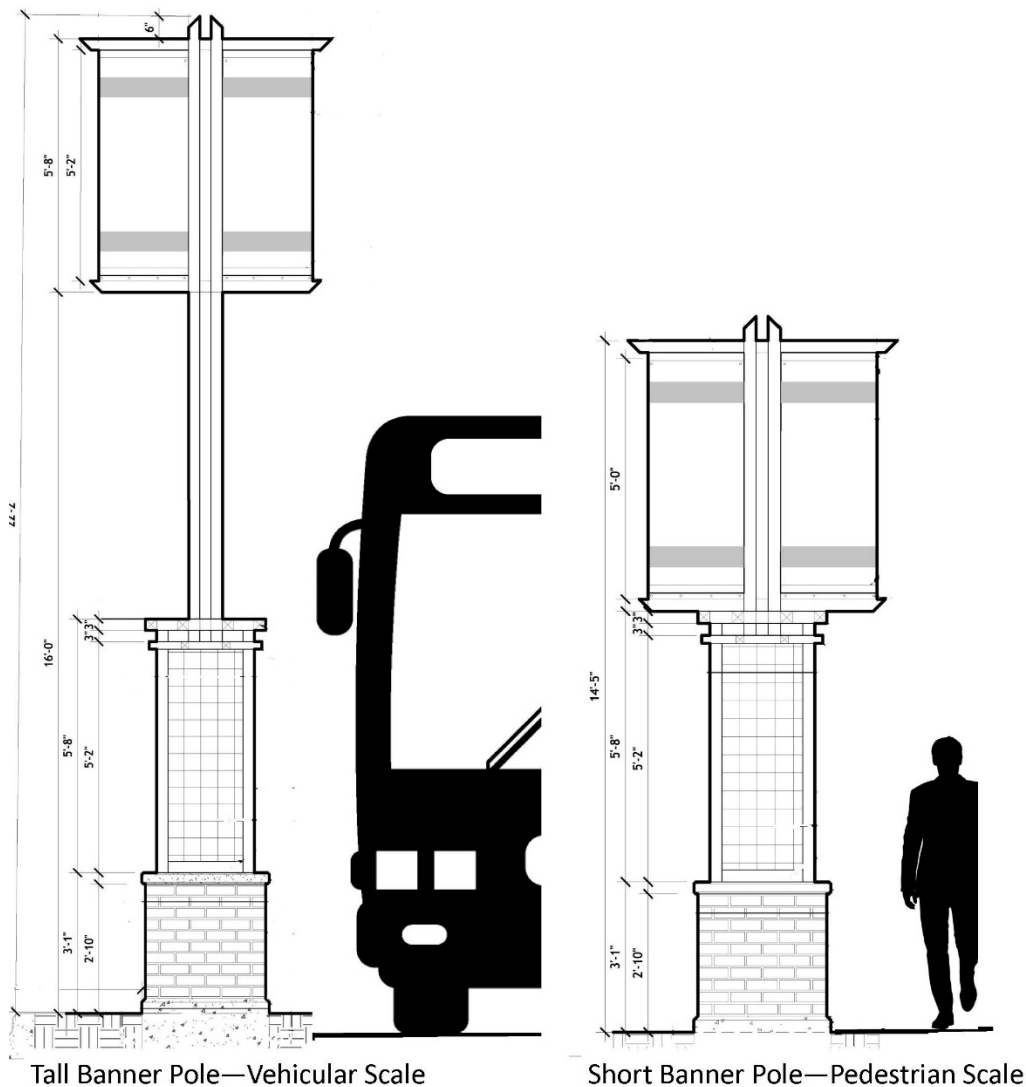

## **32 33 23 Waste and Recycling**

### **Standard Walkway Waste / Recycling Receptacle**

The UI employs a standard trash / recycling receptacle for exterior campus pedestrian and walkway spaces. The trash receptacle is Model DR-1200 as manufactured by Doty & Sons Concrete Products.

- 51" wide x 26" deep x 41" high.
- Tan blend pea gravel exposed aggregate finish.
- Heavy-duty steel double hinged lid powder coated chestnut brown.
- Includes three 30-gallon rectangular, hard plastic liners.
- UI standard vinyl recycling messaging shall be applied to the lids.
- Coordinate specifications with UI PM.

### **Building Level Solid Waste and Recycling**

#### **Yards and Enclosures**

All new and renovated facilities will be provided with a screened, grade-level, exterior concrete surface for solid waste containers and recycling bins.

All ramps or driveways leading to a collection pad must be a minimum of 10' wide. Concrete pads shall be 6" reinforced concrete similar to general sidewalk construction outlined in "32 16 00 Sidewalks" above.

#### **Access**

Yard enclosures and waste containers must be located to allow ease of access for collection vehicles. The grade must be such that the collection truck can approach the unit on a level surface. No parking or other obstructions will be permitted in the access area.

Yard enclosures and waste containers should be located such that collection vehicles do not have to back up more than 100'.

Latah Sanitation Inc. (LSI) collection truck is 8.5' wide, 45' long and 14' high, requiring a 45' turning radius. Provide an obstruction-free vertical clearance of 14' throughout the entire access area, including approach, turnaround and retreat. All collection sites and truck service positions shall provide an obstruction-free vertical clearance of 26'.

#### **Units and Capacities**

Multiple family residential areas should provide a dumpster capable of holding one cubic yard for every four living units.

Classroom and office buildings should typically provide an area large enough to accommodate one six-yard solid waste dumpster and two or three one-yard recycling bins.

<u>Container Capacity</u>	<u>Height</u>	<u>Depth</u>	<u>Width</u>
1 cu yd	48	30	60
2 cu yd	43	34.5	80
3 cu yd	53	43.5	80
4 cu yd	59	51.5	80
6 cu yd	74	66.5	80
8 cu yd	90	71	80

### **Trash Compactors**

Buildings containing food service facilities will also be provided with a roll-off pad and related electrical service to accommodate a trash compactor of a size to be determined by the project needs. It is preferred that trash compactors be located inside a screened yard with water service and trench drains for cleaning and odor control.

Latah Sanitation, Inc and UI Recycling / Solid Waste personnel must be consulted during the programming stage for any project which will require a compactor.

## **Hazardous Materials**

Hazardous or noxious waste must be contained in accordance with the U of I Hazardous Material Policies. Such material may not be placed in solid waste containers.

## **32 80 00 Irrigation**

This section provides a summary outline of the UI standard irrigation requirements. The Design Professional is required to verify all irrigation specifications and requirements with Facilities Utilities & Engineering Services (UES) and the Irrigation Team. Coordinate through the UI PM. The UI PM or UI CAD Manager will provide the DP with the full set of UI standard irrigation specifications and details during the design phase.

### **General**

#### **System Performance Requirements:**

**Water Coverage:** 100% coverage required for all turf and planting areas. Contractor is responsible for prevention of erosion, puddles or soft areas in landscaping due to excessive precipitation or over- installation of heads. The Contractor is responsible for adjustments as required to compensate for declivities, hillsides, and dry areas. Under no circumstances may the nozzle set screws be used to adjust the throw of the sprinkler heads. If any head is throwing a stream of water further than desired, the nozzle must be changed to reduce the throw distance.

#### **Project Conditions:**

**Logistical Information:** Design Professionals shall investigate and determine available water supply, minimum pressure, available water flow and location and size of point of connection.

#### **Sequencing and Scheduling:**

Maintain uninterrupted water and other utility services to buildings, structures, and existing landscape/green spaces. Coordinate temporary water shutoffs, or other temporary utility shutoffs, with the UI CM.

**Pre-Construction Meeting:** No later than two weeks before beginning work on project, a meeting will be scheduled between the contractor, or authorized representatives, and the University's representatives to discuss work schedules, completion dates and storage of materials and equipment.

**Construction Inspections:** During irrigation installation, a UI representative from the irrigation department shall make daily inspections of the project to take digital photos of all trenching, piping, and head placement. This will also allow the contractor to discuss any minor concerns or issues regarding the layout of the system

## **Products, Materials and Manufacturers**

### **Piping:**

All pipe used to install irrigation systems on campus will be PVC (polyvinyl chloride plastic) and will meet current minimum ASTM standards that apply to seamless PVC pressure rated piping. All piping for reclaimed water systems shall be purple. All piping installed in trenches shall not be stacked upon each other. There shall be a minimum of 2" horizontal separation between the pipes within the same trench.

**Sleeves:** All transitions of piping under concrete, asphalt or other materials used for walkways, patios, commons areas or roads will be encased in a Schedule 40 PVC sleeve with a minimum 3" diameter (2" min. diameter for wire only sleeves). Any large size piping sleeves SHALL be 2x the diameter of the pipe. Sleeves will be schedule 40 and each end will be sealed to prevent dirt and debris from sloughing into the body of the sleeve. Sleeves will extend to 6" past edge of surface being traversed and will have a depth of not less than 12" below grade and no greater than 24". Sleeves will be located as per design, or as specified by university representative. Locations will be clearly and accurately marked on drawings by installer. Only one irrigation pipe (i.e. mainline or lateral line) is allowed per sleeve. Control wires will always be placed in their own sleeve.

Laterals or Circuit Piping: Schedule 40 PVC. All solvent welds will use medium or heavy bodied solvent and purple primer.

Mainlines: Schedule 40 PVC. Installations up to 4" will use solvent welds. Installations over 4" will use gasket connections or solvent welds when approved. All solvent welds will use a heavy bodied solvent and purple primer. Any piping inside a building or steam tunnel will be rigid Type K copper installed by a licensed plumber.

#### Fittings:

All glued fittings will be Schedule 40 or Schedule 80 PVC solvent weld fittings. Threaded fittings will be Schedule 80 PVC only. Gasket fittings will use materials designed for use with such installations. All solvent welds will use medium or heavy body solvent, all threaded fittings will use Teflon thread tape or thread sealant (pipe thread compound).

#### Thrust Blocking:

All installations of irrigation pipe 3" and above will have thrust blocking installed at all points of intersection where changes in direction of flow equal to 45 deg. or greater. Thrust blocking may be required on other applications due to potential water hammer and to prevent excessive movement at valves and junctions.

#### Control Valves:

All electric control valves will be Rainbird PEB, or Hunter ICV type valves. All multiple control valve assemblies must be installed using a manifold with one valve per valve box with locations as indicated on the print and set in specified valve boxes unless otherwise approved. All valves shall be installed with TOE schedule 80 nipples unless otherwise approved. Appropriately sized unions shall be installed upstream and downstream of all control valves to allow easy removal of valve if necessary. All valves will be mounted flush and parallel with the ground and with minimum 4" of clearance between top of valve and bottom of valve box lid. Valves shall be centered within the valve box to allow easy access to all sides of the valve. All control valves must be installed at 18" depth, i.e. same depth as mainline. The downstream side of the valve piping shall maintain the minimum 12" depth for proper trench coverage by using no greater than a 45-degree fitting to achieve this. All electric control valves shall have a Rainbird PRS-Dial or Hunter Accu-Sync pressure regulating device installed before project completion. (See UI Standard Control Valve Detail – UI PM or CAD Manager can supply upon request.)

#### Isolation Valves:

All isolation valves will be brass bodied curb stop or gate valves of same size as attached mainline or larger made by McDonald, American, Ford, Milwaukee, or Mueller. Other manufacturers require approval by the UI irrigation department or campus landscape manager. An isolation valve is required at the point of connection, at any stand-alone valve and any multiple valve manifolds unless otherwise approved by campus landscape manager or irrigation department. If P.O.C. is located indoors contractor will provide an isolation valve directly after mainline exits building.

#### Controllers:

All controllers will be commercial exterior type. No mounts inside of buildings will be accepted. Controllers may be pedestal mounted where necessary and according to UI specifications. Connection to power supply must meet NEC (National Electric Code) and campus codes. Mountings will be made to be permanent and controllers must be lockable. All controllers will be Hunter I-Core or Calsense 3000 series for use with standard wire or two wire decoder systems unless otherwise approved by irrigation department or campus landscape manager.

#### Control Wire(s):

Any control wires separated from pipe or buried independently will need to be sleeved in grey Schedule 40 PVC pipe.

All control wires shall be AWG 14 conventional irrigation wire or AWG 14 shielded 2 wire made for Hunter or Rainbird two (2) wire decoder systems. Two (2) wire shall be installed following manufacturer's instructions for proper grounding and proper use of lightning arrester/line surge protector modules, with arrester/surge protector located in separate valve box. Wire will be laid underneath and secured to piping with tape every 6 ft. with 12" loops at all changes of direction equivalent to 90 deg. or more. Splices shall be connected solidly



and encased in 3M DBR/Y-6 waterproof connectors. All wire splices shall be installed within a valve box (10" round minimum) with enough wire to extend 12" above finished grade. If using conventional irrigation wire contractor will install two extra power wires (color other than white or red) from controller to every isolated control valve and every multiple control valve manifold. No more than one valve per controller station.

#### Tracer Wire(s):

Tracer wire is required for all installed PVC pipe. Wire will be 14-gauge minimum high strength copper clad steel (CCS) wire and coated or jacketed with HDPE or HMWPE for direct burial applications, no THHN (nylon) coated wire will be accepted. Mainline will have tracer wire from P.O.C. to every control valve (mainline tracer wire does not need to be looped up at each valve). Lateral lines will have tracer wire from control valve to every terminal end. At control valve boxes there will be minimum 12" of extra tracer wire past finish grade height. All tracer wire splices will use 3M "Scotchcast" connector sealing packets (3570G-N). Tracer wire splices can be directly buried, and all tracer wire will be tested for accuracy before completion date. All tracer wire must be secured to bottom half of all mainline and lateral line pipe with tape every 6 ft. All tracer wire has to be a different color than control wire.

#### Sprinklers / Drip Systems:

No solid set above ground sprinklers are allowed on campus except by approval on temporary basis where dust control or plant storage areas require it. All above ground, temporary apparatus will be removed prior to final acceptance of work. Tops of sprinklers used with effluent water source to be indicated w/purple cap.

Turf: Only Hunter Pro Series 4 inch pop-up (Pros-04-PRS40-CV) series spray heads and accompanying Hunter MP Rotator, Rainbird MPR series, and Rainbird VAN (used only for odd angles) nozzles will be allowed. Hunter PGJ, I 20, I 25, and I 40 series rotor heads. Maximum pop up height for all type of sprinkler heads shall be 6". Spray and rotor heads with maximum height of 6" shall be used as bottom inlet only and may only be installed when pre-approved by university irrigation department or campus landscape manager. All rotor heads will have built in check valves and stainless steel risers where offered. Tops of sprinklers used with effluent/reclaimed water sources to be indicated with purple cap. (See Irrigation Head Details)

Shrub and Planting Areas: Planting areas will only be watered with a drip tubing system. All drip applications require a Rainbird RBY Filter same size as control valve with 200 mesh (75 micron) filter screen directly downstream of control valve. Drip tubing shall be either: Rainbird XFD-06-12, Hunter PLD-06-12 or Netafim TLDL-06-12. Appropriate 17 mm size fittings are required for connections to tubing. Tubing shall be staked every 18" (minimum) with 6" galvanized landscape staples. Tubing shall be laid out in looped or grid rows with a maximum distance of 18" between rows. Flush valves shall be installed at the low point of the flush header, the farthest point away from the control valve and placed in a 10" round valve box. (See Drip Irrigation Detail) Trees shall have a minimum of two (2) connecting concentric rings of drip tubing based upon the diameter of the root ball. The first ring shall be ½ of the radius of the root ball and the second shall be the diameter of the root ball. Shrub-heads, bubblers or any specialty apparatus or nozzle, must be approved by campus landscape manager or irrigation department prior to installation.

#### Swing Joints:

All sprinkler heads shall be fitted with a swing joint assembly. These shall be made up of Marlex (HDPE) fittings which consist of three 90-degree elbows and appropriate length PVC Sch. 80 nipples. Nipples will be no less than 8" in length. Pre-manufactured swing joint made by Dura, Lasco, Rainbird or Hunter may also be used. "Funny pipe" or "swing pipe" and related parts will not be allowed. (See UI Standard Sprinkler Head Detail – UI PM or CAD Manager can supply upon request.)

#### Valve Boxes:

Boxes shall be manufactured by CARSON only, of a size and type specified by blueprint. Only 10" round or larger boxes will be accepted on campus. Valve boxes must be sized so that no valve part is outside the confines of the box and will allow valves to be operated and/or removed without removing or excavating the valve box. Valve boxes used in reclaimed water systems must be purple. All valve boxes shall be installed with a minimum of 6" gravel base under the box. Concrete bricks are required under each corner of box, with round boxes only requiring three, to support and reduce chances of settling so box will be flush with final grade. Valve boxes located in turf areas will be installed at finish grade. Valve boxes located in shrub beds will be installed 3" above finish grade.

### Quick Connect Couplers:

Quick couplers will be brass bodied valves manufactured by Rainbird only, of a size as specified by blueprint. Caps will indicate type of water source: yellow - potable (domestic) water using only 44RC and 33DRC valves; purple - effluent (reclaimed) water will use only 44NP and 33DNP valves. A quick coupler of 1" shall be installed near the point of connection or directly after the backflow device of domestic water systems to be used for winterization. Quick couplers shall be connected by means of a pre-manufactured swing joint made by Dura, Lasko, Rainbird, or Hunter. Quick coupler will be secured to a steel concrete stake (18" minimum in length) with a minimum of two (2) stainless steel screw down hose clamps. The quick coupler shall be installed within a 10" round valve box. The coupler will be centered within the box with the top of the valve no more than 2" from the bottom of the box lid. Quick connect couplers are required at the beginning and end of any newly constructed systems. (See UI Standard Quick Coupler Valve Detail – UI PM or CAD Manager can supply upon request.)

### Backflow Prevention Assemblies:

All backflow prevention equipment pertaining to the installation of irrigation systems will be brass bodied double check assemblies (unless specified otherwise) as manufactured by FEBCO, WILKINS, or WATTS. No double check assembly will be installed with input and output ports of less than 1" pipe diameter. All assemblies will be mounted so as to allow easy access to test cocks and shut-off valves. Locations will be as such to allow access for testing and repairs. Backflow assemblies will be installed as per specifications of the state of Idaho and UI Utilities department (Water Purveyor). Locations for assemblies will be provided on blueprint or by the UI Water Systems Manager. After installation, assembly will be tested and passed by a licensed Idaho Cross-Connect tester with a tag attached to assembly recording the date of inspection, its operational status and the name, contracting company, certificate number and issuing date of the tester. A copy of this information will be provided to the UI Water Systems Manager.

### Reclaimed Systems:

All components: i.e. piping, valves, heads, and valve boxes that are used in the construction of an irrigation system using reclaimed water shall be purple in color to indicate such a system.

## **Installation Requirements**

### Trenching:

All trenches to be cut in established green spaces will first have the route marked out and approved by irrigation department, campus landscape manager and campus horticulturist PRIOR to any trenching. Particular care should be taken to design routes that avoid tree root drip zones. The sod will then be cut along approved route and stored in a manner as to keep it viable during construction. All trenches will be back-filled and settled to 95% by water tamping and additional topsoil will be added as needed. Existing sod will then be laid back over trench. If existing sod dies or is damaged during construction, contractor shall supply new sod. All fill material, native or imported, will be free of debris and rocks larger than ½". Contractor is responsible for any injuries or damage due to open trenches or equipment operation during the execution of contract. Adequate safety measures in the use of warning signs, barrier fencing, barricades and other such devices or measures deemed necessary will be used at all times.

Main Lines: Trenches for main lines shall be of a depth as to allow 16" minimum of cover from the top of the pipe to grade height.

Circuit or Lateral Lines: Trenches for circuit or lateral lines shall be of a depth as to allow 12" coverage from the top of pipe to grade height.

### PVC Pipe Installation:

All welded joints will be clean and free of debris prior to gluing. All threaded connections will use Teflon thread tape. Primer/solvent will be used on pipe and fitting ends prior to glue application. Contractor will prevent excessive accumulations of primer in the cups of fittings. Glue will be applied in such quantities as necessary to cover the inside of the cup of the female and the spigot of the male end. Pipes will be joined using a ¼ turn and form a 1/8" bead of excess glue around the surface of the pipe. All glue applications require primer (purple only) to be visible after fittings dry and set. Contractor will ensure that all glued connections are fully seated within their fittings. Contractor will ensure that all welds are solid and all connections leak free. No fittings will be installed in a stressed condition by forcing or bending the pipe to fit.

All changes in direction shall be accomplished by using standard PVC fittings. No changes in direction will be made by force bending the pipe itself or using stressed fittings. If the pipe will not follow the desired path in a natural unstressed condition, appropriate fittings shall be used to accomplish the necessary change in direction. Piping shall be laid within the trench such that there is no stacking of the pipes and there is a minimum of 2" horizontal separation between pipes.

#### Control Valve Installation:

All valves will be located at a minimum distance of 18" away from any hardscape. All new valve assemblies or manifolds will allow a minimum of 4" of unobstructed piping between fittings on the upstream side of valves. All fittings will be glue and solvent weld except on the inlet and outlet side of the valve which will be threaded male fittings (PVC only) Teflon thread tape will be used to seal fittings attached to inlet and outlet ports of valves. No use of pipe thread compounds will be allowed. Manifolds will be built of a size as to fit in an appropriately sized valve box with adequate room between valves for repair. In single and multiple valve manifold installations, each manifold will have a separately installed isolation valve to allow repairs to that manifold without interfering with the normal operation of the remaining manifolds on the system. All valve boxes will be set so that top and lid are at finish grade. All valve boxes will be installed in such a way as to protect PVC piping from damage by settling.

#### Sprinkler Installation:

Sprinklers will be attached to PVC using threaded connections only. All lines will be flushed prior to installing heads. Sprinklers will be installed in zones of similar precipitation rates and coverage. No zones combining full and partial circles will be accepted. All sprinklers will be connected using an acceptable swing joint. (See fig.) All sprinklers will be set so the top is at finish grade height in turf and shrub areas. (Some plantings may require different head settings – consult drawings and/or irrigation department/campus landscape manager for clarification and identification.) All sprinkler heads should be plumb and 2" – 3" from hardscape edge. Irrigation heads adjacent to buildings should not be closer than 12" from exterior walls. All sprinklers should be adjusted to provide 100% coverage in zones and will be adjusted as to limit over sprays on walks, buildings, cars, etc.

### **Project Completion and Acceptance**

#### Inspection:

All newly installed irrigation will be tested before completion of project. All new installations must use correct installation methods, be free of leaks and settling of trenches. Inspections will consist of visually observing all newly installed irrigation while system is in use. Every station will be inspected while running for a minimum of 5 minutes per valve. Mainline will be fully pressurized, at which point a pressure gauge will be applied. Pressure must be maintained and cannot drop below 5 psi within a thirty-minute period or system will not be accepted.

#### Operation:

System will be operated on a zone by zone basis, with representatives of the UI and contractors present. A list of corrections will be generated at that time, if necessary, and a copy is to be left with contractor. These corrections must be completed before final acceptance is given. System will then be programmed to run a short test (2 to 3 min. per station) to demonstrate the operation of the controller and that it tracks from valve to valve. Any corrections listed during this test must be corrected before acceptance will be given.

#### Acceptance:

Once the system passes all tests and all corrections have been made, the appropriate university representative will acknowledge that the system meets UI standards, and that the contract was executed accordingly.

#### Warranty:

Contractor will be liable for any repairs and redesigns due to improper installation and design methods for one (1) year from completion date at no cost to University of Idaho. University of Idaho retains the right to make emergency repairs without relieving the contractor's guarantee obligations.

## **32 90 00 Campus Landscape**

The university's physical environment is one of its greatest assets. UI's legacy of premier open space was created during the earliest years of campus development. Today the beautiful setting and campus green areas supports the UI's vision to be a university of choice in the West for high-quality and innovative undergraduate and graduate degree programs, inter-disciplinary learning, and a residential campus experience.

The 130-year history of the campus has brought many positive enhancements to the natural campus landscape, from the Administration Lawn and the original Olmsted plan for campus, to the Shattuck Arboretum and the UI Arboretum and Botanical Garden. The natural, historical, and designed elements together form a unique and beautiful open space framework that characterizes the University of Idaho and is regarded as a unique signature for campus.

An attractive campus environment promotes recruitment and retention, and provides physical, social, psychological, educational, and aesthetic benefits. The educational benefits include opportunities for outdoor classroom settings and outdoor labs for studying horticulture, botany and landscape design.

## **32 91 00 Tree and Plant Protection**

The Design Professional shall include the following landscape protection requirements in the specifications for every project regardless of size or scope.

### **General**

Trees and shrubs are valuable resources on campus; each tree having been individually planted over the last 130 years. Trees of high value include rare species, trees that were planted by historical dignitaries, and trees that have been dedicated to groups and individuals. The value of certain trees and/or groups of trees is inestimable.

The Contractor shall exercise care to protect all turf areas, trees, and shrubs. Trees and shrubs will require replacement if damaged as determined by the Owner.

To prevent unnecessary soil compaction and damage to tree root systems, it is highly recommended that the contractor uses appropriately sized equipment for construction operations in and around existing landscaping. The impact from oversized equipment is one of the leading causes of peripheral, unnecessary damage to nearby soils that contain tree root systems. Unless landscape areas are to be completely re-built as part of the project design, no tracked or wheeled equipment of any size will be allowed on UI turf or landscape areas without the use of pressure relieving mats or double layers of 3/4" plywood under all points of contact. All work on turf or landscape areas must be approved by the UI CM and UI Landscape Representative prior to the start of work.

The UI CM and UI Landscape personnel will monitor the Contractor's work and will have the final say on matters concerning these issues.

There are five primary goals for landscape protection on any construction project:

1. To protect the soil (turf and tree root environments) from compaction
2. To protect the trees, shrubs, and turf from injury
3. To protect the underground irrigation systems from damage
4. To restore the sites to their original condition
5. To minimize the contractor's site restoration costs

### **Coordination**

Coordinate protection and restoration procedures with the UI Landscape representative. To facilitate this directive, a walkthrough, prior to the start of construction activities, between the construction supervisor(s)

and the UI Landscape representative will be coordinated by the UI PM and UI CM (Construction Manager). Information about careful operation near the trees is to be given to all equipment operators.

### **Protection of Soil, Tree / Turf Root Systems and Underground Irrigation**

Selected trees and tree groupings located within and adjacent to the construction zone shall be protected by chain link or similar fencing. The UI Landscape representative will decide locations of this protective fencing after conferring with the contractor. Supplemental fencing may be installed by UI Landscape personnel. Once installed, repositioning of the fencing must be approved by the UI Landscape representative. Construction activity is not permitted within the tree and landscape protection zones created by the fencing. Protective barrier-type fencing is the most effective method of preventing unnecessary soil compaction and injury to tree roots/trunks/branches.

Within the construction zone, as needed, a thick layer of wood chips will be installed on the landscape by UI Landscape personnel to help prevent soil compaction. Duradeck Mats, 2-inch thick planking or  $\frac{3}{4}$ " thick plywood or greater should be placed over turf and planting bed areas wherever rutting, irrigation system damage, or excessive soil compaction from construction equipment and vehicles will likely occur.

It is the responsibility of the contractor to maintain and water any trees or plant materials protected by a tree protection zone within the construction site limits. The soil around trees and plants must be saturated with water at approximately two-week intervals depending upon the weather conditions.

Driving and parking vehicles and equipment should be limited, as possible, to hardscape (concrete and asphalt surfaces) areas only unless otherwise approved by the UI CM.

Staging areas used for equipment and materials storage are to be located on hardscape areas unless otherwise approved by the UI CM.

Concrete mixing and cleaning/washing of concrete tools/booms/etc. are to occur in designated hardscape locations only. This activity can only occur on the landscape, only if containment basins or similar are used. The landscape soil is to remain free of contaminants such as concrete spillage, chemical spills, fuel spills, etc.

During excavation near large trees, a UI Landscape representative will be called by the contractor to standby and assist with large root cutting, as needed. Severed roots are to be pruned with clean cuts back to the trench wall. Large root ripping and tearing away from the trench and towards the trunk by heavy equipment is to be avoided.

Where trenching under the dripline of a large tree (greater than 6 inches in caliper diameter) is required, tunneling under or going around the buttress and lateral-anchoring roots is imperative to ensure tree stability. Do not cut through these roots! Boring under this part of the root system is the recommended and preferred method for accomplishing the work and maintaining the integrity and safety of the tree in question.

As part of the underground utilities locate service, underground irrigation systems within the construction zone will be located by a UI Landscape or Irrigation representative. Irrigation heads and valve boxes will be marked. Any system modifications prior to excavation or repairs needed afterwards will be performed by a UI Landscape representative.

### **Protection of Tree Trunks and Branches**

During excavation, removed soil should not be placed against tree trunks. This measure protects the trunks from mechanical injury during subsequent backfilling.

Any tree pruning is to be performed by a UI-LES representative. Pruning or breaking of branches by contractor equipment or personnel is strictly prohibited. If a UI representative is not available, all pruning shall be done by the contractor at a professional level adhering to the American National Standard for Tree Care Operations", ANSI A300-1995, and International Society of Arboriculture Standards. If this service cannot be performed at that level by the contractor, then a certified, licensed, and insured arborist shall be

hired to perform the work.

Avoid contact of tree trunk and branches by equipment, vehicles and tools. Injury and wounding of the protective bark layer could lead to life-threatening disease infection or insect infestation.

### **Landscape Restoration**

All excavations within landscape areas will be filled with proper fill soil above utility piping and surrounding support materials. Topsoil, as specified by the UI Landscape representative, will be placed in the top 18" of all excavations within landscape areas. (Refer to "32 91 19 – Topsoil Placement and Grading".)

Trenches and excavations shall be backfilled and raked to a grade two inches above grade (to allow for settling) and a fine finish. Hydroseeding with a near-matching seed mix shall be used to reseed the disturbed turf areas.

Ruts made in the landscape from vehicles and equipment related to the construction project will be completely excavated and repaired to match original conditions following all UI standard requirements for topsoil and planting.

All debris, construction material, contained concrete spillage, etc. is to be removed once construction is complete.

Underground irrigation systems impacted by construction activities will be repaired to pre-construction conditions, following the standard UI irrigation guidelines in "32 80 00 – Irrigation", and checked for proper operation by a UI Landscape representative prior to project completion

## **32 91 19 Topsoil Placement and Grading**

### **Topsoil**

All required topsoil must be imported.

Topsoil depth requirements shall be 6" for lawn areas and 24" for tree or shrub areas.

The UI PM and UI Landscape representative shall approve the source of topsoil and/or fill soil prior to installation.

Include in topsoil mix 20% EKO Compost or an equally comparable product. (EKO Compost is manufactured by EKO Systems of Lewiston, Idaho). Compost shall be mixed into the topsoil using a 1 to 4 ratio of compost to topsoil.

### **Imported Topsoil**

Imported topsoil shall be a fertile, friable, natural loam, soil, representative of productive soils in the vicinity. Topsoil is usually dark in color (often black). It shall be obtained from well-drained areas, free from admixture of subsoil, clay lumps, brush, weeds and other foreign matter, and free of roots, stumps, stones larger than 1.5 inches in any dimension; and free of other extraneous or toxic matter harmful to plant growth and be a hindrance to grading, planting, and maintenance operations. Topsoil should be obtained from local sources. It should have an acidity range (pH) of 5.5-7.5, and an organic matter content between 2-8 %. Loam topsoil must have 7-40 percent clay; 28-60 percent silt; and less than 52 % sand particles. Not more than 1 percent of topsoil weight can be gravel or stones.

### **Fill Soil**

For placement in landscape areas below the topsoil layer: material must be natural friable loam free of lumps, roots, stumps, stones larger than 3 inches in any dimension or other trash and debris. It should not contain more than 10% by weight of gravel and/or stones less than 1.5 inches in any dimensions. It must not contain toxic matter harmful to plant growth. It must have an acidity range (pH) within 5.6 – 7.5 and a particle size distribution as required for topsoil. In most instances soil removed/excavated from the

construction site may be used for Fill Soil going back into the construction site. If there is a question concerning topsoil or fill soil usage, it should be directed to an authorized UI Landscape representative.

### **Grading**

If a slope is to be planted as a lawn and machine mowed, then a 3:1 (33%) grade is the maximum that shall be allowed.

Soil placed against the edge of a walkway in lawn areas should be 1-inch below the walkway surface. In planting beds, 2-inches below the walkway surface is required. These are final grade levels after settling.

After topsoil is applied to landscape renovations sites, whether for turf or other plant materials, the topsoil should be tilled in two different directions to a depth of 4 inches to allow gradework to be accomplished easily by hand or machine. Lightly compact with a cultipacker before planting grass.

The landscape contractor is responsible for providing positive grade away from sidewalks, foundations, landscape plantings and other objects within the landscape so that water flows to a proper drainage exit point or storm sewer and does not pond or settle out within the landscape area itself. Rake the topsoiled area to a uniform and smooth grade throughout to eliminate dips, holes, and pockets that may retain water or hinder future maintenance activities. Remove all trash and stones to a depth of 2 inches.

Turf restoration areas and new gradework must be inspected and accepted by UI Landscape representatives before seeding or sodding.

## **32 92 00 Turf and Grasses**

### **Seed Selection**

Turfgrass seed mixtures are selected according to expected maintenance levels for a particular turf area. Maintenance levels include:

- High / Medium Maintenance: Areas that will receive regular irrigation and mowing.
- Low Maintenance: Areas that will receive minimal irrigation or mowing.
- Dryland: Areas that will receive no mowing or irrigation.

Acceptable products include, but are not limited to, the following: (**Note:** Approved seed selections change frequently as new and/or improved strains are developed. Design Professionals should check with the UI Landscape representative for current seed mixes before every project.)

#### High / Medium Maintenance Areas:

**"Elite Lawn Mix"** consisting of:  
20% Wildhorse Kentucky bluegrass  
20% Midnight Kentucky bluegrass  
20% Famous Kentucky bluegrass  
15% Manhattan 5 Perennial Ryegrass  
15% Exacta II Perennial Ryegrass  
10% Chewings Fescue

#### Low Maintenance Areas:

**"LoGro Mix"** consisting of:  
40% Imagine Perennial Ryegrass  
40% Creeping Red Fescue  
20% Hard Fescue

#### Dryland Areas:

**"Erosion Mix"** consisting of:  
30% Hard Fescue

20% Sheep Fescue  
20% Creeping Red Fescue  
15% Chewings Fescue  
10% Canada Bluegrass  
5% Regreen Sterile Wheatgrass

Seed mixtures are available locally from Grassland West in Clarkston, WA. All seed mixes must meet industry standards for viability / purity and be sown at rates appropriate for each type and mixture.

### **Hydroseed**

Slurry mix shall include fiber mulch, tackifier, water and fertilizer.

Fiber mulch shall be virgin wood fiber, temporarily dyed green, which shall have a nontoxic effect when combined with seed or other materials. When applied, an absorptive or porous mat will result on the surface of the ground. No sawdust or byproduct material will be allowed.

### **Sod**

Sod must be inspected and accepted by the UI Landscape representative before laying sod on campus grounds. The sod must be from an approved source and be weed, insect and disease free. No attempt is made to specify the exact species mix of sod due to the nature of that business, but it will generally be 100% Kentucky Bluegrass or a mixture of KB and Perennial Ryegrass.

Sod shall be freshly cut when delivered to site and installed within 24 hours of delivery.

### **New Turf Maintenance at Project Closeout**

The landscape contractor shall be responsible for the care, fertilization and watering of newly installed grass seed or sod during the turf establishment period for a minimum of six (6) weeks or project Substantial Completion, whichever is later. Complete granular fertilizer of neutral character must be used as a starter fertilizer for seeding grass or sod installations. Use fertilizer providing 1.5 pounds of available slow release nitrogen and 1.0 pounds phosphorus and 0.5 pounds potassium per 1000 square feet of area.

Mow new lawns for at least 3 times or as often as necessary for lawn to become dense and established with at least 95% coverage and no bare area greater than 8 inches in diameter.

## **32 93 00 Plantings**

### **Plant Placement**

Street, Parking Lot, and Sidewalk Lights: To prevent conflicts with tree crowns and proper light dispersion, do not locate the trunks of trees within 15 feet of street, parking lot, or sidewalk light poles.

Vehicular/Pedestrian Sight Clearance: Be aware of adequate vehicular/pedestrian sight lines when locating plants near street intersections, parking lot exists, and crosswalks. Do not locate plants that will reach a mature height of 3 feet or greater within the 40-foot sight triangle of street to street and parking lot to street intersections.

Parking Lot Sight Clearance: Plants located in parking lot planting beds can pose numerous challenges concerning sight clearance. Do not locate plants that will reach a mature height of 3 feet or greater in any of the interior island beds, unless otherwise specified by the UI.

Campus Signage: Examine areas to be landscaped that lie under and adjacent to campus signage (building, parking lot, street, etc.). Be aware of the mature size of plants, and do not locate them in those areas where their growth will obstruct the signs.



**Planting Bed Edges:** Be aware of maximum widths of shrubs and ground covers. Do not locate these plants next to sidewalk/planting bed edges whereby their growth will exceed the edges of the planting beds and infringe upon walkways, turf irrigation heads, lawns, etc.

**Planting Beds:** A thorough understanding of the mature size of each plant species proposed in the design is required. Locating plants with inadequate spacing between them requires future, unnecessary pruning that diminishes the natural shape of the plants and the intended landscape design, or potentially causes their removal. Measure the on-center spacing between plants so that they only touch when at mature size, unless otherwise specified by the UI.

**Grade-Level Utilities:** Do not locate plants next to grade-level utility boxes, generators and/or transformers such that their growth will cover up these boxes. Utility boxes include irrigation, electrical, and water, among other services.

**Building Equipment:** Do not locate plants next to building air exhausts or air intakes; do not locate plants so that they block access to or function of emergency equipment such as transformers, maintenance access, or security equipment.

### **Basic Design Guidelines**

Lawns, other plantings, and constructed elements shall be designed to allow access by an 8-foot wide riding mower. When applicable, design lawn edges with corners rounded at a radius not less than 5 ½ feet.

Plants selected for landscape installations should rate positively on the following characteristics: drought tolerance, insect/disease resistance, and non-aggressiveness. Plants should have a USDA hardiness zone rating of 6a or less.

Large areas of low-growing ground cover support the growth of weeds and accumulate trash. Do not design large areas of ground cover plantings.

Unless otherwise specified, all planting beds that receive trees, shrubs, and/or ground covers shall be excavated to a depth of 2 ½ feet. This will allow the removal of compacted soils, subsoils, construction debris, and other extraneous materials not conducive to plant root growth. Sides of excavation that abut up against sidewalks and other hardscaped surfaces shall be sloped outward to allow adequate foundation support for such surfaces. Irrigation installation, if planned, shall occur after excavation and backfilling.

Do not use landscape fabric for weed suppression and/or erosion control within planting beds.

### **Plant Requirements**

Trees, shrubs, and ground covers shall conform with the American Association of Nurserymen Standards, ANSI Z60.1.

Trees, shrubs, and ground covers shall be symmetrical, well-branched, well-formed and typical for variety and species. They should be full-foliaged when in-leaf.

Root crowns of trees shall be above ground level. Trees delivered to the site with root crowns buried in the root ball shall be inspected by the owner to determine if removing soil from the top of the root balls to expose the top of the root crown is sufficient to gain acceptance of the trees. If this procedure is unsuccessful and further soil removal is not recommended, then the trees shall be rejected.

Trees, shrubs and ground covers shall be free from disease, insects, and defects such as sunscald on the trunk, abrasions, gashes, windburn, breaks in main trunk/laterals, and other injury.

Trees, shrubs and ground covers shall have sufficient roots to hold earth intact after rootball is removed from the container without being rootbound. Trees and shrubs with excessive circling roots shall be rejected.

Trees, shrubs, and ground covers shall be nursery-grown for a minimum of 8-months under climatic

conditions similar to those in the project area.

Trees, shrubs, and groundcovers shall not be pruned prior to delivery except as authorized by the UI. Trees shall not have fresh pruning cuts over 1-inch diameter, and not have been topped, sheared, or tipped.

Species, cultivar and size substitutions will be allowed only when a specified species, cultivar and/or size is proven unavailable and only with the UI's approval.

Delivered trees, shrubs and ground covers shall each have a legible label giving the common and botanical name in accordance with the "Standardized Plant Names" as issued by the "American Joint committee on Horticulture Nomenclature". If these plants are bundled or in multiple unit containers such as flats, one tag shall be placed on the bundle or container and shall additionally give the number of plants contained in the bundle or container.

### **Planting Restrictions**

Do not install plants when soils are saturated.

Do not install plants when soils are frozen.

Do not plant during freezing weather or when temperatures are above 90 degrees Fahrenheit.

Do not seed/hydroseed after September 30 or before April 15.

### **Contractor Maintenance During Construction**

It is the responsibility of the contractor to keep all plants alive and in good condition during the delivery, holding, installation and maintenance periods. Begin maintenance on new plants immediately after delivery and continue until Final Acceptance.

Maintenance includes:

- Watering plants. This is the most critical maintenance task assigned to the contractor. The contractor shall inspect the plants, including lawns, on a regular basis to ensure proper and adequate watering. Coordination between the contractor and UI may need to be established to provide efficient coverage for project plants and adjacent existing landscaping.
- Controlling weeds in planting beds, lawns, and any other planted areas.
- Pruning trees, shrubs, and ground covers that have noticeable deadwood and/or broken branches. Follow International Society of Arboriculture's Best Management Practices for pruning trees.
- Treating plants for insect or disease problems.
- Repairing tree staking materials and resetting trees and shrubs to proper grades or vertical position as specified.

# DIVISION 33 – UTILITIES

## **33 01 00    General**

### **District Energy Systems**

The University of Idaho uses a district energy system for the heating and cooling needs of campus. District energy systems produce utilities such as steam, chilled water, and compressed air for use in multiple buildings. The District Energy Plant at the University of Idaho (often referred to as the steam plant or energy plant) distributes utilities to campus buildings through tunnels located under sidewalks and roads. The steam plant utilizes a biomass boiler fueled by wood chips sourced from local wood mill residue and waste products.

Chilled water is produced using a combination of electric vapor compression chillers and absorption chillers at two central locations on campus. The North Campus Chiller Plant (NCCP) is located inside the District Energy Plant. The South Campus Chiller Plant (SCCP) is located above the Kibbie Dome, next to the Golf Course. The system provides chilled water for process cooling loads.

Besides the chillers, the University of Idaho operates a two-million gallon chilled water Thermal Energy Storage (TES) tank. The university uses the TES to meet peak load demands during the day without running additional chillers, increasing system efficiency.

### **University of Idaho Utilities Public / Private Partnership**

In January of 2021, the University entered into a 50-year agreement with a utility concessionaire as part of a public-private partnership (P3) that involves the long-term lease and operation of the University's utility energy system. The agreement is with Sacyr Infrastructure USA and Plenary Americas USA Ltd (SPUPI) who, in turn, have partnered with McKinstry to manage the operations and maintenance of the utility systems. The utilities scope included in the P3 partnership is comprised of eight distinct utility systems to include: chilled water, steam / condensate, electrical distribution, domestic water, compressed air, stormwater, sanitary sewer, and reclaimed water.

In addition to the daily operations and management of utility systems, McKinstry will manage the development and delivery of all capital projects associated with campus utility systems. All capital project work, to include new buildings, building additions and/or remodels, that may impact portions of the campus utility systems, shall be coordinated with McKinstry in partnership with UI AES.

### **Demarcation Points**

As part of the agreement between the University of Idaho and the utility concessionaire (SPUPI / McKinstry), clear demarcation points have been established to define which components are part of the utility system managed by the concessionaire, and which components are part of the building systems managed by UI Facilities.

#### Chilled Water:

All chilled water plants, to include north campus chiller plant, south campus chiller Plant, and the McClure plant, and all distribution up to the campus building envelopes interface control valves, interface meters and interface programmable logic controllers shall be considered part of the chilled water utility system.

Any building/secondary pump, building piping, heat exchange equipment and valves downstream of the interface equipment contained within the building envelopes shall not be considered part of the chilled water utility system.

Figure 330100-1 – Chilled Water Demarcation

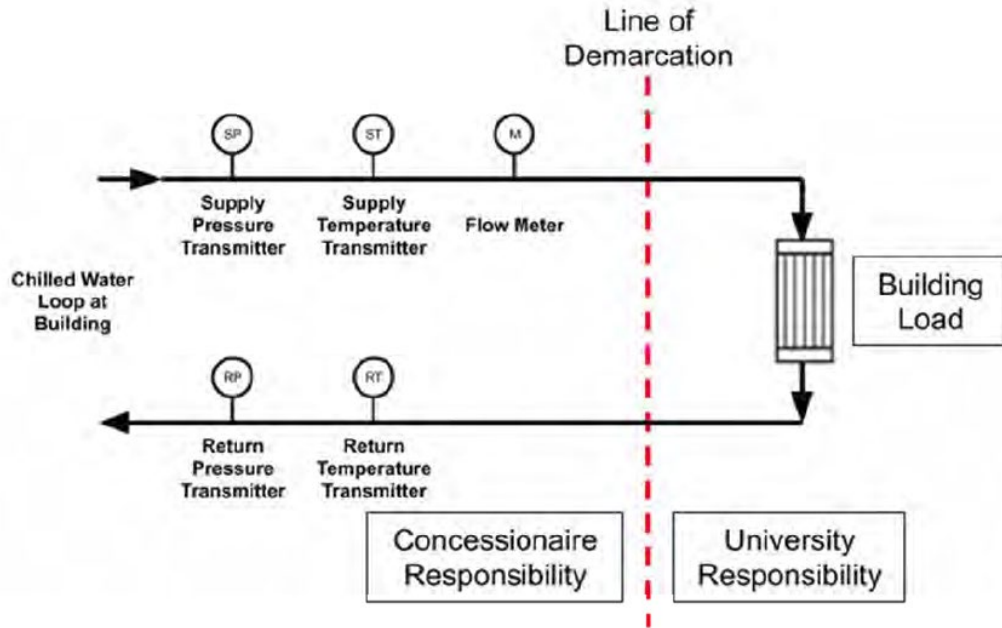

Steam and Condensate:

All steam piping up to the building isolation valve will be considered part of the steam and condensate utility system.

All condensate piping from the condensate receiver pump outlet back to the Energy Plant shall be considered part of the steam and condensate utility system.

Figure 330100-2 – Steam and Condensate Demarcation

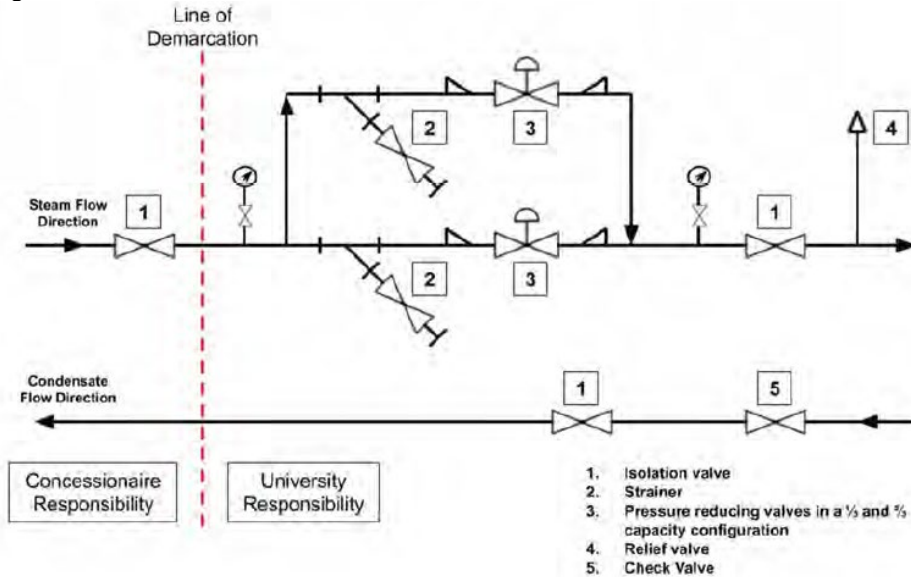

Electrical Distribution

The line of demarcation for the electric system between the University and the concessionaire shall be at the point of presence for the service line, which is the building electrical service meter or, absent a building electrical service meter, the building electrical service switch.

The line of demarcation for the electric system as between the concessionaire and any third-party electricity providers shall be up to the external electrical substation transformers low-side cable terminations.

All cabling, switchgear, transformers, duct banks, manholes, and vaults and substation buildings and associated infrastructure between the external electric utilities and building lines of demarcation shall constitute the electric distribution utility system.

Figure 330100-3 – Electrical Demarcation

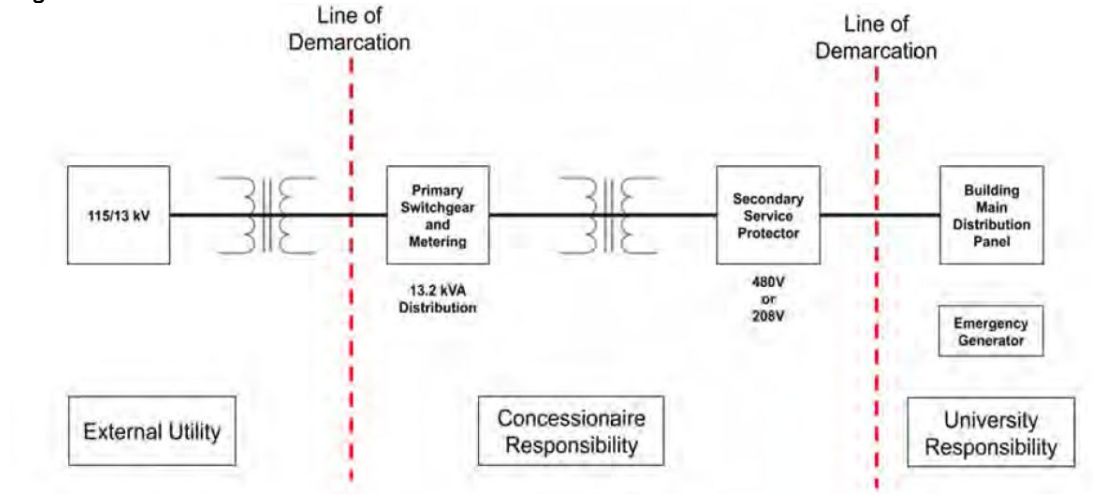

Domestic Water:

Except as otherwise described herein, the line of demarcation for the domestic water system, including building apparatus for firefighting water and fire hydrants, is at the point of diversion from the mainline or meter, whichever occurs first. All backflow assemblies and domestic water meters are included within the domestic water utility system at the main service to the buildings.

All building/secondary pumps, heat exchangers, and associated building piping shall not be considered part of the domestic water utility system except for backflow assemblies and domestic water meters on main building service.

Figure 330100-4 – Domestic Water Demarcation

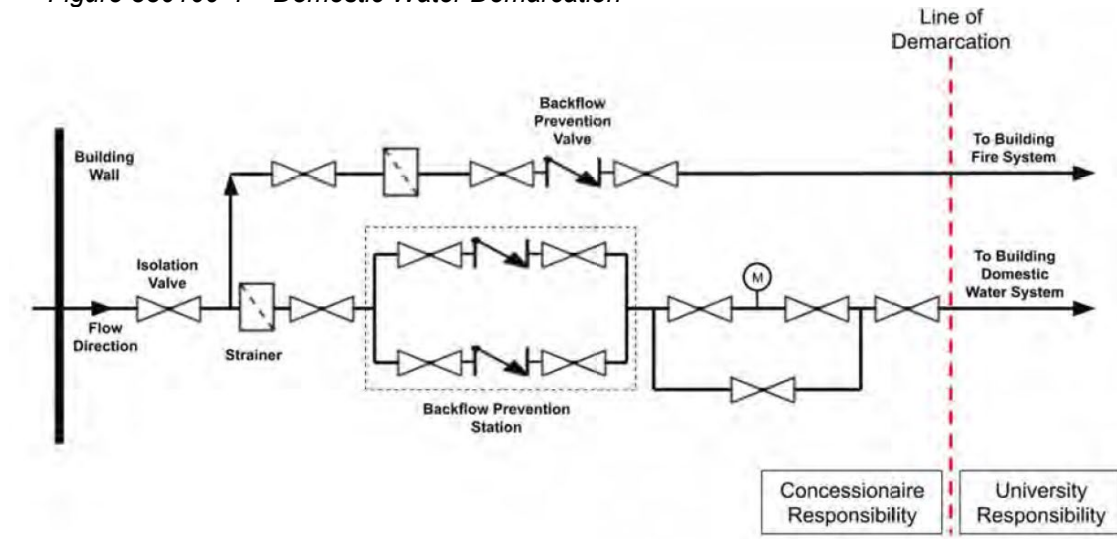
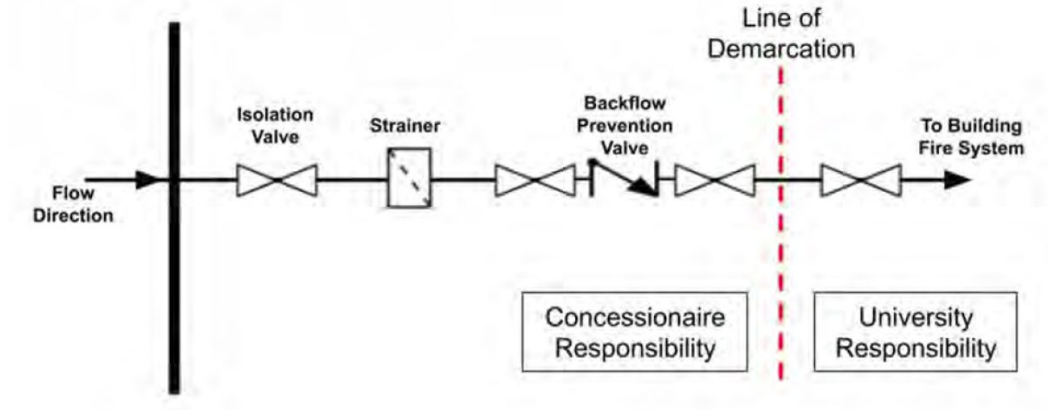

Figure 330100-5 – Fire Service Water Demarcation



Compressed Air:

The line of demarcation for the compressed air utility system is located at the foundation of the Energy Plant and is distributed throughout the district energy tunnel network to individual building mechanical rooms.

All building piping, valves, and associated equipment shall not be considered part of the compressed air utility system.

Figure 330100-6 – Compressed Air Demarcation

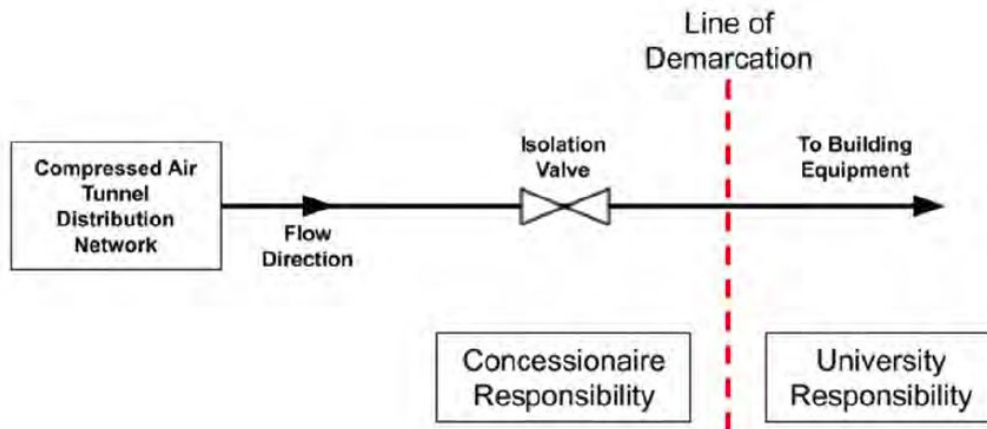

Utility Network System (SCADA):

The utility network is separated from the university campus network by a physical Fortinet firewall which is operated and maintained by the concessionaire. Data shall be made available outside the utility network via a university approved SCADA and control system server. This server shall exist behind the physical firewall and shall maintain the capability to pass data to a University-owned PI Server, which resides on the University's network.

Additionally, the utility network system extends into university buildings to collect metering data from utility system meters.

Storm Water:

The storm water utility system shall include all piping, valves, manholes, access points and outfalls used to move storm water from the university campus grounds to the appropriate discharge point.

Demarcation of all storm water systems discharging from any building is two feet from the building envelope. The concessionaire is responsible for the storm water systems starting at the point that is two feet from the structural barrier between the interior and exterior of each building on campus.

Figure 330100-7 – Storm Water Demarcation

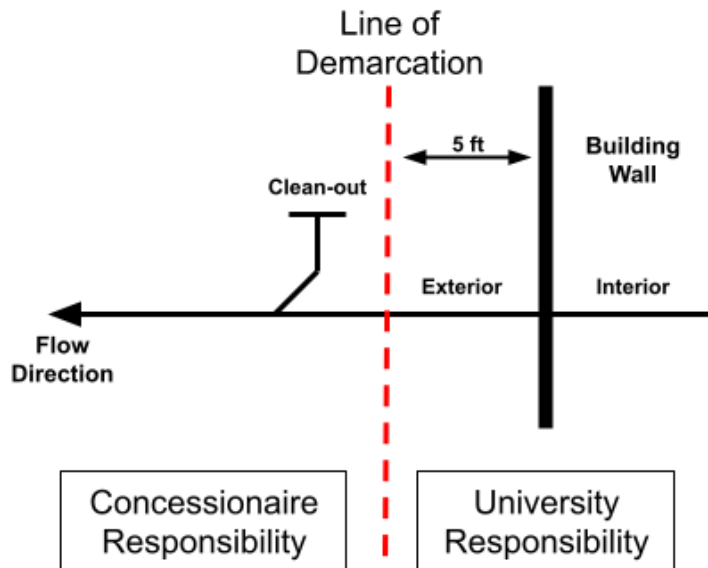

Sanitary Sewer:

The sanitary sewer utility system shall include all piping, valves, manholes and access points used to move wastewater from the university campus buildings to the appropriate discharge into City of Moscow sewer system.

Demarcation of all sanitary sewer systems discharging from any building is two feet from the building envelope. The concessionaire is responsible for the sanitary sewer systems starting at the point that is two feet from the structural barrier between the interior and exterior of each building on campus.

Figure 330100-8 – Sanitary Sewer Demarcation

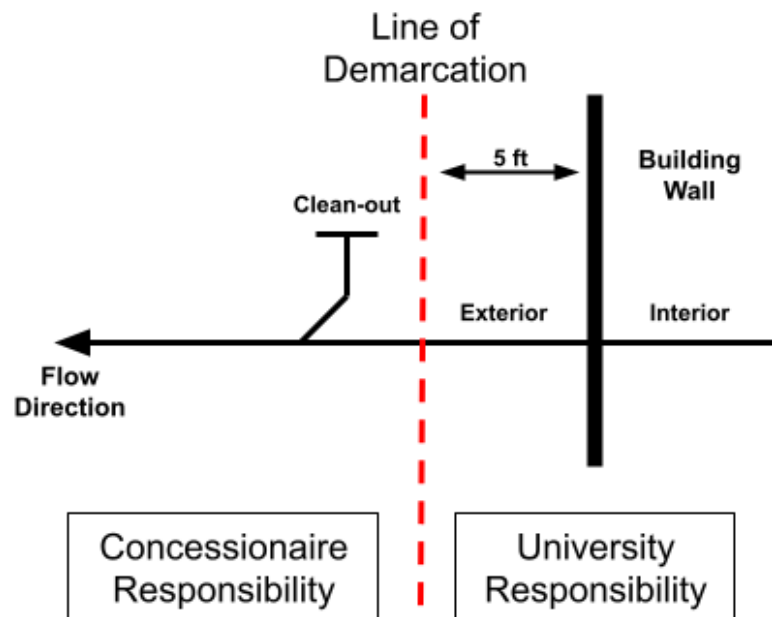

Reclaimed Water:  
See Figures 9 and 10 below for demarcation points.

Figure 330100-9 – Reclaimed Water Demarcation: City of Moscow / Concessionaire

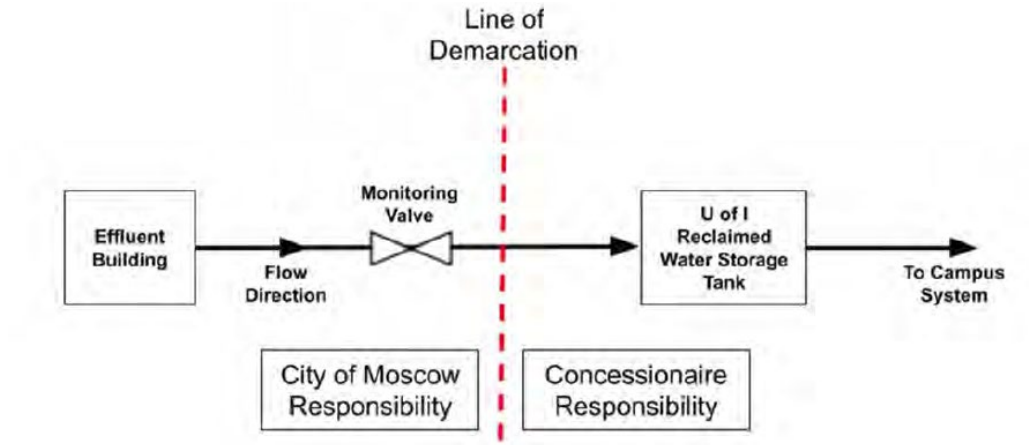
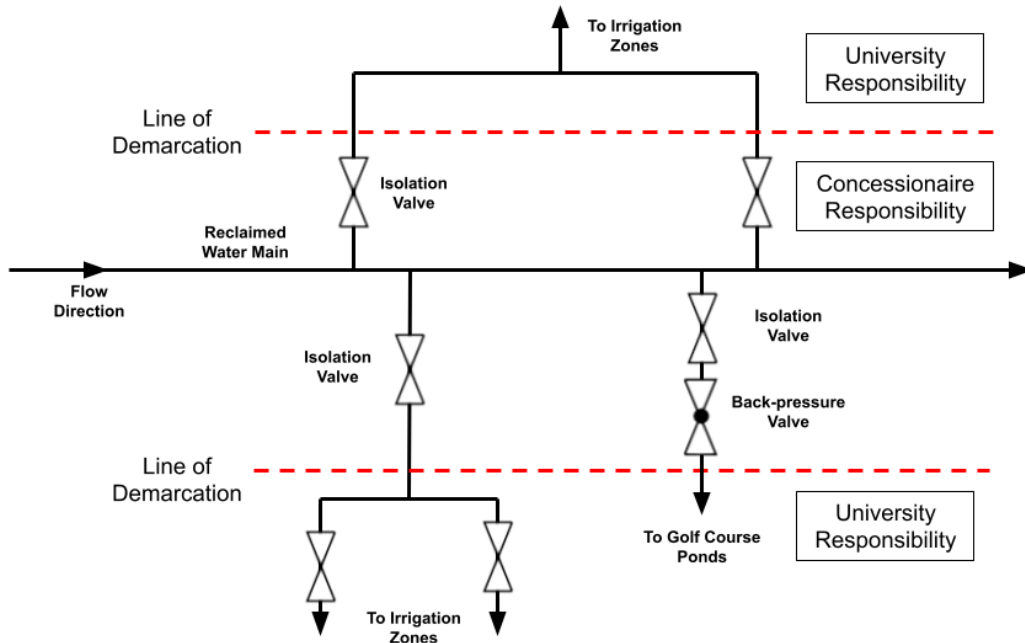

Figure 330100-10 – Reclaimed Water Demarcation: Concessionaire / UI



### **33 09 00 Metering for Utilities**

#### **Utility Metering**

Building meters are required on the following utilities: electricity, domestic water, chilled water, and steam condensate. The metering of irrigation water may be required in some applications. Secondary meters may be required where multiple uses are anticipated, such as charge-back or for-profit operations.



Metering at the utility level will be provided as part of the utility concessionaires' (McKinstry) scope. Sub-metering at the building level will be considered part of the University's scope. The general demarcation points between utility systems and University systems are described in Section 31 01 00 above. Design Professionals shall verify the scope of all metering on all projects through both UI AES and McKinstry.

### **Campus Standard Meters**

Meters shall be Schweitzer Engineering Laboratories Model SEL-735.

- Part Number: 0735AX00941CXXXXXX16101XX for reading buildings without sub-metered utilities.
- Part Number: 0735AX00941CXXA1XX16101XX for reading sub-metered utilities.
- Confirm exact part number(s) with the UI prior to ordering.

Multiple SEL meters are required for full utility metering coverage.

SEL meters will require connection to multiple mechanical utility meters and sensors for intended metering. The Design Professional shall coordinate with Divisions 22 and 23 and include specific interconnection details including, communication protocol, wire type, etc.

The metering system shall communicate with the existing campus metering network for data aggregation and reporting and be remotely accessible from a remote interface. Furnish gateways, network interfaces, communication wiring, programming, startup, etc as required to interface with the existing campus metering network. Verify all requirements with UI Utilities and Engineering Services (UI UES)

Provide a 1" conduit for a data drop connection to each new meter. Coordinate and include this in the Division 26 documents.

### **Electrical System Metering**

The metering system shall record and report total building electrical demand. This shall be achieved by summing the meter data on the (2) main services. The metering system shall record and report data for the building electrical services individually.

The metering system shall record and report total generator electrical demand. This shall be achieved by summing the meter data on the (2) automatic transfer switches. The metering system shall record and report data for the automatic transfer switches individually.

### **Mechanical Utility Service Metering**

The metering system shall collect data from the following mechanical utility service meters and export the data to the campus metering network.

- Chilled Water: Flow, Supply Temp, Return Temp
- Steam Condensate: Flow
- Domestic Water: Flow

Mechanical utility service meters will be furnished and installed by Divisions 22 and 23. All conduit, wiring, terminations, programming and system integration is by Division 26. Coordinate mechanical meter connections and interface with Divisions 22 and 23.

Where mechanical utility service meters are indicated to report to the BMS system as well, coordinate conduit and wiring with Division 26. All terminations, programming and system integration is by Divisions 22 and 23:

All domestic water and Irrigation meters on campus must meet these standards:

- All meters 2" and above must be electromagnetic flow meter.
- All meters must provide a pulse output to communicate with the standardized SEL-735 electric meter.  
If the water meter only has 4 to 20 mA signal connection, then extra accessories will be required to communicate with the SEL-735.
- All meters must have a digital display on or near the meter. Meter to display reading in gallons.

- All meter digital displays must be under 5 feet from floor and provide a clear line a sight.
- 2" lines and above: McCrometer ultra mag meters (MX Ultra Mag series) or Onicon (F -3200 series)
- 1-1/2" lines or smaller: Sensus meter (T2 series) or Niagara (221 series)

## **33 10 00 Water Utilities**

### **Water Systems**

The water systems at the University of Idaho include domestic, reclaimed, chilled water, sewer, and storm water. The university operates its own water system on the Moscow campus, with two deep aquifer wells for domestic water and three shallow wells for research applications and outlying facilities. The reclaimed water system relieves pressure on the aquifer by converting wastewater from the City of Moscow water treatment facility into non-potable irrigation water. Sixty percent of the water use on campus is for domestic and research purposes, while the other forty percent is reclaimed water.

There are approximately eight (8) points of interconnection between the UI water system and the City of Moscow water system. These are normally closed but may be opened to provide backup for either system in an emergency.

U of I Facilities Maintenance and Operations has adopted the American Water Works Association (AWWA) Manual. All work on the campus water system or any backflow prevention requirements will be in accordance with the AWWA Manual.

All new work or modifications to the campus water systems shall be coordinated with and approved by the McKinstry Water Systems Manager.

The Consultant is required to obtain design approval and permits from Idaho Department of Environmental Quality (DEQ), US Environmental Protection Agency (EPA), and the City of Moscow for water systems (domestic water, sanitary sewer, storm sewer, reclaimed water).

### **Service to Buildings**

The building may be serviced by a single domestic water line. Once inside, the service can be split into a domestic water service, and a fire protection water service. Two reduced-pressure (RP) backflow preventers must be installed in a parallel assembly on both the domestic water and fire protection building services. (Base specification on Watts backflow preventions devices.) Each water service should be provided with an independent shut-off valve to facilitate maintenance on one system without shutting down the other. Verify requirements with UI Water Systems Manager and UI Plumbing Shop.

### **Fire Hydrants**

The number and location of all fire hydrants shall be coordinated with the McKinstry Water Systems Manager, the State of Idaho Deputy Fire Marshal and the Moscow Fire Department.

All fire hydrants shall be Waterous Pacer by American Flow Control. Provide a front hose quick connect.

All fire hydrants connected to the UI water system utility shall be powder-coated gold. The most efficient method is to ship hydrants to P & R sandblasting in Moscow, Idaho, who will sandblast and powder-coat hydrants to UI standards.

Contractors may connect to UI fire hydrants for filling water trucks and for other high-volume uses. Such connections must be approved in advance by the McKinstry Water System Coordinator. Flushing may be required prior to making the connection. Any connection to a fire hydrant must be made through an approved, reduced-pressure (RP) backflow prevention device.

### **Pipe**

Unless labeled as ductile iron on the drawings, all domestic water pipe 4-inches and larger shall be Polyvinyl Chloride (PVC) pipe with push-on type joints conforming to AWWA C900, DR18.

Ductile iron pipe is required under all building footings, foundations and slabs. All water piping penetrating through foundation, slabs or walls must be link sealed.

Pipe called out as ductile iron shall conform to AWWA C110, Class 50.

Pipes shall be restrained by thrust blocks.

All electrical connections must be in an approved direct bury splice kit.

Tracer wire is required for all buried pipe. Tracer wire must terminate on the outside of valve boxes.

#### Chilled Water Piping (12" and smaller):

- Pipe: AWWA C900, Class 150, DR 18 PVC pipe
- Fittings: Ductile Iron, cement mortar lined per AWWA C110 and AWWA C153 with mechanical joint.
- Gaskets: ASTM F 477, elastomeric seals.
- Chilled Water piping in tunnels and buildings must be sch 40 ductile iron. See steam piping requirements.

#### PVC Chilled Water Piping (larger than 12"):

- Pipe: AWWA C905, Class 165, DR 25 PVC pipe
- Fittings: Ductile Iron, cement mortar lined per AWWA C110 and AWWA C153
- Gaskets: ASTM F 477, elastomeric seals.
- Chilled Water piping in tunnels and buildings must be sch 40 ductile iron. See steam piping requirements.

#### Reclaimed Water Piping:

- Reclaimed water pipe 4-inches and larger shall be PVC pipe with push-on type joints conforming to AWWA C900, DR18.
- Pipes shall be restrained by thrust blocks.
- Pipe shall be C900 "Purple" pipe designated for reclaimed water use.

#### Valves and Fittings – Chilled Water And Domestic Water

- 4" thru 12" pipe: GripRing fittings are not allowed on plastic pipe; use only MEGALUG or mechanical joints. GripRing is allowed on ductile iron pipe.
- Larger than 12" pipe: EBAA Iron Series 2000PV mechanical joint restraint at all fittings and valves.
- Thrust blocks at all fittings and valves
- Valves shall be resilient seat gate valves, 200 PSI working pressure, epoxy coated inside and out with non-rising stem suitable for buried installation.
- Valves shall be American Flow Control, Series 2500. All buried valves shall have a 2-inch operating nut.
- Valve boxes shall be ASTM Class 30 Gray Iron, Stamped "Water." E. Valve boxes must be rated domestic or better for hard surface areas. Import valve boxes will be allowed in landscape areas.
- Fittings shall be ductile iron, conforming to AWWA Standard C-110 or C-153. 2.3

#### **Testing**

All lines shall be hydrostatically pressure tested by the Contractor. The Contractor shall arrange to have appropriate inspectors and UI personnel present to conduct and observe the pressure tests.

All water mains and appurtenances shall be tested in sections of convenient length under a hydrostatic pressure equal to the larger of (1) one and one-half (1 1/2) times the local operating pressure or, (2) the local operating pressure plus surge pressure. In no case, shall the test pressure be less than two hundred (200) psi.

An initial pressure and leakage test shall be conducted as soon as possible, but not until sufficient backfill has been placed, or other effective means have been provided, to prevent the movement of the pipe.

## **Disinfection**

All water lines and appurtenances shall be disinfected and flushed by the Contractor according to Section 401, paragraph 3.9 of the ISPWC manual. The Contractor shall cooperate and coordinate with the McKinstry Water System Manager for this operation.

Should the initial treatment result in an unsatisfactory bacteriological test, the original chlorination procedure will be repeated by the Contractor until satisfactory results are obtained. Failure to get a satisfactory test shall be considered as failure of the Contractor to keep the pipe clean during construction, unless it can be established that proper chlorination of the main was not achieved. Re-chlorination of the main due to failure of the Contractor to keep the pipe clean during construction shall be at the Contractor's expense.

## **33 30 00 Sanitary Sewerage**

### **Permits**

Connection of any sanitary sewer lines to main branches operated by the City of Moscow will require a City of Moscow sewer tap connection permit and fee. Verify all locations of City of Moscow sewer branches with the McKinstry Water Systems Manager.

All sewer lines must be inspected by camera after installation to verify proper installation and cleaning of debris. The McKinstry Water Systems Manager shall witness the camera inspection or be provided with video before Owner acceptance.

## **33 40 00 Stormwater Utilities**

Storm Sewer piping and drainage shall conform to the applicable sections of the Idaho Standards for Public Works Construction (ISPWC), Section 601.

Storm sewer pipe, pressure or gravity pipe having less than two (2) feet of cover shall be Ductile Iron according to the requirements of AWWA C151; or PVC, meeting the requirements of AWWA C900. Gravity storm sewer pipe having more than three (3) feet of cover may be PVC, conforming to ASTM D3034, SDR 35, with push-on joints.

All stormwater lines must be inspected by camera after installation to verify proper installation and cleaning of debris. The UI Water Systems Manager shall witness the camera inspection or be provided with video before Owner acceptance.

Catch basins will have approved traffic rated lids or grates in all locations.

The contractor will be required to monitor site erosion and dewatering systems to ensure that no sediment-laden runoff is entering into existing catch basins or into the campus stormwater drainage system. Provide sediment traps, protection and silt-fencing as required. Refer to "Division 31 – Earthwork" and "Division 32 – Site Improvements" for additional information.

## **33 50 00 Gas Utilities**

Natural gas for the university's energy plant is purchased directly from IGI Resources. Gas is primarily used as a backup for the wood chip fuel during boiler maintenance or periods of high energy demands.

Natural gas is also purchased from Avista Utilities for buildings not served by the energy plant and/or for accessory uses around campus (i.e., emergency generators). Avista Utilities maintains the gas lines up to the building service meter and is the governing authority for natural gas piping installation in UI buildings. The contractor shall coordinate all testing and inspection through Avista.

## **33 60 00 Steam Utilities**

Steam, chilled water, and compressed air are produced at the District Energy Plant on campus.

All new work or modifications to the steam or chilled water distribution systems shall be coordinated with and approved by the McKinstry utility partner.

### **Tunnels and Utilidors**

All new steam lines must be run in concrete service tunnels or utilidors. Service tunnels of at least 6'-0" in height are preferred. Direct-buried steam lines are not allowed unless otherwise authorized by Utilities and Engineering Services.

### **General**

Slope steam condensate piping 1 inch per 40 feet (0.25 %) towards the condensate receiver and steam pipe 1 inch per 20 feet towards the steam boiler or steam trap. Provide drip trap assembly at low points and before control valves. Run condensate lines from trap to nearest condensate receiver. Provide loop vents over trapped sections.

Where condensate is required to be pumped, any pipes filled with pumped condensate (sloped towards pump station) shall be stainless steel to mitigate corrosion.

### **Low Pressure Steam Piping and Steam Vent Piping**

Pipe up to and including 2 inch:

Steel: ASTM A53; schedule 40; black; ASTM A234 forged steel fittings; Class 125; threaded joints

Pipe over 2 inch:

Steel: ASTM A53; Schedule 40; black; ASTM A234 forged steel fittings; Class 150; welding type

### **Low Pressure Steam Condensate Piping**

Pipe up to and including 2 inch:

Steel: ASTM A53; schedule 80; black; ASTM A234 forged steel fittings; Class 125; threaded joints  
(Provide schedule 40, 304SS condensate piping where required.)

Pipe over 2 inch:

Steel: ASTM A53; Schedule 80; black; ASTM A234 forged steel fittings; Class 150; welding type  
(Provide schedule 40, 304SS condensate piping where required.)

### **Medium Pressure Steam and Steam Condensate Piping**

Pipe up to and including 2 inch:

Steel: ASTM A53; schedule 80; black; ASTM A234 forged steel fittings; Class 300; threaded joints  
(Provide schedule 40, 304SS condensate piping where required)

Pipe over 2 inch:

Steel: ASTM A53; Schedule 80; black; ASTM A234 forged steel fittings; Class 300; welding type

### **Gaskets**

Manufacturers:

Flexitallic

Construction:

Spiral wound metal gaskets suitable for joint type, system temperature and pressure

## **Valves**

All valves must be steam rated.

### Manufacturers:

- Hammond
- Milwaukee
- Nibco
- Stockham

### Gate Valves - Low and Medium Pressure Service:

Up to and including 2 inch: MSS-SP80; bronze body; bronze trim; rising stem; union bonnet; solid wedge disc; gland packed; malleable or ductile iron hand wheel; threaded ends; Class 125 for 80 psi and below; Class 150 for systems greater than 80 psi.

Over 2 inch: MSS-SP70; iron body; bronze trim; OS and Y pattern; bolted bonnet; solid wedge disc; gland packed cast iron handwheel; flanged ends; Class 125 for 80 psi and below; Class 250 for systems greater than 80 psi.

### Globe Valves - Low and Medium Pressure Service:

Up to and including 2 inch: MSS-SP80; bronze body; bronze trim; solid wedge disc; malleable or ductile iron hand wheel; threaded ends; Class 125 for 80 psi and below; Class 150 for systems greater than 80 psi.

Over 2 inch: MSS-SP70; iron body; bronze trim; OS and Y pattern; bolted bonnet; solid wedge disc; gland packed cast iron handwheel; flanged ends; Class 125 for 80 psi and below; Class 250 for systems greater than 80 psi.

### Swing Check Valves - Low and Medium Pressure Service

Up to and including 2 inch: MSS-SP80; bronze body; bronze trim; stainless steel pin; bronze seat and Teflon disc; threaded ends; Class 125 for 80 psi and below; Class 150 for systems greater than 80 psi.

Over 2 inch: Iron body, bronze trim, stainless steel pin; renewable disc and seat; flanged ends; Class 125 for 80 psi and below; Class 250 for systems greater than 80 psi.

## **Valve Selection**

Gate Valves: Infrequent (used only for equipment replacement or other, non-scheduled maintenance) shut-off service and to isolate equipment, parts of systems or vertical risers.

Globe Valves: Frequent (used as part of a routine maintenance program or for seasonal changes in system operation) shut-off, throttling and bypass service including manual flow control services

## **Steam Traps**

### Manufacturers:

TLV (no substitutions)

## **33 70 00 Electrical Utilities**

### **General**

The University of Idaho purchases electricity from Avista Utilities via two metered feeds at the edge of campus, which is then distributed through the electrical distribution utility and 13,200V distribution system managed by the utility concessionaire.

All medium voltage connections (600V and under) will be completed by the contractor and that work shall be defined and included in the construction documents. All 13,200V connections will be contracted separately by the University of Idaho to one of the pre-qualified electrical contractors capable of doing that work.

Pre-Qualified 13,200V Installers:

1. Wilson Construction Company, Shop E. 2121 Springfield, Spokane WA, 99292.
2. International Line Builders, 2015 Delta Drive, Nampa, ID 83687
3. Arc Electric, 5524 N Julia St, Spokane, WA 99217
4. Colvico Electric, 2812 North Pittsburg Street, Spokane, WA 99207
5. Power City, 3327 E. Olive Avenue, Spokane, WA 99202

The UI PM and DP are required to account for Owner contracted 13,200V work in the project budget and project scheduling.

**Standards**

All underground electrical utility work on the UI campus shall adhere to the “Electrical Distribution Underground Construction Standards”, current edition, as published by Avista, Distribution Design, P.O. Box 3727, Spokane, WA 99220-3727.

All overhead electrical utility work on the UI campus shall adhere to the “Electrical Distribution Overhead Construction Standards”, current edition, as published by Avista, Distribution Design, P.O. Box 3727, Spokane, WA 99220-3727.

**Buried Ductbank**

Provide underground warning tape; 4” wide plastic tape, detectable type, colored red with suitable warning legend describing buried electrical lines.

Exterior buried conduit and ductbank containing transformer primary and secondary circuits of 208V or higher shall be encased in concrete.

Exterior buried conduit and ductbank containing medium voltage circuits (600V to 25,000V) shall be encased in RED concrete.

Install duct with minimum slope of 4 inches per 100 feet (0.33 percent). Slope duct away from building entrances.

Provide minimum 3” concrete cover at bottom, top, and sides of ductbank

**Shut Downs**

All electrical service disruptions and shut downs must be coordinated in advance with the UI CM and the UI Electrical Shop. Shut downs that will impact occupied spaces, adjacent buildings, or campus neighborhoods must be coordinated **at least three weeks in advance**. Many buildings on campus contain on-going research that can be critically impacted by a prolonged electrical outage. The UI requires time to make alternate accommodations as may be required. All major electrical shut downs will typically be scheduled to occur early in the morning on weekends to minimize impacts to the campus.

**Safety Program**

The UI has adopted a Hazardous Energy Control (Lock Out/Tag Out) program. A copy of the program will be provided to the contractor on each project. The contractor must comply with this program. If the contractor has their own Lock Out/Tag Out program in place, this program may be submitted to the UI for review and approval.

## **33 80 00      Communication Utilities**

Refer also to "Division 27 – Communications" for additional information regarding UI Structured Cabling standards. Communication Utilities are not part of the utility concessionaire agreement and remain managed by the University of Idaho.

### **Trenching**

Provide a minimum of 24" cover over buried communication conduit and/or ductbank.

### **Conduit / Ductbank**

Minimum 3" HDPE: JM Eagle Schedule 80 or UI OIT approved equal

The number and size of conduits shall be coordinated with UI OIT and/or the communications utility.

Multiple groups of conduits (ductbank) and/or main utility fiber feeds to campus shall be encased in concrete at the direction of UI OIT.

Provide a buried tracer wire above all conduit runs or ductbank. Terminate in each handhole using triple nut anchorage. Provide 12-gauge solid copper with thermoplastic insulation.

### **Handholes**

Handholes shall be a minimum of 24"x36" and should be located within 5' of buildings. Handholes shall be Hubbell Power Systems PG2436BA24 or approved equal. Lids to be labeled: "COMMUNICATION".

Larger vaults may be required at ductbanks with multiple communication lines and/or where fiber runs require wider sweeps and/or more slack cable. Coordinate all requirements with OIT.



# APPENDIX A

## SAMPLE FORMS AND DOCUMENTS

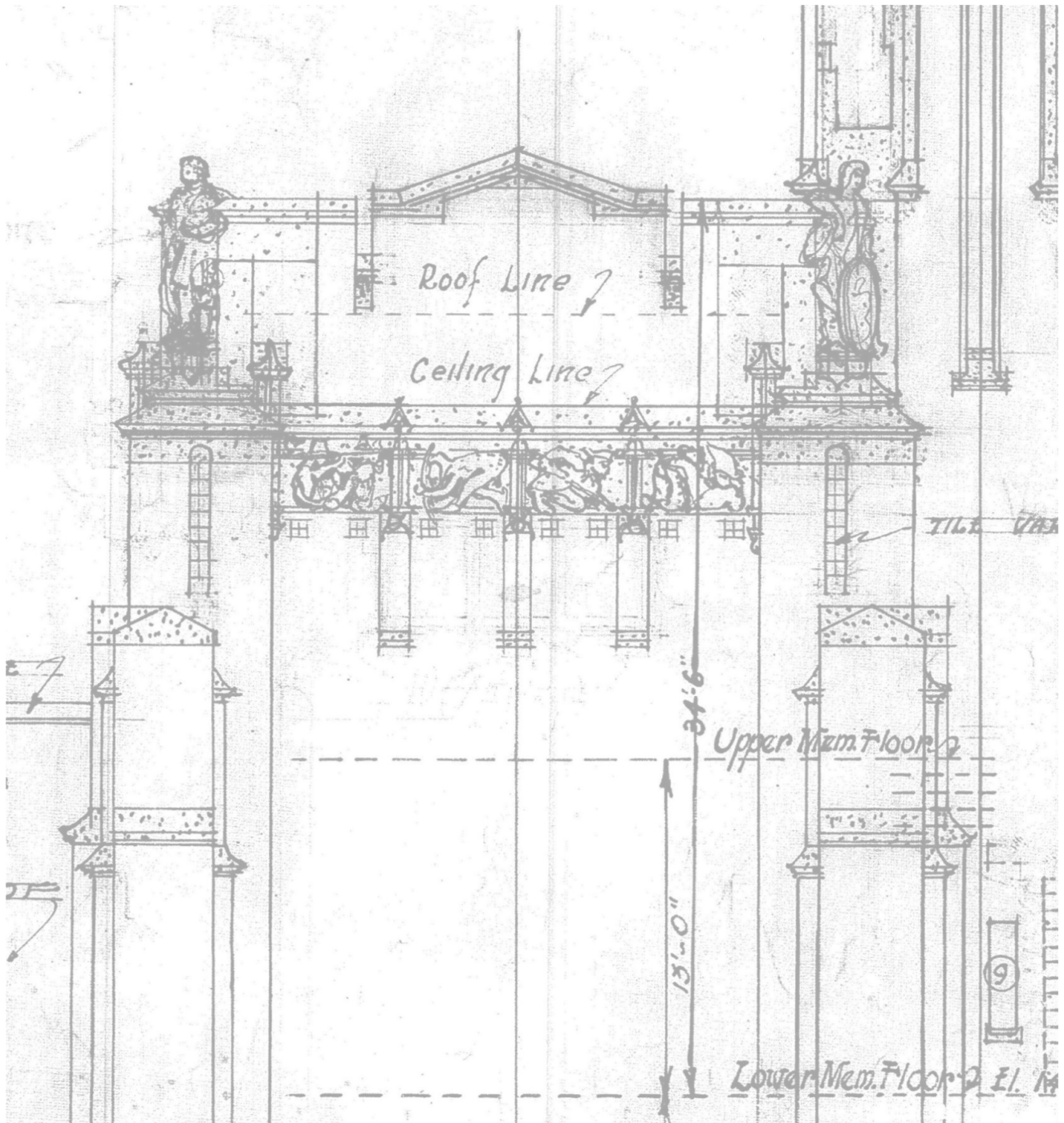

**(SAMPLE)**  
**AMENDMENTS TO STANDARD FORM OF AGREEMENT**  
**BETWEEN OWNER AND ARCHITECT**

This document supplements, modifies, changes, and adds to the STANDARD FORM OF AGREEMENT BETWEEN OWNER AND ARCHITECT, AIA Document B101 (2017 Edition) for the Project entitled “**(Insert Project Name Here)**”. The Articles and Paragraphs set forth in these Amendments correspond to the Articles and Paragraphs in the Agreement. Where any Article, Paragraph, Subparagraph or Clause of the Agreement is modified or deleted by these Amendments, the unaltered provisions of the Article, Paragraph, Subparagraph or Clause remain in effect.

**At Page 1:**

- (a) Delete "Architect's client identified as the".
- (b) Insert "and" between "legal status" and "address" and delete "and other information" in the two (2) locations where it appears.

**ARTICLE 2**  
**ARCHITECT'S RESPONSIBILITIES**

- 2.2** Delete this paragraph and substitute therefor the following:

Services provided by the Architect will be performed in a manner consistent with that degree of care and skill ordinarily exercised by members of the same profession currently practicing under similar circumstances in the Moscow, Idaho, region. Upon request of the Owner, the Architect shall submit for the approval of the Owner a schedule for the performance of the Architect's services which, upon written agreement of the Owner and Architect, may be adjusted as the Project proceeds, and shall include allowances for periods of time required for review by the Owner and for approval of submissions by authorities having jurisdiction over the Project. Time limits established by this schedule approved by the Owner shall not, except for reasonable cause, be exceeded by the Architect or Owner.

- 2.3** Delete this paragraph and substitute therefor the following:

The Architect shall designate in writing one person who shall be the Project Architect and have express authority to bind the Architect on all matters ("Architect's Representative"). Prior to the initial appointment and any substitute appointment of the Architect's Representative, the Architect shall identify the proposed Architect's Representative to the Owner and obtain the Owner's approval. The Owner has the right to reject any proposed Architect's Representative, or to require the Architect to remove any existing Architect's Representative and appoint a substitute Architect's Representative. Upon reasonable notice to the Architect's Representative, the Owner may require the Architect's Representative to attend such meetings as the Owner may determine. The services of the Project Architect are included within the Basic Services of the Architect, and are not Additional Services.

- 2.5** Delete the sentence, "If any of the requirements set forth below are in addition to the types and limits the Architect normally maintains, the Owner shall pay the architect as set forth in Section 11.9."

- 2.5.1** Delete this paragraph and substitute therefor the following:

**COMPREHENSIVE GENERAL LIABILITY.** The Architect shall maintain such comprehensive general liability insurance (including broad-form contractual liability and completed operations, explosion, collapse and underground hazards) in the amount of one million dollars (\$1,000,000) covering personal injury, bodily injury, and property damage.

- 2.5.2** Delete this paragraph and substitute therefor the following:

**COMPREHENSIVE AUTOMOBILE LIABILITY INSURANCE.** The Architect shall maintain Comprehensive Automobile Liability Insurance, including hired and non-owned vehicles, if any, in the amount of one million dollars (\$1,000,000) covering personal injury, bodily injury, and property damage.

**2.5.4** Delete this paragraph and substitute therefor the following:

WORKER'S COMPENSATION. The Architect shall maintain workers' compensation insurance in the amount of the statutory maximum and employer's liability insurance of at least five hundred thousand (\$500,000) and comply in all respects with regulations concerning the employment of labor required by any duly constituted authority having legal jurisdiction over the area in which the work is performed.

**2.5.5** Delete this paragraph and substitute therefor the following:

PROFESSIONAL LIABILITY. The Architect shall maintain professional liability (errors and omissions) insurance in the amount of one million dollars (\$1,000,000) with all coverage retroactive to the earlier of the date of this Agreement or the commencement of Architect's services in relation to the Project. Said insurance shall cover personal injury, bodily injury, and property damage. Such coverage shall be maintained for a period of three (3) years after the date of final payment.

**2.5.6** Delete this paragraph and substitute therefor the following:

FORCE AND EFFECT. All insurance required by this Agreement shall be maintained in full force and effect in a company or companies reasonably satisfactory to the Owner and shall be maintained at the Architect's expense. All insurance except Professional Liability shall name "the State of Idaho and The Regents of the University of Idaho and their agents, employees, and assigns" as additional insureds and shall contain a clause requiring written notice to the Owner thirty (30) days in advance of the cancellation, non-renewal, or material modification of said insurance as evidenced by return receipt of United States certified mail. Certificates of insurance and additional insured endorsements shall be supplied contemporaneously with the execution and delivery of this Agreement. The certificates and endorsements shall evidence compliance with all provisions of Paragraph 12.1. Copies of actual insurance policies shall be provided upon request of Owner.

**2.5.8** Delete this paragraph and substitute therefor the following:

NOTICE. The Architect and the Architect's Consultant shall: (a) notify the Owner and the Owner's insurers in writing as soon as practicable after notice of an injury or a claim is received; (b) cooperate completely with the Owner and/or the Owner's insurers in the defense of such injury or claim; and (c) take no steps (such as admission of liability) which will prejudice the defense of the claim or otherwise prevent the Owner from protecting the Owner's interests.

**2.6** Add new paragraph 2.6:

CONFIRMATION NOTICES: The Architect shall provide a written record of all meetings, discussions, verbal directions, telephone conversations, etc., attended by the Architect or his representatives on significant matters relating to the successful completion of the Project. These records shall fully identify all participating personnel, subjects discussed, and any conclusions reached. The Architect shall forward to the Owner copies of the conference minutes. Forwarding shall be done as soon as possible, but not later than five working days after the conference. Distribution of these minutes will be made by the Owner.

### ARTICLE 3

#### SCOPE OF ARCHITECT'S BASIC SERVICES

- 3.2.4** (a) Delete "Owner's approval," and insert in lieu thereof "for submission to and review by the Owner,"  
(b) Delete the period at the end of the sentence and insert the following in lieu thereof: "; provided, that the Owner's review of the Architect's design documents shall not be for the purpose of determining the accuracy, adequacy or completeness of such documents and shall not alter the Architect's responsibilities hereunder with respect to such documents."

- 3.3.1** (a) In the first sentence delete the words "approval" and insert in lieu thereof "review"; and,  
(b) Delete the period at the end of the sentence and insert the following in lieu thereof: "; provided, that the Owner's review of the Architect's design documents shall not be for the purpose of determining the accuracy, adequacy or completeness of such documents and shall not alter the Architect's responsibilities hereunder with respect to such

documents. "

**3.3.4** Add a new paragraph 3.3.4:

3.3.4.1 When appropriate, drawings at the design development level shall include:

1. Dimensional floor plans with functional arrangement of all areas, including exits and utility spaces properly related to exterior access roads, parking, service areas, etc. Special emphasis shall be placed on indicated items involving special design and/or deviations from accepted standards.
2. Mechanical equipment, heating, and plumbing drawings shall provide for the location and space requirements for all major items of mechanical equipment and shall show major ductwork and plumbing runs with sizing.
3. Electrical drawings shall provide for service entrance and distribution arrangement. Cable sizes and the switch and panelboard descriptions are required. Proposed switches, fixtures, and outlets shall be included.
4. Elevations shall be included as required to describe the work in this design.
5. A sufficient number of sections shall be provided as necessary to describe the design.
6. Typical wall sections to include materials, dimensions, and thickness of facing materials shall be furnished.
7. Roof Plans shall be included as necessary.
8. Clear indication of all required controlling dimensions shall be shown.
9. Sufficient detail shall be shown to clearly indicate that mechanical, plumbing and HVAC systems have been provided for.

**3.3.6** Add a new paragraph 3.3.6 as follows:

COMPLIANCE: Documents produced by the Architect in relation to the Project shall comply with applicable laws, statutes, ordinances, codes, orders, rules, and regulations. The Architect will coordinate and reconcile all major building code and fire apparatus access issues with the Division of Building Safety, the State Fire Marshall, and all Authorities Having Jurisdiction prior to the completion of the Design Development Phase.

- 3.4.1** (a) Delete "approval" at the end of the first sentence and insert in lieu thereof " review"; and  
(b) Delete the period at the end of the first sentence and insert the following: "; provided, that the Owner's review of the Architect's design documents shall not be for the purpose of determining the accuracy, adequacy or completeness of such documents and shall not alter the Architect's responsibilities hereunder with respect to such documents."

**3.5.1** In the second sentence delete "Following the Owner's approval of the Construction Documents".

**3.6.4.6** Add a new paragraph 3.6.4.6 as follows:

CODE REVIEW: The Architect shall prepare drawings and specifications for a preliminary code review by the Division of Building Safety and authorities having jurisdiction, and shall participate in the code review. The Architect shall coordinate the code review with the Contractor.

## **ARTICLE 5 OWNER'S RESPONSIBILITIES**

**5.1** Delete this paragraph and substitute therefor the following: "The Owner shall provide such timely information as may be reasonably necessary for the Architect to perform Architect's services."

**5.3** In the first sentence, delete "act on the Owner's behalf" and insert in lieu thereof "represent the Owner".

**5.16** A new paragraph 5.16 is added as follows:

The Owner may have furnished some information regarding the physical characteristics of utility locations for the Project site including, possibly, geotechnical surveys and above ground site surveys. The Owner does not assume

any responsibility regarding any surveys, test borings, or other investigations regarding the site, and makes no warranty or guaranty regarding the site conditions. The Architect shall make such site investigations as the Architect deems necessary and shall make available to the Owner and Contractor all reports of such site investigations.

**5.17** A new paragraph 5.17 is added as follows:

Architectural and Engineering Services, University of Idaho, Moscow, Idaho is responsible for the administration of this Agreement with the Architect. No change shall be made in the provisions of the contract without written authorization by the Department of Architectural and Engineering Services.

## **ARTICLE 7 COPYRIGHTS AND LICENSES, SPECIFICATIONS AND OTHER DOCUMENTS**

In the title, insert "DRAWINGS, SPECIFICATIONS AND OTHER DOCUMENTS".

**7.2** Delete this paragraph and substitute therefor the following:

The Drawings, Specifications and other documents prepared by the Architect for this Project are instruments of the Architect's service for use solely with respect to the Project, and the Architect shall be deemed the author of these documents and shall retain all common law, statutory and other reserved rights, including the copyright. The Owner shall be permitted to retain copies, including reproducible copies, of the Architect's Drawings, Specifications and other documents for information and reference in connection with the Owner's use and occupancy of the Project. Notwithstanding the foregoing, the Owner shall have a non-exclusive license of indefinite duration to use the Architect's Drawings, Specifications and other documents for additions to this Project, completion of this Project by others, and other university purposes. Use of said Drawings, Specifications and other documents for additions to this Project or for other University purpose (excluding completion of this Project by others) shall be at the Owner's sole risk, and the Owner shall indemnify and hold harmless the Architect from liabilities arising from the Owner's use thereof with respect to additions to this project or other university purposes (excluding completion of this Project by others).

**7.3** This paragraph is deleted.

**7.3.1** This paragraph is deleted.

**7.4** This paragraph is deleted.

## **ARTICLE 8 CLAIMS AND DISPUTES**

Article 8 is deleted in its entirety and a new Article 8 is substituted therefor as follows:

**8.1** MEDIATION. Disputes arising between the Owner, Architect, Contractor, Subcontractor or Supplier, under the Contract Documents, this Agreement or relating to or arising from the Project may, at the sole discretion of the Owner, be mediated as follows:

**8.1.1** APPOINTMENT. If Owner decides that a dispute should be mediated, Owner, Architect and Contractor shall mutually select a mediator ("Mediator").

**8.1.2** REFERRAL OF DISPUTE. If the Owner, Architect or Contractor, with or without the informal assistance of the Mediator, are unable to resolve any dispute, the Owner may refer the dispute to the Mediator, in writing, for resolution pursuant to the methods and procedures then in effect. The Architect consents to joinder to any mediation involving the Owner and Contractor and the Contractor consents to joinder to any mediation involving the Owner and Architect.

**8.1.3** ADMINISTRATIVE SESSION. Upon the reference of a dispute by the Owner, the Mediator shall conduct an initial administrative conference with the parties to establish a plan of action for the review and analysis of the dispute and the agenda and schedule for undertaking the process.

- 8.1.4 DISPUTE RESOLUTION SERVICES.** The services to be performed by the Mediator, depending upon the nature of the dispute, shall generally include (i) identification, receipt and organization of relevant documentation; (ii) preliminary issue identification, review and evaluation; (iii) interviews with Project personnel and other necessary individuals who are knowledgeable about the problem and issues in dispute; (iv) joint meetings with the Owner, Architect and/or Contractor to present key issues; (v) additional document acquisition, interviews, preliminary issue evaluation; (vi) meeting with the Owner, Architect and/or Contractor to present a draft report of the Mediator's assessment of the dispute including a range of recoverable damages; (vii) review of submissions of clarifications and rebuttal from the parties in preparation of a final report; and (viii) meeting with the parties for presentation of the Mediator's final report and for one or more settlement conferences.
- 8.1.5 INFORMAL RESOLUTION.** During the time any dispute is pending, the Mediator may meet informally with any party in an effort to achieve agreement on any aspect of the dispute.
- 8.1.6 FINAL REPORT.** As part of the evaluation performed by the Mediator in connection with any dispute, the Mediator will issue a final written report within 5 business days after referral of the dispute to the Mediator by any party, including guidance to the parties on measures that could be successful in eliminating similar disputes from occurring in the future.
- 8.1.7 COMPENSATION.** The Owner, Architect and Contractor shall share the Mediator's fees and costs equally. Each party shall be responsible for its own attorneys fees and costs, if any, related to the mediation process.
- 8.2 RESOLUTION OF CLAIMS AND DISPUTES -- LITIGATION OR ARBITRATION.** If the dispute cannot be resolved pursuant to Paragraph 8.1, then the dispute shall be decided as follows: (a) unless elected by Owner, by a court of competent jurisdiction located in Latah County; (b) if elected by the Owner, at the Owner's sole discretion, by arbitration (to be conducted at a location selected by the Owner) pursuant to the rules of the American Arbitration Association. The Architect consents to joinder to any arbitration involving the Owner and Contractor and the Contractor consents to joinder to any arbitration involving the Owner and Architect.
- 8.3 ATTORNEY FEES.** Except as provided in paragraph 8.1.7, in the event a party to this Agreement brings any action or suit against another party to this Agreement by reason of any breach of any of the covenants, agreements, or provisions on the part of the other party arising out of this Agreement, then in that event the prevailing party shall be entitled to have and recover from the other party all costs and expenses of the action or suit, including reasonable attorney fees, at trial and on appeal. A party shall be deemed a prevailing party only if it prevails on the main issue in the action or suit and only if it prevails substantially to the extent of its original contention.

## **ARTICLE 9 TERMINATION, SUSPENSION**

- 9.1** This paragraph is deleted and a new paragraph 9.1 is substituted therefor as follows:

Either party may terminate this Agreement at any time for any or no reason by providing written notice of such termination. Such termination shall not limit any right of remedy available to the Owner or Architect at law or in equity under this Agreement, including, without limitation, the right to collect damages and seek injunctive relief.

- 9.2** In the first sentence, insert "through no fault of the Architect," immediately following "Project".

In the second sentence, delete "expenses" and insert in lieu thereof "direct expenses reasonably".

- 9.10** A new paragraph 9.10 is added as follows:

If the Owner fails to make payment when due for services and expenses, the Architect may, upon fourteen days written notice to the Owner, suspend performance of services under this Agreement. Unless payment in full is received by the Architect within fourteen days after the notice is received by the Owner, the suspension shall take effect without further notice. In the event of a suspension of services, the Architect shall not have liability to the Owner for delay or damage caused the Owner because of such suspension of services.

## **ARTICLE 10**

## MISCELLANEOUS PROVISIONS

**10.4** At the end of this paragraph, a new sentence is added as follows: "The Owner is not obligated, required or responsible for determining whether the Work is constructed in accordance with the Plans and Specifications in a good and workmanlike manner and in conformity with good construction and engineering practice."

**10.5** This paragraph is deleted and a new paragraph 10.5 substituted therefore as follows:

Except as noted in Section 2.2, nothing contained in this Agreement shall create a contractual relationship with or a cause of action in favor of a third party against either the Owner or Architect.

**10.6** This paragraph is deleted and a new paragraph 10.6 substituted therefore as follows:

Unless otherwise provided in this Agreement, the Architect and Architect's consultants shall have no responsibility for the discovery, presence, handling, removal or disposal of or exposure of persons to hazardous materials in any form at the Project site, including, but not limited to, asbestos, asbestos products, polychlorinated biphenyl (PCB), or other toxic substances.

**10.7** In the first sentence, delete the first word "The" and insert ", Subject to the Owner's prior review and written approval thereof, the".

In the last sentence, delete "shall" and insert in lieu thereof "may, in its sole discretion,".

**10.10** A new paragraph 10.10 is added as follows:

NOTICE. Any notice under this Agreement shall be in writing and shall be delivered in person or by public or private courier service (including U.S. Postal Service Express Mail) or certified mail with return receipt requested or by facsimile. All notices shall be addressed to the parties at the following addresses or at such other addresses as the parties may from time to time direct in writing:

OWNER:                                       The Regents of the University of Idaho  
  Vice-President of Finance & Administration  
  University of Idaho  
  Moscow, ID 83844-3168  
  Phone: (208) 885-6174  
  Fax: (208) 885-5504

ARCHITECT:                                   (Name of Design Professional Representative)  
  (Name of Design Professional Company)  
  (address).  
  (city, state, zip)  
  Phone:  
  Fax:

Any notice shall be deemed to have been given on the earlier of (a) actual delivery or refusal to accept delivery, (b) the date of mailing of certified mail, or (c) the day facsimile delivery is verified. Actual notice, however, and from whomever received, shall always be effective.

**10.11** A new paragraph 10.11 is added as follows:

DUPLICATE ORIGINALS: This Agreement shall be signed with two originals. Owner, Architect and Contractor shall each retain an original.

**10.12** A new paragraph 10.12 is added as follows:

CONTRACT CONSTRUCTION. If any term or provision of this Agreement shall, to any extent, be determined by a court of competent jurisdiction to be invalid or unenforceable, the remainder of this Agreement shall not be affected

thereby, and each term and provision of this Agreement shall be valid and be enforceable to the fullest extent permitted by law. If any provision of this Agreement of capable of two constructions, one of which would render the provision void and the other of which would render the provision valid, the provision shall have the meaning which renders it valid.

**10.13** A new paragraph 10.13 is added as follows:

PERFORMANCE EXCUSED. Any prevention, delay or stoppage due to acts of God, inability to obtain labor or materials or reasonable substitutes therefore, governmental restrictions, governmental regulations, governmental controls, enemy or hostile governmental action, civil commotion, fire or other casualty, and other causes, except strikes, lockouts, or labor disputes, beyond the reasonable control of the party obligated to perform (except for financial ability) shall excuse the performance, except for the payment of money, by such party for a period equal to any such prevention, delay or stoppage.

**10.14** A new paragraph 10.14 is added as follows:

RELATIONSHIP OF PARTIES. Nothing contained in this Agreement shall be construed as creating a joint venture, partnership, employment or agency relationship between the parties. The Architect is acting at all times as an independent contractor.

**10.15** A new paragraph 10.15 is added as follows:

DISCRIMINATION. The Architect agrees not to discriminate against any employee or applicant for employment in the performance of this Agreement with respect to tenure, terms, conditions or privileges of employment, or any matter directly or indirectly relating to employment because of race, sex, color, religion, national origin, disability, ancestry or status as a Vietnam veteran. Breach of this Paragraph shall be regarded as a material breach of this Agreement.

**10.16** A new paragraph 10.16 is added as follows:

CONFIDENTIALITY. The parties agree that the terms and conditions of this Agreement shall be held in confidence except as required by or for applicable disclosure and other laws and regulations, financing sources, enforcement of the Agreement, mergers and acquisitions, or as otherwise mutually agreed by the parties, such agreement not to be withheld unreasonably.

**10.17** A new paragraph 10.17 is added as follows:

APPROVAL. This Agreement may be subject to approval by the Regents of the University of Idaho or the Executive Director of the Idaho Board of Education. If the Agreement is subject to such approval and such approval is not granted, this Agreement shall be void and neither party shall have any further obligations or liabilities hereunder.

**10.18** A new paragraph 10.18 is added as follows:

USE OF NAME. Excepted as provided for elsewhere in this Agreement, the Architect shall not, without the Owner's express written consent in each case, which consent will not be unreasonably withheld, use any name, trade name, trademark, or other designation of the Owner (including contraction, abbreviation or simulation) in advertising, publicity, promotional, or any other activities or context.

**10.19** A new paragraph 10.19 is added as follows:

TIME OF ESSENCE. Except as otherwise mentioned herein, all times provided for in this Agreement, or in any other document executed hereunder, for the performance of any act will be strictly construed, time being of the essence.

## **ARTICLE 11 COMPENSATION**

**11.9** This paragraph is deleted.



**ARTICLE 12  
SPECIAL TERMS AND CONDITIONS**

**12.1** A new paragraph 12.1 is added as follows

INDEMNITY. The Architect and the Architect's Consultant shall indemnify and hold the State of Idaho and Owner and their employees, and assigns harmless from and against claims, damages, and liabilities (including reasonable attorneys' fees) that may be suffered or incurred and that arise as a direct result of and/or which are caused by the Architect or the Architect's work.

**12.2** A new paragraph 12.3 is added as follows:

FINANCIAL INFORMATION. The Architect represents and warrants to the Owner the following: (a) that Architect is financially solvent, able to pay its debts as they mature, and possessed of sufficient working capital to complete the services required and perform its obligations; (b) that Architect is able to furnish any and all of the plant, tools, materials, supplies, equipment, and labor required to complete the required services and obligations and has sufficient experience and competence to do so; (c) that Architect is authorized to do business in Idaho and properly licensed by all necessary governmental and public and quasi-public authorities having jurisdiction over it and the required services and the Project itself; (d) that Architect's execution of this Agreement and its performance thereof are within its duly authorized powers; and (e) that Architect has visited the Project, familiarized itself with the local conditions under which the required services are to be performed. Architect agrees that the representations and warranties contained in this Paragraph shall survive the execution and delivery of this Agreement.

**OWNER:**

THE REGENTS OF THE UNIVERSITY OF IDAHO  
Moscow, ID 83844

Dated: \_\_\_\_\_

Signature: \_\_\_\_\_  
Brian Foisy, VP, Finance and Administration

**ARCHITECT:**

(Design Professional Name)  
(address)  
(city, state, zip)

Dated: \_\_\_\_\_

Signature: \_\_\_\_\_  
(Design Professional Signatory Authority)

**END OF STANDARD AMENDMENTS TO AIA B101 – 2017**

May 1, 2018

(Insert Contractor Name)  
Address, City, State, Zip  
Phone Number; E-mail

## Facilities

875 Perimeter Drive MS 2281  
Moscow ID 83844-2281

Phone: 208-885-6246  
facilities@uidaho.edu

**RE: (SAMPLE) LETTER CONTRACT**  
(Insert Contractor Name)  
(UI CP Number); (Work Order Number)  
University of Idaho, Moscow, Idaho

This is to inform you that your fees for services for the above referenced project in the amount listed below has been accepted by the project manager. Therefore, Architectural & Engineering Services authorizes you to perform the necessary services for the project.

This document is your **NOTICE TO PROCEED** per the following conditions:

**Please provide the following documents:**

Certificate of Liability Insurance (see Attachment "B"); Idaho Unemployment Insurance and Workmen's Compensation and State of Idaho W-9 Tax Identification (On file).

**You will be responsible for:**

Providing Contracting Services as described in Attachment "A".

**Schedule:**

The Contractor shall perform basic and any additional services, as expeditiously as is consistent with professional skill, care and orderly progression of the work.

**Compensation:**

Compensation shall be provided on a time and material basis **NOT TO EXCEED (Insert contract amount in words) (\$ insert contract amount in numbers)** unless authorized in writing by the Owner.

Should any additional service be deemed necessary beyond those represented, they will be authorized in writing by the Owner as an amendment to this Agreement.

*For payment send the invoice to: Terri Bencotter; University of Idaho; Architectural & Engineering Services; Moscow, Idaho 83844-2281 (Payment Application form is attached and must be used for payment processing).*

**Project Coordination:**

The contact person for coordinating the work for the project is (Project Manager), AES, University of Idaho, Moscow, Idaho (208-885-5495).

If these terms are acceptable, please sign one copy of this letter and return it as soon as possible. Keep the other copy for your information and file. We look forward to working with you in the most expeditious manner.

Sincerely,

Raymond Pankopf, NCARB  
Director, Architectural & Engineering Services

(Insert Contractor Name) Acceptance:

By: \_\_\_\_\_  
(Insert Contractor Name)

Date: \_\_\_\_\_

**Attachments**

c: Project File, AES Read

(SAMPLE) ABBREVIATED BID PROPOSAL

**Project Name**

**Project Location or Building - 000**

UI PN: CP20XXXX

UNIVERSITY OF IDAHO

Moscow, Idaho



**University of Idaho**

Architectural and  
Engineering Services

**Bid Opening Location:**

Facilities Maintenance & Operations

875 Perimeter Drive MS2281

Moscow, Idaho 83844-2281

**Bid Opening Date/Time:**

Thursday, (Insert Date / Time)

2:00 p.m.

**BIDDER'S NAME AND ADDRESS:**

\_\_\_\_\_  
\_\_\_\_\_  
\_\_\_\_\_

**CONTACT PERSON:** (insert name of UI PM), UI AES, (208) 885-5495

TO: Facilities Architectural & Engineering Services, University of Idaho, Moscow, Idaho

The bidder, in compliance with the Advertisement for Bids for the above-referenced project, having examined the specifications, related documents, and the site of the proposed work, and having become familiar with local conditions surrounding the proposed work, including availability of materials and labor, hereby proposes to perform all work in accordance with the contract documents, within the time limits set therein, and at the prices stated below, which are to cover all expenses incurred in performing the work.

The bidder agrees to complete work on this project per the following schedule:

Pre-Bid Meeting:	(Insert Pre-Bid date and time)
<i>Location:</i>	<i>(insert Pre-Bid location)</i>
Bids Received:	2:00 pm (local time), March 13, 2018
DBS Plan Review Process:	Complete
Issue Notice-to-Proceed to Contractor by:	(Insert anticipated NTP date)
Submittals / Shop Drawing Phase:	(Insert anticipated date range)
On-Site Mobilization:	(Insert anticipated mobilization date)

Construction Period:

?? Calendar Days after On-Site Mobilization  
(Construction Completion by ???)

The bidder agrees to pay as liquidated damages Five-Hundred and No/100 Dollars (\$500.00) per calendar day of delay thereafter.

Bidder acknowledges receipt of addendum(s) number(s) \_\_\_\_\_.  
(Please list)

**BASE PROPOSAL.** Bidder agrees to perform all of the base proposal work described in the specifications and shown on the plans for the sum of

\_\_\_\_\_ Dollars \$\_\_\_\_\_  
(Amount shall be shown in both words and figures. If there is a discrepancy, the amount shown in words shall govern.)

**(NO BID ALTERNATES)**

The bidder understands that the Owner reserves the right to reject any or all bids and to waive any informalities in the bidding.

The bidder agrees that this bid shall remain valid and may not be withdrawn for a period of thirty (30) calendar days after the scheduled closing time for receiving bids.

**SUPPLEMENTARY CONDITIONS:**

1. Following the bid, the University will review the budget, determine the successful bidder and issue a Notice-to-Proceed (N.T.P.) to that contractor.
2. No **Bid Bond** will be required.
3. **Contractor's Affidavit Concerning Alcohol and Drug-Free Workplace.** The bidder shall submit, with the bid proposal, an affidavit certifying his compliance with Idaho Code, Title 72, Chapter 17, requiring the contractor and his subcontractors at the time of bid to provide a drug-free workplace program and to maintain such program throughout the duration of the contract. (See affidavit form included in bid materials.)
4. **Contract.** The successful contractor shall enter into agreement with the University via a standard Facilities Letter Contract. The contractor shall sign and return the letter contract to the University. In addition, at that time, **the Contractor must provide proof of Idaho Workman's Compensation coverage, Idaho Unemployment Insurance and a copy of the contractor's Certificate of Insurance showing general business liability insurance in the amount of \$100,000, valid in the State of Idaho.** The University will then return an executed copy of the contract to the contractor.
5. **Payment and Performance Bond** shall be secured in the amount of 50% of the contract. The surety of the bond shall be licensed in the State of Idaho.
6. The contractor shall be responsible for obtaining and paying for the building permit and all mechanical and electrical permits from Division of Building Safety. The cost of the permits shall be included in the Base Bid. Information and building permit fee tables can be found at the following:  
<https://dbs.idaho.gov/programs/publicworks/>

7. It is anticipated that there will be pay requests submitted monthly on this project. Monthly progress payments will be made based on completed work in the field as reviewed by the UI Project Manager.
8. 5% retainage will be withheld from each monthly pay application. The contractor may submit a final pay application at the end of the project requesting retainage once all punchlist items are completed, close-out documentation is submitted, and keys and other items are returned to the Owner.

**IDAHO NAMING LAW**

Pursuant to Section 67-2310, Idaho Code, the Idaho Naming Law requires that a general contractor must list the business name and Public Works license number of certain subcontractors in the Bid Form at the time the bid is submitted. The law stipulates that these will be the major mechanical and electrical subcontractors who the general contractor agrees to engage to do the work. **The firms listed below must be those who will actually do the work on site, regardless of contractual considerations between the general contractor and the subcontractors.** If the scope of work does not include mechanical or electrical components, any firm hired to do incidental piping or wiring such as the installation of a temporary service to a job trailer, need not be listed.

The names and address of subcontractors to whom work will be awarded, subject to approval of the Owner and architect, if the undersigned is awarded the contract, are as follows:

Does this project involve plumbing? No \_\_\_\_\_ Yes \_\_\_\_\_

Name of plumbing contractor \_\_\_\_\_

Public Works license number \_\_\_\_\_

Does this project involve hydronic piping? No \_\_\_\_\_ Yes \_\_\_\_\_

Name of hydronic contractor \_\_\_\_\_

Public Works license number \_\_\_\_\_

Does this project involve warm air heating, air conditioning or sheet metal work?

No \_\_\_\_\_ Yes \_\_\_\_\_

Name of heating/cooling contractor \_\_\_\_\_

Public Works license number \_\_\_\_\_

Does this project involve electrical work? No \_\_\_\_\_ Yes \_\_\_\_\_

Name of electrical contractor \_\_\_\_\_

Public Works license number \_\_\_\_\_

The State of Idaho policy prohibits purchase of asbestos products and asbestos containing materials for use in or on any facilities, including personal and real property, where acceptable alternatives are available.

The contractor certifies by submission of this bid proposal that the products or materials to be furnished as a result of this bid are asbestos free. Projects for which an adequate substitute is not available shall be identified by a separate written statement. The asbestos content shall be given if known and a certification that no known asbestos substitute exists.

The owner will hold the contractor and/or his supplier(s) liable for any asbestos removal and replacement costs as a result of the contractor's failure to comply with this requirement.

The undersigned notifies that he is of this date duly licensed as a Public Works Contractor and further that he possesses Idaho State Public Works Contractor's License No. \_\_\_\_\_, and is domiciled in the State of \_\_\_\_\_.

Dated at \_\_\_\_\_ this \_\_\_\_\_ day of \_\_\_\_\_, 2020.  
(City, State)

Respectfully submitted,

\_\_\_\_\_  
Name of Bidder (Company)

\_\_\_\_\_  
(Seal, if bid is by a corporation)

\_\_\_\_\_  
Business Address

\_\_\_\_\_  
Signature of authorized representative

\_\_\_\_\_  
Title

\_\_\_\_\_  
Telephone Number

**END OF BID PROPOSAL**

**(SAMPLE)**  
**UNIVERSITY OF IDAHO**  
**REQUEST for CERTIFICATE of INSURANCE**  
**Page 1 of 2**

**Give this form to your insurance agent / broker**

The organization or individual (“Insured”) seeking to negotiate an Agreement or use facilities with the University of Idaho (“Certificate Holder”) is required to carry the types and limits of insurance shown in this Request, and to provide Certificate Holder with a Certificate of Insurance.

- Certificate Holder shall read:

State of Idaho and the Regents of the University of Idaho  
Attn: Risk Management  
875 Perimeter Drive, MS 2433  
Moscow, ID 83844-2433

- Description area of certificate shall refer to the appropriate Agreement, or Facility Use Agreement, or operations of the Insured.
- All certificates shall provide for thirty (30) days’ written notice to Certificate Holder prior to cancellation or material change of any insurance referred to in the certificate.
- All insurers shall have a Best’s rating of A- or better and be licensed and admitted in Idaho.
- All policies required shall be written as primary policies and not contributing to nor in excess of any coverage Certificate Holder may choose to maintain.
- All policies (except Workers Compensation and Professional Liability) shall name the following as Additional Insured: The Regents of the University of Idaho, a public corporation, state educational institution, and a body politic and corporate organized and existing under the Constitution and laws of the state of Idaho.

If Insured is responsible for subcontractors, ISO form CG 2038 0413 shall be used.

- Failure of Certificate Holder to demand a certificate or other evidence of full compliance with these insurance requirements or failure of Certificate Holder to identify a deficiency from evidence that is provided shall not be construed as a waiver of Insured’s obligation to maintain such insurance.
- Failure to maintain the required insurance may result in termination of this grant or contract at the Certificate Holder’s option.
- By requiring this insurance, Certificate Holder does not represent that coverage and limits will necessarily be adequate to protect Insured, and such coverage and limits shall not be deemed as a limitation on Insured’s liability under the terms of the grant or contract.

**(SAMPLE)**  
**UNIVERSITY OF IDAHO**  
**REQUEST for CERTIFICATE of INSURANCE**  
**Page 2 of 2**

*Required Insurance Coverage.* Insured shall obtain insurance of the types and in the amounts described below.

- Commercial General and Umbrella Liability Insurance. Insured shall maintain commercial general liability (CGL) and, if necessary, commercial umbrella insurance with a limit of not less than \$1,000,000 each occurrence and in the aggregate. If such CGL insurance contains a general aggregate limit, it shall apply separately by location and shall not be less than \$1,000,000. CGL insurance shall be written on standard ISO occurrence form (or a substitute form providing equivalent coverage) and shall cover liability arising from premises, operations, independent contractors, products-completed operations, personal injury and advertising injury, and liability assumed under an insured contract including the tort liability of another assumed in a business contract. Coverage for camp participants shall be included. Waiver of subrogation language shall be included. If necessary to provide the required limits, the Commercial General Liability policy's limits may be layered with a Commercial Umbrella or Excess Liability policy.
- Commercial Auto Insurance. Insured shall maintain a Commercial Automobile Policy with a Combined Single Limit of not less than \$1,000,000; Underinsured and Uninsured Motorists limit of not less than \$1,000,000; Comprehensive; Collision; and a Medical Payments limit of not less than \$5,000. Coverage shall include Non-Owned and Hired Car coverage. Waiver of subrogation language shall be included.
- Business Personal Property and/or Personal Property. Insured shall purchase insurance to cover Insured's personal property. In no event shall Certificate Holder be liable for any damage to or loss of personal property sustained by Insured, whether or not insured, even if such loss is caused by the negligence of Certificate Holder, its employees, officers or agents.
- Workers' Compensation. Insured shall maintain all statutorily required Workers Compensation coverages. Coverage shall include Employer's Liability, at minimum limits of \$100,000 / \$500,000 / \$100,000.
- Professional Liability. Insured shall maintain Professional Liability (Errors & Omissions) insurance on a claims made basis, covering claims made during the policy period and reported within three years of the date of occurrence. Limits of liability shall be not less than one million dollars (\$1,000,000).

*If you have additional questions, please contact:*

Risk Management,  
University of Idaho.  
PH (208) 885-6177  
[risk@uidaho.edu](mailto:risk@uidaho.edu)



# **(SAMPLE) PRE-BID CONFERENCE AGENDA**

(Insert Date)

## **Project Name**

### **Building**

for the

UNIVERSITY OF IDAHO

Moscow, Idaho

UI CP# (insert UI Project No.)

## **Attendance:**

- 
- Persons Present:
- (Refer to attached attendance sheet.)

## **Project Team Introductions**

### Design Professional

Name / Title

Phone: 000-000-0000

E-mail: email address

### University of Idaho Project Manger

Name / Title

Phone: 000-000-0000

E-mail: email address

### University of Idaho Construction Inspector

Name / Title

Phone: 000-000-0000

E-mail: email address

## **Description Of The Project:** (Refer to Specification Section 01100 - Summary of Work.)

*(Outline project scope and requirements.)*

## **Bid Opening / Bid Proposal:**

Bid Opening is on \_\_\_\_\_ at 2:00pm at Architectural and Engineering Services, 875 Perimeter Drive, Moscow, Idaho 83844. Bring bids to the Facilities front desk prior to 2:00 where they will be time stamped by the attendant.

This project requires a State of Idaho Public Works contractor's license prior to submitting the bid. A 5% Bid Bond is required to be submitted with each Bid.

Bidders shall take care to fill out the Bid Proposal correctly using verified business names and license numbers.

Make sure to list all Alternates and receipt of addendums.

Make sure to include all required paperwork with the bid. (Bid bond, Power of Attorney, Contractor's Affidavit Concerning Alcohol and Drug-Free Workplace.)

Each Bid submitted must be good for 30 days after the Bid Opening.

100% Performance and Labor and Materials Payment Bonds are required for this project.

There is **no** federal funding on this project and there are **no** prevailing wage requirements.

**Construction Contract / Duration:**

The Construction Contract time period will be \_\_\_\_\_ calendar days from issuance of the Notice To Proceed. If bids are favorable, the Owner intends to issue the N.T.P as soon as possible.

Contract to be standard AIA contracts with University of Idaho standard modifications as outlined in the Specifications.

Liquidated Damages will be assessed at \$\_\_\_\_\_ per day for not completing work within the 75-day contract period as outlined in the Bidding and Contract Requirements.

The estimated construction cost is \$\_\_\_\_\_ as published in the Ad for Bid.

**Bid Addenda:**

An Addendum will be issues by (insert date) and will include the meeting minutes and the attendance sheet from this Pre-Bid Conference.

**Permits and Inspections:**

The State of Idaho Division of Building Safety requires Building Permits for all University of Idaho (and State of Idaho) projects. The contractor shall include the cost of the permit in the bid, as well as obtain the permit at the necessary time. The fee schedule for building permits can be found at the DBS website.

The Owner / Design Professional has already processed and paid for the plan review with the Division of Building Safety for this project. The drawings are approved and ready for permit application. The Plan Review ID# will be issued to the successful bidder.

The Owner will hire a qualified special testing agency for all required construction testing on the project. (Soils, concrete testing, welds, etc ...)

**Base Bid & Alternates:**

*(Outline Base Bid Scope and any additional Bid Alternates or Unit Pricing.)*

**Project Schedule:**

*(Outline overall schedule and any special requirements.)*

**Construction Laydown and Staging Area:**

*(Design Professional and UI Construction Manage or Project Manager to outline preliminary constraints and requirements for project lay-down and staging area.)*

The construction site and the adjacent staging/storage area must be enclosed by a chain link fence. For smaller projects, or where special conditions exist, this requirement may be waived or modified by written agreement

from the UI Project Manager.

**Parking:**

Parking availability is at a premium, and parking enforcement is a critical issue on campus. Violators, including contractors, will be ticketed. Unpaid tickets will be charged to the Contractor.

Construction equipment may be parked within the site confines without a permit.

Construction Permits will be issued to the General Superintendent and the Superintendent for each major subcontractor for their shop pickups. These vehicles must be parked within the site confines or in designated spaces nearby. Construction Permits are issued free by Facilities.

**Questions and/or Discussion:**

*(Document all other questions and discussions raised at the meeting.)*

**Post Meeting Site Walk-Thru:**

*(Document any additional questions and discussions raised at the project site walk-thru.)*

Reported By:

Design Profession Name, Title

cc: Placeholder's List  
project file

**END OF PRE-BID CONFERENCE AGENDA**

# (Sample) Pre-Construction Conference Agenda

*(The design Professional shall incorporate the following information, as applicable, into their own outline or office standard meeting agenda format.)*

DATE: \_\_\_\_\_

PROJECT: \_\_\_\_\_

UI PROJECT NO.: \_\_\_\_\_

CONTRACTOR:  
\_\_\_\_\_

ARCHITECT/ENGINEER: \_\_\_\_\_

## INTRODUCTION OF THOSE PRESENT

Distribution of the attendance sheet

### **Project team**

Project Architect (A/E)

Phone \_\_\_\_\_ cell \_\_\_\_\_ e-mail \_\_\_\_\_  
\_\_\_\_\_

Project Manager (UI)

Phone \_\_\_\_\_ cell \_\_\_\_\_ e-mail \_\_\_\_\_

Construction Manager (UI)

Phone \_\_\_\_\_ cell \_\_\_\_\_ e-mail \_\_\_\_\_

Construction Inspector (UI)

Phone \_\_\_\_\_ cell \_\_\_\_\_ e-mail \_\_\_\_\_

Project Manager (Contractor)

Phone \_\_\_\_\_ cell \_\_\_\_\_ e-mail \_\_\_\_\_

Superintendent (Contractor)

Phone \_\_\_\_\_ cell \_\_\_\_\_ e-mail \_\_\_\_\_

## CONTRACT ITEMS

Distribution of the contract package.

### **Contract**

The contract amount is \$ \_\_\_\_\_

The contract includes Bid Alternates: \_\_\_\_\_

### **Notice to Proceed**

The NTP sets the start and completion dates for the contract.

The start date is: \_\_\_\_\_ .

The contract period is: \_\_\_\_\_ calendar days.

The completion date is therefore: \_\_\_\_\_ .

### **Liquidated Damages**

The contract provides for liquidated damages at the rate of \$ \_\_\_\_\_ per calendar day.

### **Bonds**

If not provided on the Bond and/or Power of Attorney, the name and phone number of a specific person handling inquiries on the Contractor's bonds is required.

### **Subcontractors**

The Contractor is required to submit a complete list of subcontractors and suppliers for review by the A/E and the Owner. A copy of the Idaho State Tax Commission Public Works Contract Report is attached to the contract for this purpose.

An updated list is required as additional subcontractors are engaged by the Contractor.

All subcontractors must hold an Idaho Public Works Contractor's License in the proper categories and in sufficient capacity for their work on the project.

### **Interpretations of the Contract Documents**

The A/E is responsible for all interpretations of the project plans and specifications. These interpretations are to be completed in writing on the proper forms

## **GOVERNING AUTHORITY**

### **Permits and Licenses**

The University has received a plan review approval number from the Idaho Division of Building Safety (DBS). *Verify*. The Contractor is responsible for obtaining and paying for the DBS building permit.

State of Idaho Plumbing and Electrical permits must be secured from DBS by the appropriate subcontractors. Inspections of the plumbing and electrical work must be scheduled through DBS.

CITY OF MOSCOW - The City of Moscow has no permitting or inspection authority on campus. However, the campus branch sewer lines connect to City sanitary and storm sewer mains, and the City is the governing authority for that work. There is no permit or tapping fee required.

Except for those streets which have been vacated as walkways, all streets on campus are City streets.

The City has the responsibility for traffic enforcement, and the City is the governing authority for street ordinances. All cutting and patching, backfill and compaction, traffic re-alignment, use of barricades and flag-persons on City streets must conform to City regulations. The Contractor must obtain the necessary City permits for traffic modifications or street closures. There is no fee.

U.S. ENVIRONMENTAL PROTECTION AGENCY (EPA) - An EPA NPDES permit must be obtained by the contractor prior to the start of work on any project with a total site, including staging areas, 1 acre or larger. This is commonly known as a Storm Water Pollution and Prevention Plan (SWPPP), and it must document how the site will be configured to preclude any storm water from eroding beyond the site limits.

An EPA Notification of Demolition and Renovation permit must be obtained by the Contractor two weeks prior to the start of any work involving hazardous material abatement or selective demolition. There must be a separate permit for each structure. Application for this permit must be coordinated through the University of Idaho Environmental Health and Safety Office (EH&S).

The Contractor will obtain and pay for all other applicable permits, licenses, fees or other charges.

The Contractor must call for utility locations prior to any excavation.

## **PAYMENTS**

### **Schedule of Values**

The Contractor is required to submit a breakdown of contract values, as they will appear on the Pay Request, for review by the A/E and the Owner. Submit 15 days before the first Pay Request.

The Schedule of Values must include a line item for Project Closeout.

The Schedule of Values must include a line item for Commissioning if the commissioning process is an element of the project documents.

### **Payment Requests**

Payment Requests must be submitted on the standard UI form, unless an alternate is approved in advance. The Schedule of Values must be completed and attached. Do not round off. Carry all figures to two decimal places.

Payment Requests should be submitted to the A/E three working days before the date of the monthly construction meeting. Progress should be estimated to include the work that will logically be complete through the end of the 30-day billing cycle.

The UI has 30 days after the A/E's approval of the Pay Request to make payment.

The Contractor shall not withhold from a subcontractor or supplier more than the percentage withheld on a payment certificate for his portion of the work. Idaho code requires that the Contractor must pay subcontractors and suppliers upon receipt of payment from the Owner.

### **Retainage**

5% of the value of the work will be withheld as retainage.

Retainage is withheld, according to Idaho code, to pay subcontractors, suppliers and labor. It can be released upon receipt of the Closing Documents which include the Release of Liens and the Certificate of Payment of Debts and Claims. Retainage is not withheld to guarantee completion of the work by the Contractor. Therefore, to ensure 100% payment on completed items, the Contractor should include a line item in the Schedule of Values for close-out, clean-up and demobilization.

### **Off-site Storage**

Payment for materials stored off site will not be allowed. The UI PM may allow payment for off-site storage in certain special case, but this will require prior approval and inspections from UI representatives.

## **POST-BID REQUIREMENTS**

### **Materials Substitutions**

Materials Substitutions are generally not permitted during the construction phase. Guidelines for the approval of substitutions can be found in the project specifications.

No substituted material will be permitted without an approved Substitution Request.

### **Construction Schedule**

The Contractor is required to prepare and submit a schedule of construction activities, as they are intended to be completed, for review by the A/E and the Owner. For projects over 1 million dollars, the Contractor is to submit a Critical Path Method (CPM) schedule within three weeks after award of the contract.

The Contractor is expected to continuously update the schedule as work progresses and present it at every monthly meeting. Updates shall consist of showing actual work accomplished against the progress expected, as shown on the approved schedule. No adjustment shall be made to the original timeline except for those adjustments authorized by an approved Change Order or Proposal Request.

### **Shop Drawings and Other Submittals**

The Contractor should review the project specifications for submittal format and/or any special requirements such as a submittal schedule or log. The following conditions will apply:

- The Contractor should submit shop drawings and other submittals to the A/E as quickly as practical.
- The Contractor is required to review and approve all submittals prior to submitting to the A/E.
- The Contractor should make every effort to submit relevant drawings and/or other submittals as a complete package.
- Allow two weeks, excluding mail time, for the return of approved submittals.
- The Contractor should retain the appropriate number of submittals for use in the M&O Manuals. Photo-copies of an approved original are acceptable. Three copies of the M&O Manuals are required.
- The owner requires one copy of all submittals for review, concurrent with the submittal to the A/E. The owner does not require Shop Drawings unless requested.
- The total number of copies required is: \_\_\_\_\_ (To be determined at the Pre-construction meeting).

### **Color Selections**

The Contractor should review the project documents to identify all materials and equipment requiring color selections and/or samples.

Final color selections are the responsibility of the UI Project Manager. Selections will be made upon the

receipt of all required submittals.

### **Testing Requirements**

The UI will arrange and pay for all required soils, concrete, welding and/or other required testing.

The Contractor must notify the A/E and/or the UI CM adequately in advance of the work requiring testing (minimum 48 hours). An alternate method by which the Contractor schedules directly with the testing agency may be approved by A/E and Owner.

A/E will determine the frequency and types of testing to be performed.

Testing required in the Electrical and Mechanical specification sections are the responsibility of the Contractor. These tests must be scheduled with Idaho DBS inspectors or with the UI Construction Inspector as applicable.

The Testing Agency for this project is: \_\_\_\_\_

### **Contractor's Project Superintendent**

The A/E and/or the Owner may require background information related to the qualifications and suitability of the Contractor's selected Superintendent.

### **Project Inspection**

The Contractor must coordinate all permit inspections with the local DBS Building Inspector.

Day to day inspections will be made by the UI CI and the A/E. The Field Rep will assist the Contractor with site logistics and coordination of construction activities. The site inspections by the UI CI, the UI PM and the A/E do not in any way imply final acceptance of the work in place, unless specifically stated as such in writing.

The Contractor should be aware that IDBS inspectors, the State Fire Marshall, and other State officials may make site visits. In addition, representatives from the various Facilities departments and shops may inspect the work in progress. The Contractor may require a check-in procedure, and in certain situations may require that these visitors be accompanied by the Field Representative.

City and County Building officials do not have jurisdiction on UI projects, except in some special cases such as the Health Department jurisdiction over food service operations.

### **Project Safety**

Project safety is solely the responsibility of the Contractor. However, the A/E and/or the UI representatives will report instances of unsafe work practices to the Contractor and, in the case of imminent danger, will immediately stop work until the situation is rectified.

The Contractor is required to hold mandatory weekly safety meetings for all personnel employed on the job-site. The Owner requires a copy of the sign-in sheet or agenda as proof of this meeting.

## **CHANGES TO THE CONTRACT DOCUMENTS**

### **Change Orders**

All changes to the contract must be authorized by a Change Order. All Change Orders must correspond to an A/E issued Proposal Request and/or Construction Change Directive (CCD).

### **Proposal Request**



Change items must be initiated by the A/E issuance of a Proposal Request (PR). If the Proposal Request constitutes a change in scope, the UI Project Manager must approval the PR before it is issued to the Contractor by the A/E.

#### Construction Change Directive

A Construction Change Directive (CCD) may be used as a method of gaining quicker approval for change items. The A/E can issue a CCD for minor changes, and the work in question may proceed. Subsequent pricing of the CCD must be approved by the A/E, and the amount of the CCD will be included in the next Change Order much as a Proposal Request would be.

#### Supplemental Instruction

The A/E may issue a Supplemental Instruction (SI) to make minor, no-cost changes. SI's require the A/E and the Contractor's signature. By signing, the Contractor is indicating his agreement that the changes included are no-cost changes. Failure to sign within 21 days constitutes acceptance of the SI.

In order to facilitate checking of quotations for extras or credits, all proposals, except those so minor that their propriety can be seen by inspection, shall be accompanied by a complete itemization of costs, including labor, materials, equipment and subcontracts. In no case will a change involving over \$1,000 be approved without such itemization.

Contract time extensions or deletions must be requested as a Proposal Request, and must be approved as a component of a Change Order. No adjustment of the contract time and no modification to the project schedule may be made except through this process.

## **RECORD DOCUMENTS**

### **Record Drawings**

The Contractor is required to keep a clean set of contract plans and specifications, marked-up with all changes during the course of construction.

The A/E is required to review the drawings at the monthly construction meeting.

At the project completion, these as-built documents must be submitted to the A/E for review and approval. Submission of these documents is a component of the close-out process.

### **Maintenance and Operations Manuals**

The Contractor is required to prepare and submit manuals containing maintenance, operation, product, technical, warranty and certification information for materials and equipment used in the project. Three copies are required. The Contractor should check the project specifications for specific requirements on content and format.

The M&O Manuals must be submitted to the A/E at the end of the project. Final acceptance requires the approval of the A/E and the UI Project Manager prior to final payment.

## **PROJECT CLOSEOUT**

### **Certificate of Substantial Completion**

- The Contractor should conduct a preliminary inspection to verify the status of his work and that of his subcontractors. The Contractor shall then notify the Architect in writing that the project is complete and ready for final inspection. This notification must also include a list of any items known to be incomplete.
- The A/E will schedule a Substantial Completion inspection as soon thereafter as possible. The Project Manager and other UI representatives will submit a list of concerns to the A/E prior to the inspection, or

they will accompany the A/E on the inspection.

- The issuance of the Certificate of Substantial Completion, signed by the A/E, represents the actual completion date with respect to the contract time period. The Contractor is to sign the Certificate and send it to the UI Project Manager within three days of receipt.
- A list of items requiring completion or correction must be attached to the Certificate. Record Drawings, M&O Manuals, warranties, and other close-out documentation, not submitted at the time of Substantial Completion must be included in the list. Under no conditions will the Contractor be given more than 30-days to complete the list.
- Failure to complete the items on the punch list within the time stated on the Certificate will be considered a violation of the contract.
- The issuance of the Certificate of Substantial Completion starts the warranty periods, except for those items on the punch list. The Owner's insurance coverage begins at this point also.
- Substantial Completion won't be awarded until the DBS inspector can issue the Certificate of Occupancy or Certificate of Completion.

### **Project Closeout Requirements**

- Record Drawings must be submitted and approved.
- M&O Manuals must be submitted and approved.
- All product and equipment warranties must be submitted.
- A statement of the Contractor's one year warranty of materials and workmanship must be submitted.
- UI maintenance and operation training must be completed and signed off.
- The A/E's final acceptance letter/checklist must be submitted to the UI Project Manager.
- The forms, Consent of Surety, Release of Claims, and Affidavit of Payment of Debts and Claims, must be executed and submitted.
- A final Payment Request, requesting 100% payment, may now be made. A separate Payment Request is required for release of retainage.

## **MISCELLANEOUS ITEMS**

### **Meetings**

Monthly project meetings are required. These meetings are to be set up, chaired and recorded by the A/E. Minutes will be sent to all parties concerned no later than 10 days after the monthly meetings. Approval of these minutes will take place at the next meeting. A prepared agenda is to be used.

Pre-installation Conferences are required prior to the start of significant elements of the work on major capital projects. They are encouraged on all projects. The required Pre-installation Conferences will be determined by the PM and/or the consulting A/E. Typical examples could include utilities, CIP concrete, concrete flatwork, steel erection, masonry, mechanical installations, paint and roofing.

Weekly subcontractor coordination meetings are encouraged at the discretion of the Contractor. The UI CI and/or UI CM may attend.

## **Parking**

Parking availability is at a premium, and parking enforcement is a critical issue on campus. Violators, including contractors, will be ticketed. Unpaid tickets will be charged to the Contractor.

Construction equipment may be parked within the site confines without a permit.

Construction Permits will be issued to the General Superintendent and the Superintendent for each major subcontractor for their shop pickups. These vehicles must be parked within the site confines or in designated spaces nearby. Construction Permits are issued free by Facilities.

All other employees may park in the limited free spaces around campus, or they may purchase monthly parking permits from Parking Services.

## **Fences and Barricades**

The construction site and the adjacent staging/storage area must be enclosed by a chain link fence. For smaller projects, or where special conditions exist, this requirement may be waived or modified by written agreement from the UI Project Manager.

All barricades and temporary barriers must be hard, constructed type. Sandwich boards, saw horses, plastic construction fence and tape or ribbons are not acceptable barriers.

All signs and traffic control devices used for street work must conform to DOT requirements. Flag Persons must be employed during any work which encroaches into any drive lane. Flag Persons must wear an orange vest and hard hat.

The movement of all equipment and delivery vehicles through campus, and any construction activity that takes place outside the site confines, must be accompanied by a spotter on foot.

## **Temporary Utilities**

The Contractor may make connection to the campus steam distribution system, and may use campus steam for temporary heat if practical. There is no charge for the steam. Connections must be made under the supervision of UI Facilities personnel, and provisions must be made to return the treated condensate to the campus system.

The Contractor may make connection to the campus domestic water system, and may use campus water for construction purposes. There is no charge for the water. Connections must be made under the supervision of UI Facilities personnel, and a reduced pressure (RP) backflow preventer must be used on each connection.

The Contractor may make connection to the campus electrical distribution system, and may use campus power for construction purposes. There is no charge for the electricity. Connections must be made by a licensed and qualified electrician, under the supervision of UI Facilities personnel. Any necessary switches, transformers, panels or other equipment required is the responsibility of the Contractor.

## **Other**

The University cannot dedicate sufficient staging area to accommodate an unlimited number of office or construction trailers on site. The Contractor is responsible for controlling the trailers allowed within the site confines. Some additional space is available for parking trailers at a location remote from the site.

All anticipated utility, building service or fire system shutdowns should be shown on the project schedule if possible. The UI requires minimum 2-week notification of any shutdown.

Any work that may affect fire alarm systems, including bagging of them, must be approved by the UI Environmental Health and Safety Office. This includes, but is not limited to, sweeping of construction

material in the area of detectors.

The Contractor will be responsible for disposing of all construction materials waste. UI dumpsters will not be used unless prior approval has been given by the UI Project Manager in special circumstances.

If any suspected asbestos containing material is encountered and is at risk of being disturbed, the Contractor must contact the UI CI or the UI PM. Do not disturb the material. The UI has an in-house abatement shop that may be able to remove small amounts of material with minimal down-time.

The campus landscape comprises a high profile and high value resource. All effort will be made by the Contractor to prevent damage to any and all landscape items such as lawns, planting beds, trees, shrubs, sidewalks, sprinkler irrigation systems, signage, etc. Any disturbance of the landscape caused by storage, parking, driving, trenching, excavating, etc. must be approved by the UI Project Manager or the owner's representative prior to the work. The Contractor may be required to take extraordinary measures to protect the landscape. These could include such things as fencing to the drip line of any endangered tree, placing plastic or tarps under certain equipment, and excavation of shrubs for re-planting elsewhere by UI personnel.

The construction site is required to be isolated against migration of dust and odors into occupied adjacent buildings. Care must be taken to avoid operating equipment near building air intakes, and the Contractor may be required to construct dust barriers over nearby windows. Watering of the soils or building materials must be accomplished during dusty earthwork or demolition.

Door lock cylinders and keys will be shipped from Schlage Lock Company direct to the U of I, Facilities Locksmith. The Contractor shall provide the UI with the name and address of the hardware supplier for the project as soon as possible. The UI will provide the supplier with a signed authorization form listing the appropriate restricted keyway number to forward to the lock company. Cylinders and keys will be shipped zero-bitted by registered mail only to the UI Facilities Locksmith.

The UI Design and Construction Project Document Standards are on the Facilities web site. The contractor is encouraged to view the web site and raise a question with the Project Manager where substantial elements are not found in the project specifications. Other helpful forms, instructions and documents are also available on this site. Go to [www.uidaho.edu](http://www.uidaho.edu), click Services, then Facilities Management, then Forms and Standards.

## **OTHER DISCUSSION**

### **END OF PRECONSTRUCTION CONFERENCE AGENDA**

**(Sample)**  
**Warranty Deficiency Report No. 1**



**University of Idaho**

Architectural and  
 Engineering Services

**Project Name**  
**Building Name**  
 UI Capital Project No.  
 University of Idaho  
 Moscow, Idaho

Architect:  
**Architect Name**  
 Street Address  
 City, State, Zip  
 Phone Number  
 E-mail

Contractor:  
**Architect Name**  
 Street Address  
 City, State, Zip  
 Phone Number  
 E-mail

<b>Description of Deficiency:</b>	<b>Noted By:</b>	<b>Date:</b>	<b>Emergency or Critical Repair?</b>
Item #1	(Insert who noted deficiency)	(Date deficiency was noticed)	(insert "yes" or "no")
Item #2 (if multiple items)			
Item #3 (if multiple items)			

Submitted By: \_\_\_\_\_ Date: \_\_\_\_\_  
 (signature of UI PM)

***This table to be filled out by General Contractor***

<b>Description of Corrective Action Taken:</b>	<b>Corrected By:</b>	<b>Date:</b>
Item #1	(Insert who corrected deficiency)	(Insert date deficiency corrected)
Item #2		
Item #3		

**Owner Accepts Corrective Work by Contractor:** \_\_\_\_\_ Date: \_\_\_\_\_  
 (signature of UI PM)

**Facilities Maintenance & Operations**

**Key/Access Authorization Form for Contractors**

**Project Manager** \_\_\_\_\_

**Work Order #** \_\_\_\_\_

1. AES Approval \_\_\_\_\_ Date: \_\_\_\_\_

2. **Date keys scheduled to be returned: (Filled out by PM)** \_\_\_\_\_

\*\*\*\*\*

3. Company Name: \_\_\_\_\_ Project \_\_\_\_\_ CP# \_\_\_\_\_

4. Name: \_\_\_\_\_  
Last First Middle

5. Permanent Address and Phone \_\_\_\_\_

6. Driver's License # and Issuing State: \_\_\_\_\_

\*\*\*\*\*

I understand and agree that the key(s)/access listed above have been issued to me for official authorized University of Idaho business use only, are the property of the University of Idaho, and are to be returned to Facilities when the project requiring the keys/access ends or upon request.

I understand and agree that I am responsible for the security of the keys/access, their proper use and the spaces they unlock while under my care.

I agree that I will not lend the keys/access to others or permit any to be reproduced.

I also understand and agree that misuse and or loss of the keys/access issued to me could result in severe disciplinary action up to and including prosecution and/or restitution to re-key all affected areas.

I understand that project retention will not be released until keys and Facilities short term access cards are returned.

7. **Signature of Individual Receiving Key(s)/Access** \_\_\_\_\_ Date: \_\_\_\_\_

\*\*\*\*\*

8. Key Shop Authorization: \_\_\_\_\_ Date: \_\_\_\_\_

9. Keys Picked Up- Witnessed By: \_\_\_\_\_ Date: \_\_\_\_\_

10. Signature and date verifying returned keys \_\_\_\_\_ Date: \_\_\_\_\_

## **Contractor/ Visitor Key Check-out Step by Step Instructions.**

**IMPORTANT:** Keys cannot be checked out to any firm or person that does not have a contract, a letter of contract, or a purchase order specifically with the UI. (NOTE: sub-contractors will no longer be able to check out keys, they must obtain access via the General Contractor or contract holder)

1. The Key request authorization form is filled out lines 1 thru 4 by the project manager or authorized UI agent making the key/access request. Forms are available in the PM file cabinet. Use the back of the form for specific access information or specific room numbers, etc.
  2. The request form is placed in the interiors mail box.
  3. Key shop will process the form, make the keys, and sign line # 9. Completed key requests will be placed in the contractor key p/u basket at the front desk. Allow 24 hours for keys to be processed.
  4. Pick up keys. The contractor fills out lines 5 thru 8. A UI employee signs line #10 and places the form in the corresponding PM file in the file cabinet at the front desk.
  5. Keys returned. Facilities employee receives the keys, inquires which project and project manager then pulls the form from the PM file cabinet. Place the keys with the form in the interiors mail box. **NOTE:** Attach keys to form using an envelope & paper clip – Do not tape keys to the form.
  6. Key shop then processes returned keys and returns form to the specific project manager file. If a full return is made line #11 is signed. PM's check forms prior to authorizing final pay request.
- NOTE:** Partial key returns will be processed but line #11 will not be signed. (Line #11 must be signed prior to final pay requests being processed.)
7. Payment requests for CP's, letter contracts and P.O.'s must be checked against the forms for key requests and the appropriate return signatures. Payments cannot be made unless line #11 is signed by the key shop personnel.