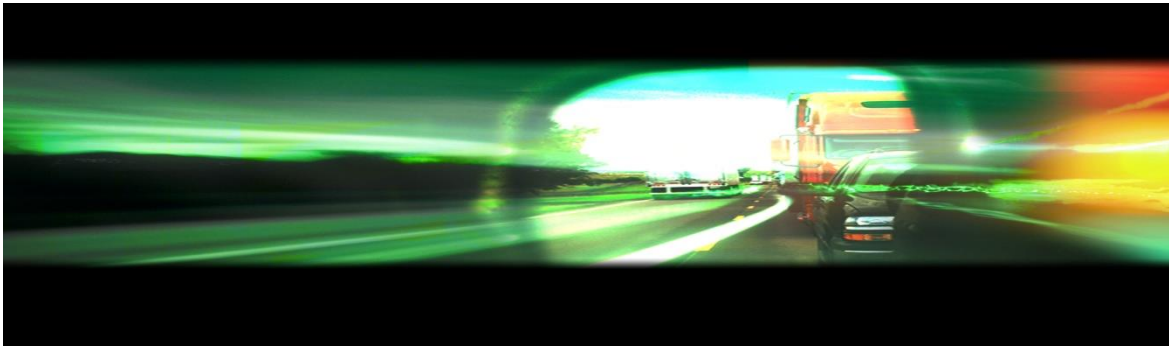


# FORMULA HYBRID SAE

Final Report  
KLK908\_N13-01



# Tran*LIVE*

Dylan Rinker, Dr. Steve Beyerlein,

Dr. Edwin Odom, Dr. Herb Hess

September 2013

## DISCLAIMER

The contents of this report reflect the views of the authors, who are responsible for the facts and the accuracy of the information presented herein. This document is disseminated under the sponsorship of the Department of Transportation, University Transportation Centers Program, in the interest of information exchange. The U.S. Government assumes no liability for the contents or use thereof.

1. Report No.	2. Government Accession No.	3. Recipient's Catalog No.	
4. Title and Subtitle Formula Hybrid SAE		5. Report Date September 2013	
		6. Performing Organization Code KLK908	
7. Author(s) Rinker, Dylan; Beyerlein, Dr. Steven; Odom, Dr. Edwin; Hess, Dr. Herb		8. Performing Organization Report No. N13-01	
9. Performing Organization Name and Address  National Institute for Advanced Transportation Technology University of Idaho PO Box 440901; 115 Engineering Physics Building Moscow, ID 83844-0901		10. Work Unit No. (TRAIS)	
		11. Contract or Grant No. DTRT12GUTC17	
12. Sponsoring Agency Name and Address  US Department of Transportation Research and Special Programs Administration 400 7th Street SW Washington, DC 20509-0001		13. Type of Report and Period Covered Final Report: January 2012 – September 2013	
		14. Sponsoring Agency Code USDOT/RSPA/DIR-1	
15. Supplementary Notes:			
16. Abstract  User-friendly tools are needed for undergraduates to learn about component sizing, powertrain integration, and control strategies for student competitions involving hybrid vehicles. A TK Solver tool was developed at the University of Idaho for this purpose. The model simulates each of the dynamic events in the Formula Hybrid Society of Automotive Engineers (FHSAE) competition, predicting average speed, acceleration, and fuel consumption for different track segments. Model inputs included manufacturer's data along with bench tests of electrical and IC engine components and roll-down data. This vehicle performance model was used to design the 2014 vehicle's hybrid architecture, determine the energy allocation, and to select the batteries. Model predictions have been validated in full vehicle tests under simulated race conditions. The TK Solver tool has proven effective in making decisions about sizing gasoline and electric power components, establishing an optimal coupling connection between the electric motor and the gasoline engine, selecting and configuring the battery pack, tuning the gasoline engine, and making recommendations for energy management under different driving conditions. The resulting vehicle is being readied to compete in the 2014 FHSAE competition.			
17. Key Words  hybrid vehicle design; energy management; vehicle performance testing; parallel hybrid		18. Distribution Statement  Unrestricted; Document is available to the public through the National Technical Information Service; Springfield, VT.	
19. Security Classif. (of this report)  Unclassified	20. Security Classif. (of this page)  Unclassified	21. No. of Pages 63	22. Price ...

**TABLE OF CONTENTS**

FIGURES .....	ii
TABLES .....	iii
EXECUTIVE SUMMARY .....	1
DESCRIPTION OF PROBLEM.....	2
Formula Hybrid SAE .....	2
Formula SAE at the University of Idaho .....	2
Battery System .....	4
Energy Allocation .....	5
Coupling Location .....	6
Performance Model.....	6
APPROACH AND METHODOLOGY .....	7
Model Description .....	7
Track Creation .....	10
Score Predictions .....	12
Model Outputs .....	14
Design Issues .....	17
Performance Model Implementation .....	18
Component Design.....	22
Design Issues .....	25
Performance Model Implementation .....	25
Component Design.....	25
Power Management .....	32
FINDINGS; CONCLUSIONS; RECOMMENDATIONS .....	33
Roll-down Test.....	33
Frontal Area Estimation .....	34
ICE Bench Testing.....	35
Drag Strip Test.....	41
Autocross Test .....	42
Testing and Modeling .....	45
Current Vehicle Suggestions.....	49

Future Vehicle Suggestions .....	51
REFERENCES .....	54
APPENDIX A: Drawings and Specifications .....	55
High Voltage Wiring Diagram.....	56
Output Shaft Drawing .....	57
Electric Motor Specifications .....	58
APPENDIX B: Raw Testing Data .....	59
Steady State ICE Fuel Consumption Data .....	60
ICE-Only Track Testing Data .....	62
Hybrid Track Testing Data .....	63

## FIGURES

Figure 1: Completed 2012 vehicle.....	3
Figure 2: 2014 vehicle at time of testing. ....	4
Figure 3: CALB 40 Ah LiFePo cell.....	5
Figure 4: Electric motor torque curve. ....	10
Figure 5: The 2011 autocross event cone layout. ....	11
Figure 6: User created plot of the 2011 autocross event.....	12
Figure 7: Electric-only acceleration event plots. ....	15
Figure 8: Unlimited acceleration event plot.....	16
Figure 9: Vehicle longitudinal dynamic performance. ....	17
Figure 10: Haiyin 6Ah pouch cell.....	22
Figure 11: Battery stack-up render. ....	23
Figure 12: Battery box solid model. ....	24
Figure 13: Battery box. ....	24
Figure 14: One-way bearing. ....	26
Figure 15: R+W coupler between EM and ICE.....	27
Figure 16: Custom (top) and stock (bottom) output shafts. ....	28
Figure 17: EM mount manufacturing – alignment. ....	29
Figure 18: EM mount manufacturing – tack welding. ....	30
Figure 19: EM mount final fit.....	31

Figure 20: Torque available at wheels vs. vehicle speed.....	32
Figure 21: Roll-down test schematic. ....	33
Figure 22: Roll-down test data.....	34
Figure 23: SolidWorks sketch used to calculate frontal area.....	35
Figure 24: Dynamometer testing setup. ....	36
Figure 25: ICE testing schematic.....	37
Figure 26: Steady state torque and hp vs. rpm.....	38
Figure 27: Automated WOT sweep torque and hp vs. rpm. ....	39
Figure 28: BSFC data point locations. ....	40
Figure 29: Brake specific fuel consumption. ....	41
Figure 30: Test track layout. ....	42
Figure 31: Fuel consumption data.....	47

## **TABLES**

Table 1: Performance Model Inputs .....	8
Table 2: Battery Selection Comparison .....	20
Table 3: Acceleration Times.....	42
Table 4: ICE-Only Autocross Test Data.....	43
Table 5: Hybrid Autocross Test Data .....	44

## **EXECUTIVE SUMMARY**

In order to achieve improved efficiency and performance of the University of Idaho's Formula Hybrid SAE vehicle, a mathematical performance model was created through the thesis work of Samuel Wos in 2012 and Brandon Butsick in 2011 [1,2]. This report outlines the use of the vehicle performance model to specify hybrid architecture, determine energy allocation, and select batteries. Vehicle testing was conducted to verify the inputs and outputs of the model. Tests included roll-down, drag strip, and autocross as well as a frontal area calculation. From the roll-down test, the rolling resistance coefficient was found to be 0.06 and the rotational inertia was found to be 2.25 lb-ft-sec<sup>2</sup>. From the drag strip test, the travel time for the 250 foot track was 6.6 second for ICE-only, 6.4 seconds for electric only, and 5.0 second for hybrid. During the autocross testing, the hybrid system operated at an efficiency of 23.5 mpg. On the same autocross course, the ICE alone operated at an efficiency of 18 mpg. Track times and fuel economy predicted by the performance model agreed with these findings. The frontal area calculation found the effective frontal area of the vehicle to be 8.2 ft<sup>2</sup>. The current model is highly accessible to undergraduate design teams participating in the FHSAE competition. A number of model refinements are suggested to make performance predictions even more accurate.

## **DESCRIPTION OF PROBLEM**

### **Formula Hybrid SAE**

The University of Idaho has been studying hybrid vehicle technology through a collegiate design competition, Formula Hybrid SAE. This program gives the university an organizational structure and test platform for hybrid vehicle development. The Society of Automotive Engineers (SAE) is a non-profit educational and scientific organization dedicated to advancing mobility technology for use in everyday life. Formula Hybrid is one of the design and engineering challenges sponsored by SAE for undergraduate and graduate college and university students. Students must design, build, and compete with an open-wheel, single-seat, hybrid race car. Restrictions are placed on the dimensions of the car's frame as well as the size of engine. This puts the focus on ingenuity and problem-solving. The hybrid competition was created and is managed by the Thayer School of Engineering at Dartmouth. The competition is held at the New Hampshire Motor Speedway and includes dynamic events of acceleration, autocross, and endurance as well as static events of design and a marketing presentation. The judges of the competition are professional engineers and industry leaders, making quality design imperative.

### **Formula SAE at the University of Idaho**

The University of Idaho (UI) has been competing in the Formula SAE competition since 2001, where they earned rookie of the year honors. After finishing 58<sup>th</sup> in 2006, the team decided to make the next car a two-year vehicle. This allowed them to make huge improvements, and they finished 14<sup>th</sup> overall in 2008. Continuing with these advancements, the team took 13<sup>th</sup> in 2009. At the beginning of the 2010 season, UI made the switch to the Formula Hybrid competition. In May 2012, UI took a car to the Formula Hybrid competition for the first time. Figure 1 shows the finished 2012 vehicle.





**Figure 1: Completed 2012 vehicle.**

For the first time, UI finished in the top ten with an 8th place finish overall and a 6th place in the design event. The current vehicle was designed and built over 2012 and 2013. It will compete in the competition in 2014. It is pictured in Figure 2.



**Figure 2: 2014 vehicle at time of testing.**

### **Battery System**

The 2012 hybrid vehicle had many areas which could be improved upon. These areas included the battery pack design, allocation of energy between gasoline and battery, and the method and location of coupling the electric motor (EM) and internal combustion engine (ICE). The 2012 vehicle had two battery packs, each with eight CALB brand 40Ah lithium iron phosphate (LiFePo) cells, for a total of 16 batteries. Each battery box weighed approximately 45 pounds. The nominal voltage of a LiFePo cell was 3.2V, multiplied by 16 cells in the system; the total pack voltage was 52V. The CALB cell is shown in Figure 3.



**Figure 3: CALB 40 Ah LiFePo cell.**

The electric motor, a Lynch D135RAGS, has a rated voltage of 110V. The goal of selecting a different battery system was to increase the voltage in order to utilize the full potential of the EM. Additionally, since a different battery was to be selected, decreasing the weight of the system by selecting a lighter option was a large priority.

### **Energy Allocation**

In the 2012 competition each vehicle was allowed to carry only 19.2 MJ of energy during the endurance race. This meant that a decision was necessary to allocate a portion of the energy to gasoline, and a portion of the energy to batteries. For the 2012 vehicle, the decision was an arbitrary one; 70 percent gasoline and 30 percent electric was chosen. Analysis would be required to discover what allocation would actually earn the most points. This meant

simulating various system configurations to explore which one would perform best in the competition.

### **Coupling Location**

The coupling location on the 2012 vehicle of the EM was to the countershaft, pre-transmission, of the ICE. This meant that the EM could use the torque multiplication of the transmission, but it was necessary to shift while using electric only operation, which added detrimental shift time to the electric only acceleration event. The 2012 vehicle also used a pulley system to transfer the torque from the EM to the ICE. This added complexity and weight to the vehicle. The pulley became a target to eliminate in the repackaging of the coupling method.

### **Performance Model**

To address these issues, a performance model was developed through the thesis research of Sam Wos. The vehicle built to compete in the 2014 Formula Hybrid SAE competition was designed based on this performance model. The model was developed at the UI for specific application to a Formula Hybrid SAE racecar. This model provided the information to make initial design decisions for the vehicle's hybrid architecture. Energy allocation, battery selection, EM and ICE coupling location, coupling gear ratio, and fuel tank size were all determined by running various simulations with this mathematical model. The results of all these simulations were recorded and compared to determine the optimum design configuration.

The battery change resulted in a full use of the EM's speed range by increasing the voltage from 52V to 110V. The capacity of the batteries was lowered from 40Ah to 6Ah, which decreased the energy allocated to battery power from 30 percent to 10 percent. The difference in physical battery size, along with using pouch cells rather than form factor cells, decreased the total weight of the high voltage system by approximately 50 pounds.

To decrease time spent on shifting, the coupling location was moved from the countershaft to the output shaft. This required the design and manufacture of a new output shaft that could accommodate torque input from the EM. Moving the coupling location also allowed

changing where the EM was mounted relative to the ICE. The EM was moved to the side of the ICE enabling the armature to be directly coupled to the ICE output shaft, eliminating the 27 pound pulley system that previously transferred the torque on the 2012 vehicle. This change required the design of a unique EM mount that was light, yet held the EM torque and weight. This change also forced a suspension redesign to create space for the EM.

Upon completion, the vehicle underwent testing to validate the model used to design it. These tests included bench testing the ICE system, roll-down testing, as well as full scale testing of the hybrid system under simulated racing conditions. This report details the process of using the performance model to select the hybrid architecture, design the components necessary to implement a hybrid powertrain such as the custom transmission shaft, and the testing done in order to validate the performance model used to create the design.

## **APPROACH AND METHODOLOGY**

### **Model Description**

The model was created in a program called TK Solver. TK Solver is a rule-based equation solver. In addition to declarative rules; functions, tables, and lists can all be defined and used in calculations. Input parameters to the performance model include internal combustion engine (ICE) torque versus rpm information, electric motor (EM) torque versus rpm information, rolling resistance, aerodynamic drag, and system efficiencies. The model uses this information to calculate the acceleration of the vehicle, simulate lap times, and fuel consumption for a race. It also predicts what score the vehicle would earn at the competition. The model approximates the vehicle's behavior using step sizes small enough to consider the state between each step to be in steady-state. Downsides to this type of calculation is that in order to achieve reasonable accuracy, the step sizes are required to be sufficiently small, which increases the time of each calculation as well as truncation error. When run on a desktop computer, this model's calculation time is negligible.

The model is built from the basic considerations of Newton's Second Law to describe both lateral and longitudinal friction limits, powertrain and braking forces. A force analysis reveals all the interactions the vehicle (considered a point mass in this model, future models

can increase accuracy by including weight transfer) has with its environment: traction force, aerodynamic force, rolling resistance, traveling up a grade, and inertial forces of rotating components. Knowing all the forces, as well as the mass of the vehicle, allows for the calculation of acceleration. Combining acceleration with the knowledge of the powertrain behavior characteristics lets the model track velocity, position, and energy consumption. From this information, predictions can be made on the results of a race. Table 1 outlines all the inputs to the model and their values as assumed by Wos during his research. The Findings, Conclusions, and Recommendations section details testing that resulted in updating some of the values and the changes are reported there.

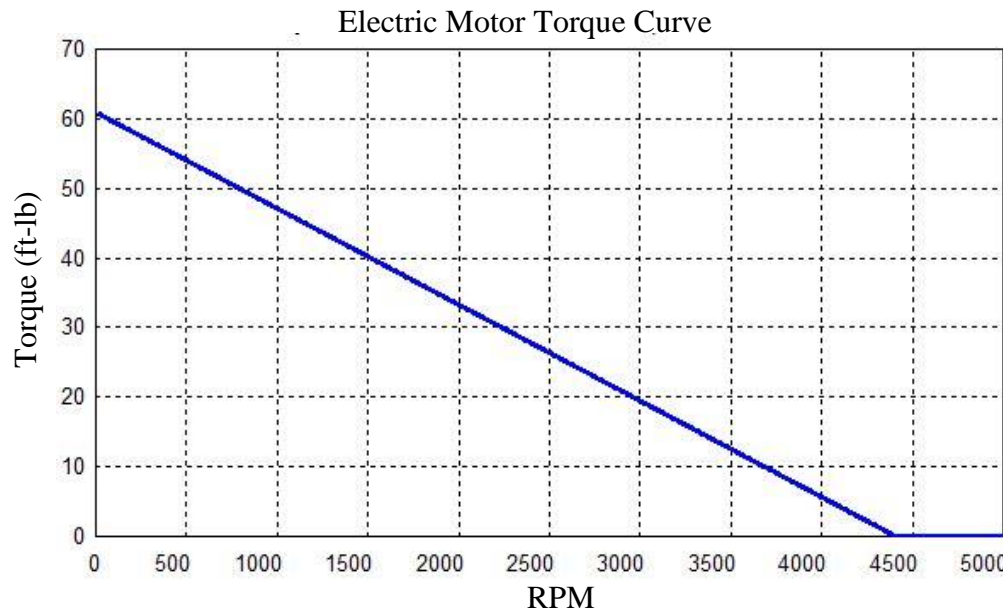
**Table 1: Performance Model Inputs**

Input	Name	Comment
		<b>Vehicle properties &amp; max rpms</b>
675	weight	Current vehicle weight (lbs)
32.2	g	Acceleration due to gravity ft/s <sup>2</sup>
1.70833	tire_diameter	2012 racecar wheel diameter (20.5")
3.3529	primary_r	2005 Yamaha yz250f primary ratio (57/17)
4.5	motor_r	Motor ratio from the motor to the drive wheels
4.5	final_drive	Powertrain final drive from the transmission output to the drive wheels
.81481	top_gear	Transmission top gear (WR250f 5th gear 22/27)
13500	max_crank_rpm	Maximum crank rpm limited by engine
		<b>Vehicle rolling resistance properties</b>
.0433	μ	Vehicle road load from test data (dimensionless)
.07962	ρ	Density of air (lb/ft <sup>3</sup> )
.35	c_d	Vehicle drag coefficient (dimensionless)
9.5	a_cross	Vehicle cross sectional area of car (ft <sup>2</sup> )
0	grade_percent	Track/road grade; unless it's a hill climb set to 0 (length/length in %)
		<b>Maximum accelerations due to tire selection &amp; suspension setup</b>
1.3	g_corner	Maximum cornering in g units (1g=32.2 ft/s <sup>2</sup> ) after weight transfer
1.3	g_accele	Maximum acceleration in g units (1g=32.2 ft/s <sup>2</sup> ) after weight transfer
-1.3	g_brake	Maximum braking in g units (1g=32.2 ft/s <sup>2</sup> ) after weight transfer (- negative for braking)
		<b>Electric drive motor model</b>
110	max_volts	Maximum voltage that the motor was designed for (volts)
110	volts	Maximum available voltage from the accumulator (volts)
7.45	no_load_current	Minimum current to spin the motor (amps)
400	peak_amps	Peak amps available from the accumulator; Note: does not include the no load current (amps)
.85	η	High voltage system efficiency (motor is ~91% efficient; controller is ~95%, etc.)



.21	k_q	Motor torque constant (Nm/A)
40	k_v	Motor speed constant (rpm/v)
4000	motor_rpm	Input motor rpm to verify torque curve (rpm)
		<b>Powertrain shifting parameters</b>
4075	shift_rpm	Shift rpm for combined acceleration (based on countershaft rpm; crank rpm/primary reduction)
.15	shift	Shift delay time (sec)
		<b>Powertrain gearing</b>
2.3846	first	WR250f first gear ratio (31/13)
1.75	second	WR250f second gear ratio (28/16)
1.333	third	WR250f third gear ratio (28/21)
1.04166	fourth	WR250f fourth gear ratio (25/24)
.8148	fifth	WR250f fifth gear ratio (22/27)
		<b>Event times</b>
5.302	t_min_skid	First place skidpad time (sec)
4.576	t_min_e_accele	First place electric only acceleration event time (sec)
4.163	t_min_accele	First place unlimited acceleration event time (sec)
33.209	t_min_auto	First place autocross event lap time (sec)
37.65	t_min_end_lap	First place endurance average lap time (sec)
36	lap_total	Total number of laps to complete 22km
		<b>Fuel &amp; energy consumption</b>
225	bsfc	Engine fuel consumption from test data (g/kw-hr)
2414	fuel_e	Energy density of the fuel being used determined by the competition (wh/liter)

Additional inputs to the model include the ICE and EM torque curves. The ICE torque curve was tested and updated and the results are discussed the Findings, Conclusions, and Recommendations section; the EM torque curve however, is based on manufacturer specifications and is shown in Figure 4. The table of manufacturer’s specifications is given in the appendix.



**Figure 4: Electric motor torque curve.**

### Track Creation

The autocross and endurance events have both straight and cornering sections. A track creation function was required to simulate the driving cycle without physical lap data. The track creation, or plotting, portion of the model requires the user to input the track layout. The track layout must be defined in terms of straights, left-hand turns, right-hand turns, section length, and a corner radius.

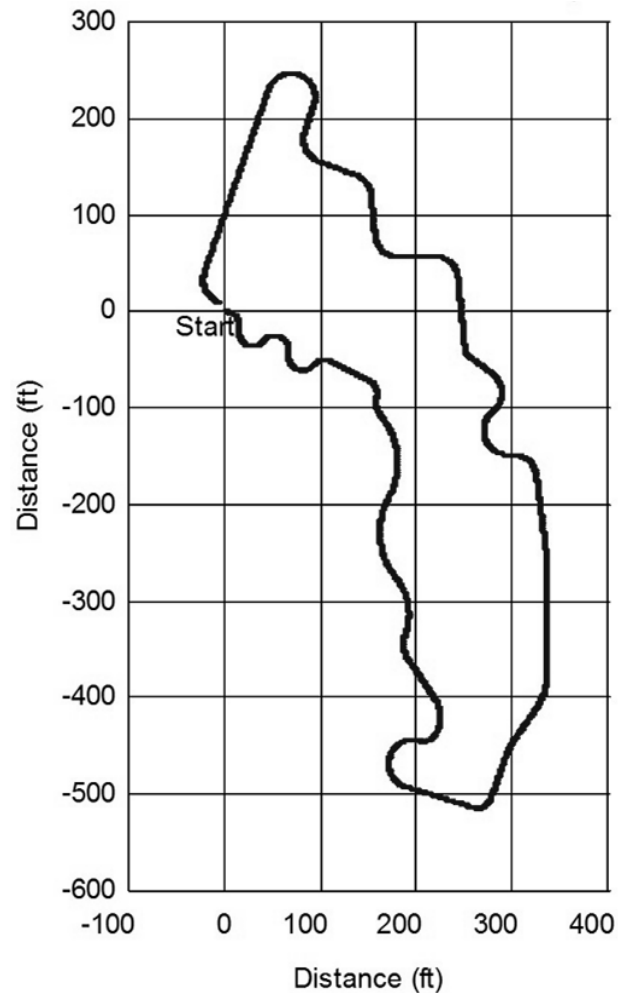
After establishing all the required parameters for the event track, the section plotting function plots the user defined track layout on an X-Y plane allowing the user to visually check the track model. In addition to the visual display, the function calculates total length of the user defined track to provide a numerical check. Pictured below in Figure 5, are the cone locations from the 2011 Formula Hybrid Autocross event.





**Figure 5: The 2011 autocross event cone layout.**

The user must identify straight and cornering sections of the track that will best depict the racing line that the driver would take. The model is not sophisticated enough to discern the correct line for a given track layout, so it is required of the user to identify the ideal path to input for the track plotting and simulation. Once section types have been established, section lengths and radiuses need to be identified to create a track, such as the one pictured in Figure 6.



**Figure 6: User created plot of the 2011 autocross event.**

Figure 6 is the user defined plot of the racing line for the 2011 autocross event. The performance simulation identifies acceleration, cornering, and braking zones to create a drive cycle unique to the track and vehicle. The track plotting model can start with either a corner or a straight section with no limits on length or radius size. [1]

### **Score Predictions**

The performance model predicts the score of each dynamic event. After simulating the velocity and acceleration through a lap, or a straight acceleration event, the final times can be input into the scoring equations. The scoring equations are defined by the rules of the Formula Hybrid Competition. The acceleration event is a 246 foot (75 meter) drag race done

both in electric-only mode and in unlimited (hybrid) mode. The score for both the electric-only and unlimited acceleration events is defined by the following equation:

$$Acceleration\ Score = 60 \times \frac{\left(\frac{0:00:10.0}{T_{your}}\right) - 1}{\left(\frac{0:00:10.0}{T_{min}}\right) - 1} + 15$$

Where  $T_{your}$  is your best elapsed time for a single acceleration run and  $T_{min}$  is the best elapsed time of the fastest team at the competition. As can be seen by analyzing the equation, if your time is 10 seconds or slower, the minimum score for either acceleration event is 15 points.

The  $T_{your}$  is calculated by the model from simulating the lap, while  $T_{min}$  is a user input. To calculate both event scores the  $T_{min}$  used by the model is from the 2011 best times.

The autocross event is a race that demonstrates the vehicle’s maneuverability on a tight course and is scored similar to the acceleration events. The autocross score is defined by the following formula:

$$Autocross\ Score = 120 \times \frac{\left(\frac{T_{max}}{T_{your}}\right) - 1}{\left(\frac{T_{max}}{T_{min}}\right) - 1} + 30$$

Where  $T_{min}$  is the lowest elapsed lap time for the fastest team,  $T_{max}$  is 125% of  $T_{min}$ , and  $T_{your}$  is the lowest elapsed lap time of your team. Similar to the acceleration score, autocross has a minimum of 30 points, even if your time exceeds 125% of the fastest time.

The endurance event is a 22km race with the goal of completing the set distance in the fastest amount of time on a given amount of fuel, 19.2 MJ. The event is scored with the following formula:

$$Endurance\ Score = (P_{max} - P_{min}) \frac{\left(\frac{Max\ Average\ Lap\ Time}{T_{your}}\right) - 1}{\left(\frac{Max\ Average\ Lap\ Time}{T_{min}}\right) - 1} + P_{min}$$

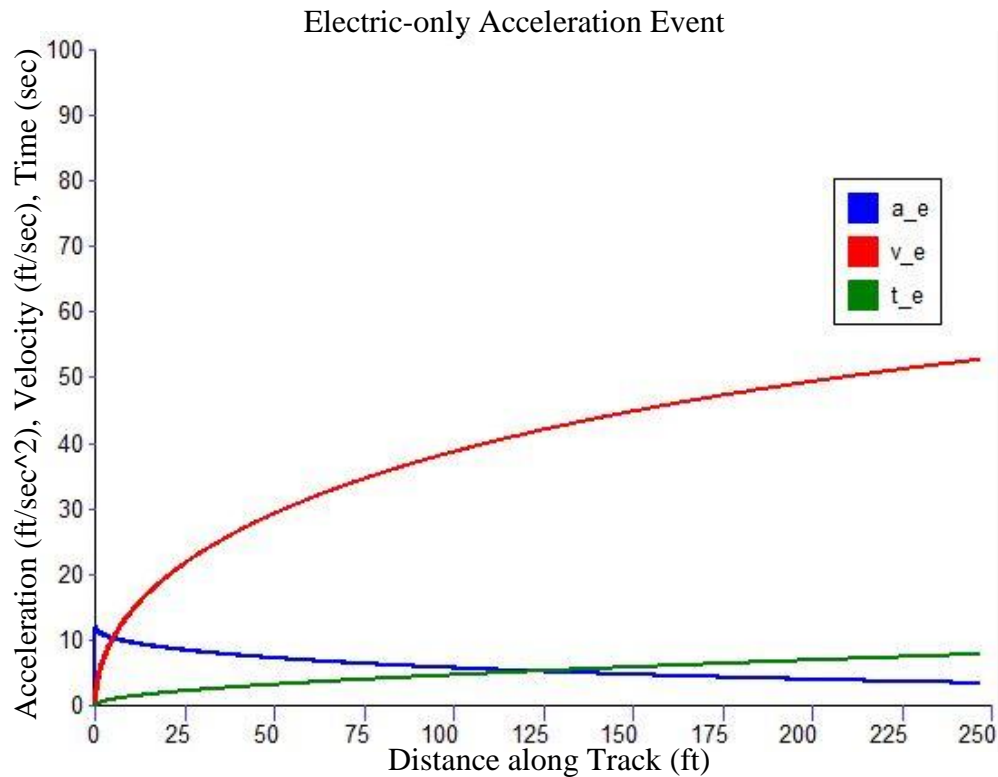
Where the max average lap time is 60 minutes divided by the number of laps to complete 22 km. If a team completes all of the allotted laps, then  $P_{max}$  is 400 and  $P_{min}$  is 80. If a team does not complete the allotted laps, then  $P_{max}$  and  $P_{min}$  are defined by the following equations:

$$P_{max} = 400 * \left( \frac{SumYour}{SumMax} \right) \qquad P_{min} = P_{max} * 0.2$$

Where SumYour is the sum of lap numbers of all laps you completed, for example, if you complete 5 laps  $SumYour = 1+2+3+4+5 = 15$ . SumMax is the sum of lap numbers of all laps to travel 22 km, for example, if 22 laps are required to travel 22 km  $SumYour = 1+2+\dots+21+22 = 253$ .

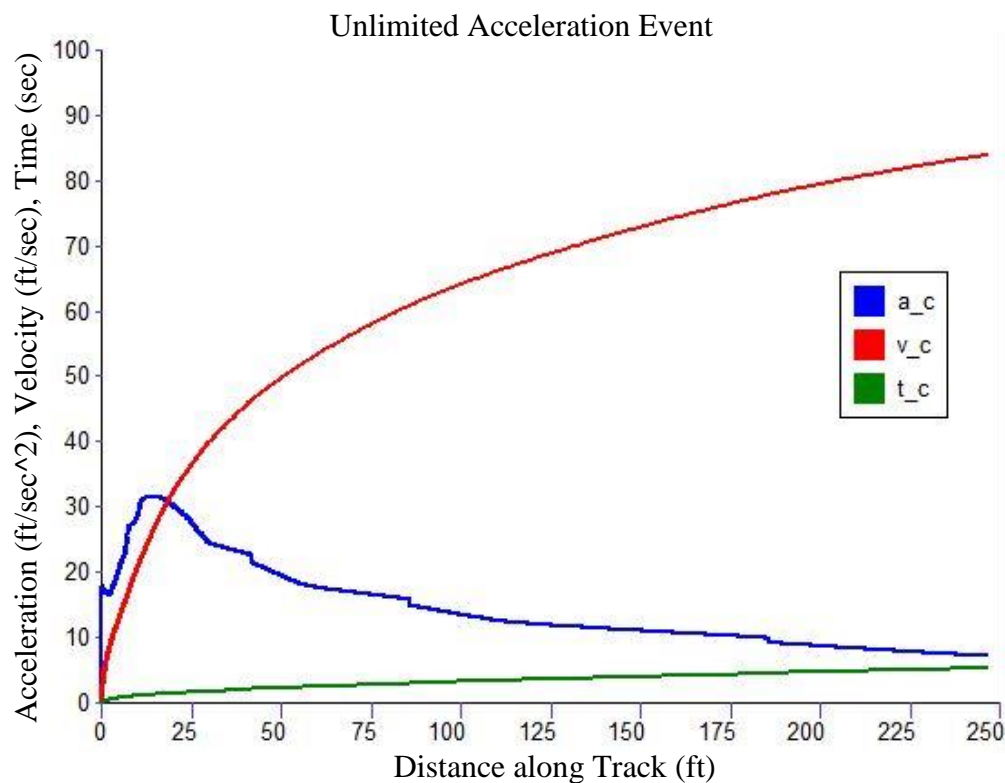
### **Model Outputs**

Configuring the model to the optimum design, it will predict how the 2014 vehicle will perform in the dynamic events at the competition. The first parts of the competition are the acceleration events. The 250 foot electric-only acceleration event is predicted to take 7.7 seconds earning 30 points. Figure 7 shows the acceleration ( $a_e$ ), velocity ( $v_e$ ), and time ( $t_e$ ) versus distance for the electric-only acceleration event.



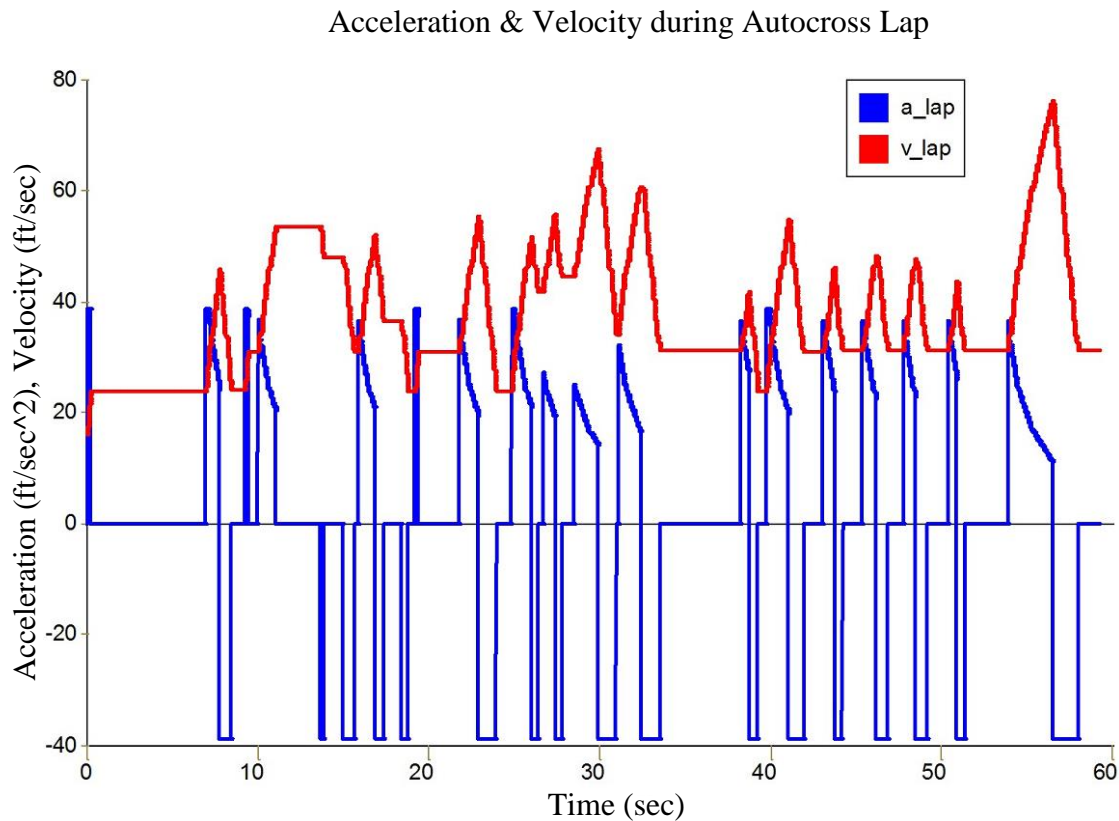
**Figure 7: Electric-only acceleration event plots.**

The unlimited (hybrid) acceleration event is predicted to take 5.2 seconds, earning 55 points. The addition of the ICE to the powertrain creates an obvious jump in the acceleration of the vehicle in the first few feet of the run. Once higher speeds are reached, the acceleration then follows a similar trend as predicted in the electric-only run. It should also be noted that the top speed of the combined run is approximately 87 ft/sec, whereas the top speed reached during the electric-only run is approximately 53 ft/sec. Figure 8 shows the velocity, acceleration, and time of the unlimited acceleration run over the distance of the 246 foot track.



**Figure 8: Unlimited acceleration event plot.**

Based on the 2011 autocross track, the 2014 vehicle would finish one lap in 63.2 seconds. This would earn a predicted 30 points. The shift time during the lap is estimated at taking 0.1 seconds for this lap. Figure 9 shows the output from the model of the simulated lap of an autocross race. The graph shows vehicle acceleration ( $a_{lap}$ ) and vehicle velocity ( $v_{lap}$ ) over the lap. The negative acceleration values are the braking sections. The acceleration values of zero are areas of constant velocity, which only occur during cornering. This is an approximation assuming every corner will be a constant velocity; all braking occurs before the corner and all acceleration occurs after the corner.



**Figure 9: Vehicle longitudinal dynamic performance.**

### Design Issues

The 2012 vehicle used CALB 40Ah cells to create a 6.0 MJ system. The two battery packs each weigh 45 pounds with eight batteries in each pack. The total of 16 cells not only weighed a total of 90 pounds, but occupied a large volume of space. In addition to being heavy and large, the total system voltage was only 52V. The EM's rated voltage is 110V; therefore, the 2012 vehicle was underutilizing the EM by over half its possible potential. These issues were critical to address with designing the 2014 vehicle. The target goals were to increase the voltage to 110V in order to make the best use of the EM as possible, and at the same time select a battery that would be lighter and more compact. To accomplish this, many possible options were analyzed with the UI's TK Solver performance model.

## Performance Model Implementation

The TK Solver performance model was the tool used to determine the battery selection and the energy allocation between gasoline and batteries. The 2014 Formula Hybrid SAE rules allowed for 19.2 MJ of energy to be stored on the vehicle during the endurance event. This includes a 27 percent efficiency consideration for ICE systems and 80 percent efficiency consideration for electric systems [3]. Determining the most advantageous split between gasoline and battery power is a crucial task.

The method of deciding the correct energy allocation was to consider fixed parameters, and then to evaluate what the vehicle score would be based on changing each design parameters. The EM was purchased the previous year by the team, and the budget did not allow for another EM purchase. Thus, the Lynch D135RAGS was a set parameter. The peak current for the EM is 400A, and the rated voltage is 110V [4]. This meant in order to utilize the potentially high torque and speed of this EM, the battery pack needed to be able to provide approximately 400A peak at 110V. The other fixed parameters were the characteristics of each potential battery selection. This included nominal voltage, discharge rate, capacity, weight, and cost. Six potential batteries were considered for this analysis based on their cost, availability, and discharge rate.

For each battery the number of cells required was determined by dividing the rated EM voltage (the desired voltage) by the battery's nominal voltage. In addition, if the required peak amperage of 400A was not reached by a single series string, then batteries would have to be put in parallel to reach the desired capacity. This was calculated by multiplying the cell capacity by the discharge rate (C rate). Having the number of required cells for each potential battery option then allowed a weight, cost, and energy allocation calculation. The weight and cost were simply the number of cells multiplied by each cell's weight and cost. The allocation calculation included the gasoline and electric efficiency considerations. This meant the energy allocated for each set of batteries in Mega-Joules would be calculated as:

$$Energy_{Electric}(MJ) = 0.8 * Voltage_{Nom}(V) * Capacity_{Cell}(Ah) * 0.0036 \frac{MJ}{V * Ah}$$



The remaining energy for gasoline is then calculated as 19.2 MJ minus the electric allocation, divided by an estimated thermal efficiency of 27 percent. At an energy density of 32.2 MJ/L this determined the volume of gasoline allowed to be on the vehicle, and therefore determined the necessary gas tank size. Table 2 shows the comparison of the various battery options.

Table 2: Battery Selection Comparison

Brand	MPG to finish with ICE-only	Gas (L)	% Elec.	Nom. V	C Rate	#	Ah	Battery Pack MJ	Cost per Total Cost	Mass (g)	Total (lbs)	Total Dynamic Score Prediction
<u>Haivin</u>	26	2	10%	3.7	67	30	6	1.9	\$23.00	170	11.1	582.88
<u>PurePower</u>	27.2	1.9	14%	3.6	24	61	8.5	2.7	\$44.00	305	41	579.26
<u>Kokam</u>	29.2	1.8	20%	3.7	20	59	12	3.8	\$60.00	354	46.3	579.52
<u>A123</u>	34.9	1.5	33%	3.3	20	33	20	6.3	\$32.00	480	35.2	580.16
<u>PurePower</u>	46.4	1.1	50%	3.7	5	59	30	9.5	\$59.00	840	109.9	574.64
<u>CALB</u>	68.9	0.8	66%	3.2	10	34	40	12.7	\$48.00	1400	105.9	574.98

The MPG column is the calculated efficiency that the vehicle would need to accomplish in order to finish the endurance event on ICE-only given the allotment of fuel. This is used as a reference to indicate the impact of the tractive system on the vehicle's performance. The Gas column is the amount of gasoline in liters that the particular battery configuration would allocate to gas energy. The % Elec. column indicates the percentage of energy allocated to battery power. Nom V is the nominal voltage of one cell of the particular battery. C rate is the maximum discharge rate indicated by the battery specifications. The # column shows the number of cells to reach both 110V and 400A max discharge. The Ah column shows the capacity of each battery selection. All of this information was input into the performance model and each battery option was simulated. The Total Dynamic Score Prediction column shows the resulting total dynamic scores from the simulations which include the electric-only drag, hybrid drag, autocross, and endurance events predictions.

The Haiyin pouch cells produced the highest scoring configuration with a high discharge rate of 67 C and the lightest cell weight. Additionally, these particular batteries were much less expensive than most of the other options. The design would require 30 cells at a nominal voltage of 3.7V to reach the target 110V pack rating. The only downside to this battery selection is its low capacity at 6Ah. This meant that battery power would run out during the endurance race. Seemingly this would be detrimental, but according to the simulation, it was not. This battery pack would be less than half the weight of any alternative, thus acceleration and autocross times would be better. Running out of battery power during the endurance race did not slow down the vehicle to the extent that a lower endurance score outweighed the gains of the better acceleration and autocross scores. Thus, the Haiyin pouch cells were selected (see Figure 10).

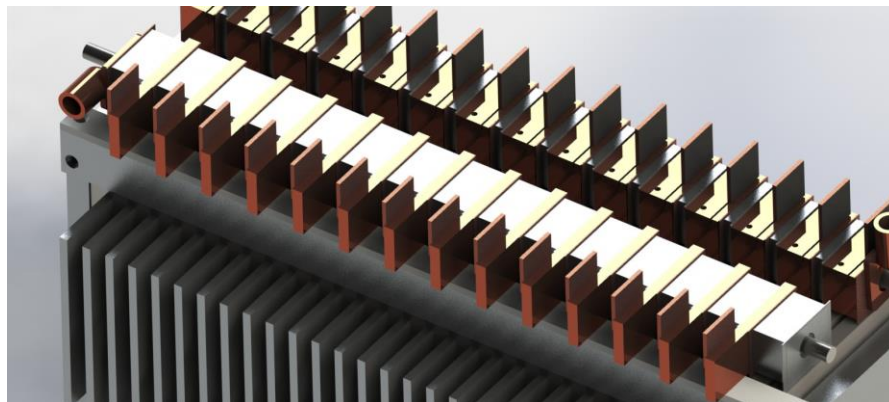


**Figure 10: Haiyin 6Ah pouch cell.**

### **Component Design**

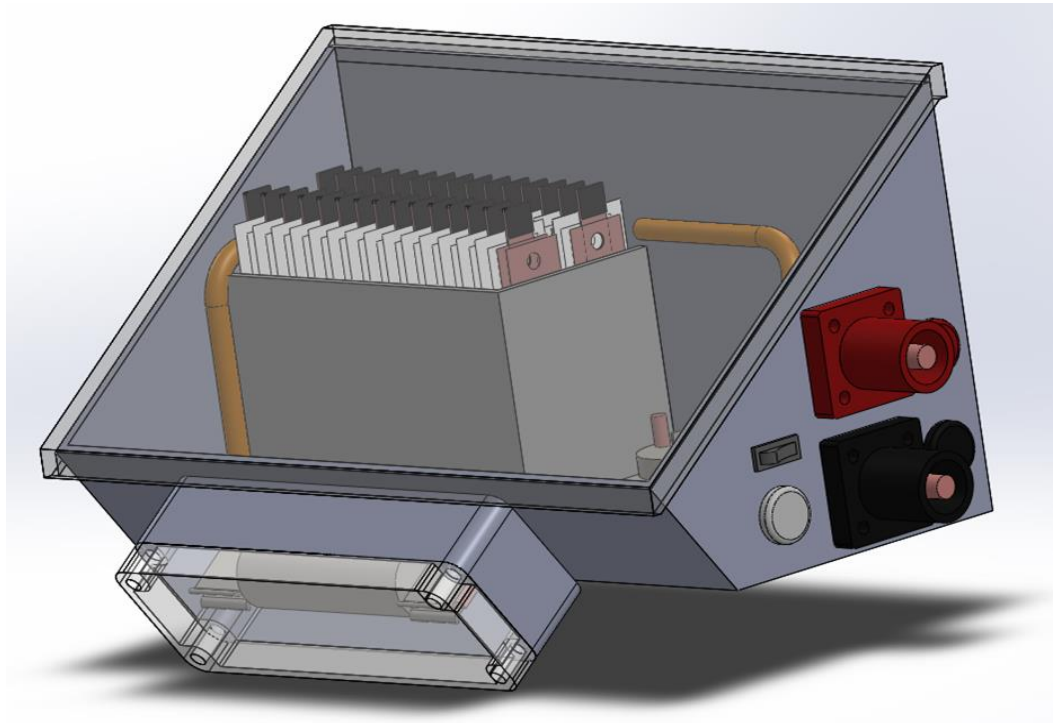
While using the pouch cells saved weight compared to standard form-factor cells, connecting the cells together became an issue. Standard form-factor cells have screw terminals that allow the cells to be connected via copper bus bars or some other bolted connection; the pouch cells however, have tabs that extend from the cell rather than screw terminals. Soldering high voltage battery leads is against the rules, so an alternative connection method was required [3]. To hold the battery tabs together two steel all-thread bolts with insulation sheathing were used. The stack up is made of aluminum and copper blocks between the cell tabs. The copper blocks conduct the electricity, while the aluminum blocks are wrapped in Kapton and glass

fiber tape and provide for correct spacing. The current flows in a zigzag fashion, passing in series through each cell and coming out at each end of the stack up. The ends of the all-thread bolts have 5 Belleville washers and locking nuts to hold the stack-up tight and prevent creep. The data lines and the high voltage lines of the battery management system (BMS) modules are all individually wrapped in an insulating Nomex weave to prevent wires touching. Between the body of each cell, there are 1/8<sup>th</sup> inch aluminum spacers that sticks an inch out the side. The spacers have two functions: to dissipate heat spots and to convect heat away from the cells. Figure 11 shows a render the battery stack-up excluding the battery management wiring and other high voltage circuitry.

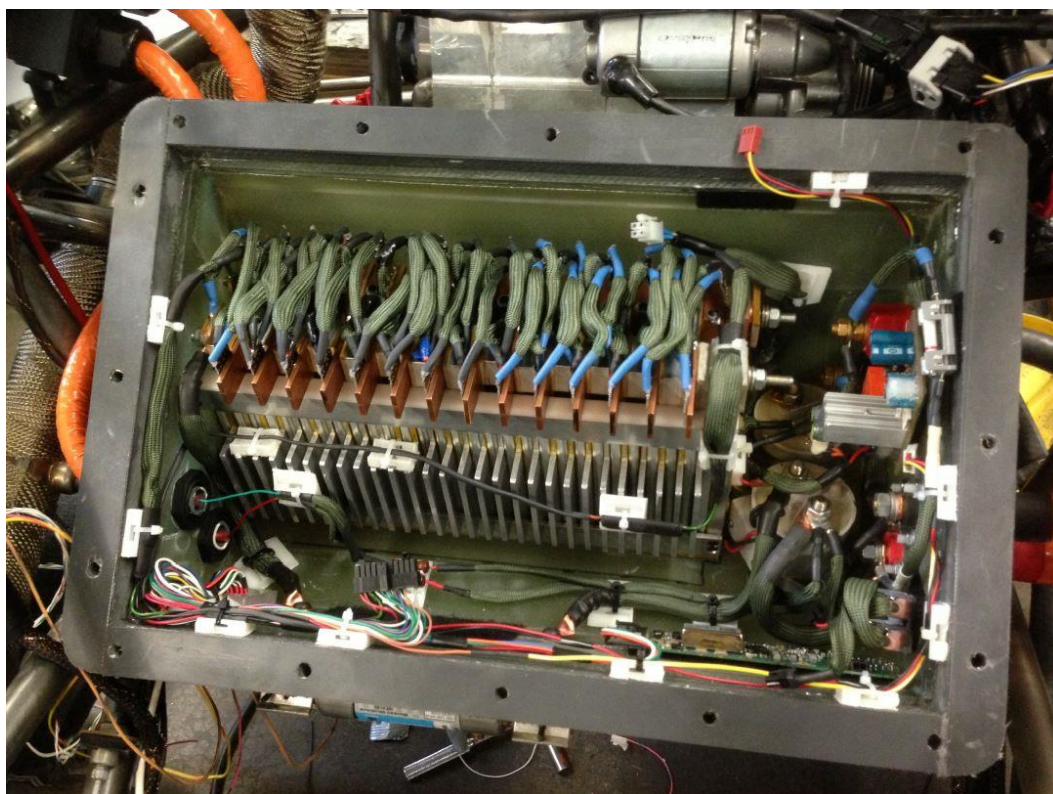


**Figure 11: Battery stack-up render.**

Containment for the battery pack is governed by many rules of the competition [3]. Particular emphasis is put on the strength of the accumulator as well as its electrical insulation. These two requirements fostered an accumulator design that utilized high strength, insulating, and structural fiberglass. Janicki Industries donated time and materials to assist in manufacturing this battery box. The design was created by UI students and then Janicki manufactured the container. Figure 12 shows the solid model of the final product. Figure 13 shows the manufactured box received from Janicki with the batteries and wiring installed. The wiring diagram is located in the appendix. The final accumulator weighs 38 pounds, 52 pounds less than the former design.



**Figure 12: Battery box solid model.**



**Figure 13: Battery box.**

## **Design Issues**

One of the primary design changes between the Formula Hybrid vehicle in 2012 and the vehicle in 2014 is the location of the coupling between the EM and the ICE. Analysis done for the initial 2012 architecture did not take into account shift times experienced by the EM; it only considered the torque multiplication experienced by utilizing a pre-transmission coupling. One of the major discoveries of the model simulation was that the advantages gained from coupling the EM to the ICE pre-transmission did not overcome the losses in shift time. The average shift takes between 0.15 and 0.25 seconds. When coupled to the ICE pre-transmission, the EM would have to shift through the gears from 1<sup>st</sup> to 5<sup>th</sup>. This means four shift events would occur during the acceleration events; up to one second could potentially be added to the acceleration time. An additional second in a race that lasts approximately 6 seconds is a significant detriment. Sufficiently motivated to move the coupling location to a post-transmission configuration, more simulations were ran to determine what ratio between the EM and ICE would be best.

## **Performance Model Implementation**

Based on the performance model calculations, it was determined that a direct one-to-one couple to the output shaft of the ICE was slightly less effective than creating a higher ratio. A ratio of two between the ICE and EM would result in the maximum points possible. The benefit this would provide, however, did not seem to outweigh the inconvenience of packaging an additional gear set or pulley system to increase the ratio between the EM and final drive. Therefore, a direct coupling of the ICE output and EM was selected. Directly coupling the electric motor to the output shaft would require a custom output shaft to be designed, as well as a selection of a coupler that would be able to withstand the torque and impact loading. Additionally, the coupler should be able to forgive slight misalignment of the EM shaft and ICE output shaft.

## **Component Design**

Further concerns of a direct couple system included undesired regenerative action of the EM by the ICE. The potential benefit of this feature was recognized, but the electrical power system has not yet been designed to incorporate a regenerative system, therefore, avoiding



this would be necessary to ensure the safety of electrical components. To avoid a regeneration situation, a one-way bearing was incorporated into the design as seen in Figure 14. The one-way bearing is rated at 66 ft-lbs. This is greater than the maximum torque of the EM (62 ft-lbs.).



**Figure 14: One-way bearing.**

This one-way bearing would allow the EM to introduce torque into the drive system, but prevent the ICE from driving the EM. The one-way bearing also allowed a gasoline-only operation without spinning the EM, which, from an FMEA standpoint, would allow a failure of the electric tractive system, but not stop the vehicle from operating in an ICE-only mode.

To design an output shaft that would stand up to the torque of the electric motor a simple torsion analysis was used. The torsion equation is:

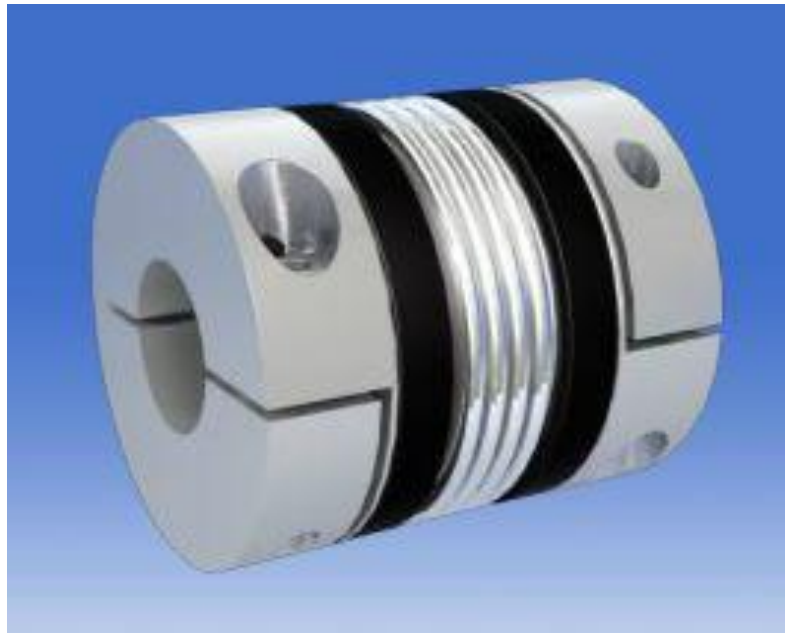
$$\tau = \frac{T * c}{J}$$

Where  $\tau$  is the shear stress, T is the applied torque, c is the radius of the shaft, and J is the polar moment of inertia. The material that was already purchased for previous shafts was an 8620 steel alloy with yield strength of 380 MPa. This meant at a maximum applied torque of 84 N-m, the minimum shaft diameter, if this material were to be used, was 4.8 mm. The design of the stock output shaft used an external nut to hold on a sprocket. The shaft could be



remade with a shank extending out through the stock nut to allow the EM to be directly attached to the shaft. The space available for this shank was 15 mm in diameter, sufficiently large to support the torque based on the calculations. Also, the motor controller has a ramping feature that demands current from the battery pack gradually rather than instantaneously. This ramp (still taking place within fractions of a second) reduces the impact loading on the shaft and coupler by the electric motor adding extra safety to the system. Additional safety for the shaft would be introduced with the coupler itself.

The coupler that was selected fulfilled three primary functions. It allowed for some slight misalignment, safely transmitted the maximum torque, and allowed for the inclusion of a one-way bearing. The R+W coupler, shown in Figure 15, uses a clamping hub with a keyway on the EM side, and on the ICE side has a one-way bearing pressed into it. The one-way bearing then rides on a steel bushing pressed onto the ICE output shaft held on by a keyway and setscrew.



**Figure 15: R+W coupler between EM and ICE.**

The ICE output shaft was reverse engineered from the stock shaft, and then the new shaft was designed with the addition of the shank extension to connect to the EM. The shaft

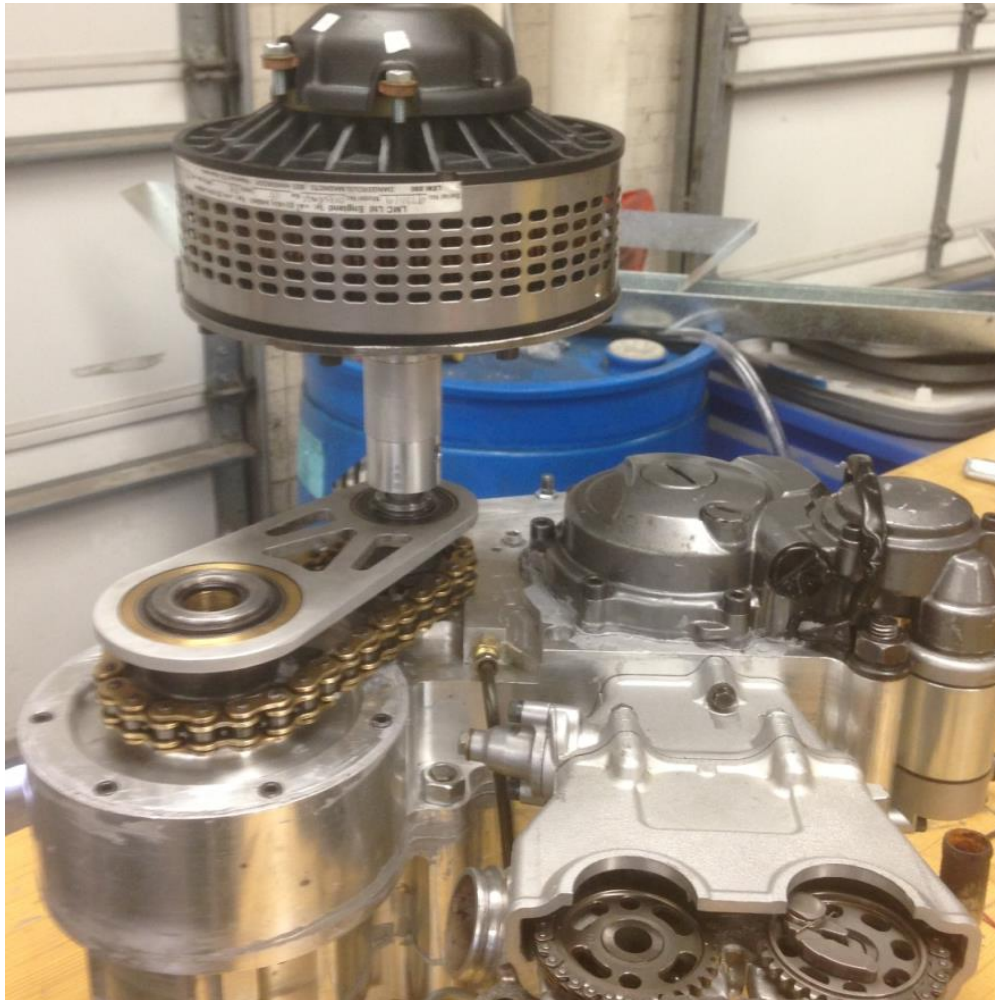
primary shaft dimensions were produced on a Hass CNC lathe at the UI. The splines were also cut into the shaft at the UI using the 4<sup>th</sup> axis on a Hass CNC mill. The final grinding for the bearing surfaces was completed by a professional company. The new shaft is pictured next to the stock shaft in Figure 16 for comparison. Drawings for the custom output shaft are located in the appendix.



**Figure 16: Custom (top) and stock (bottom) output shafts.**

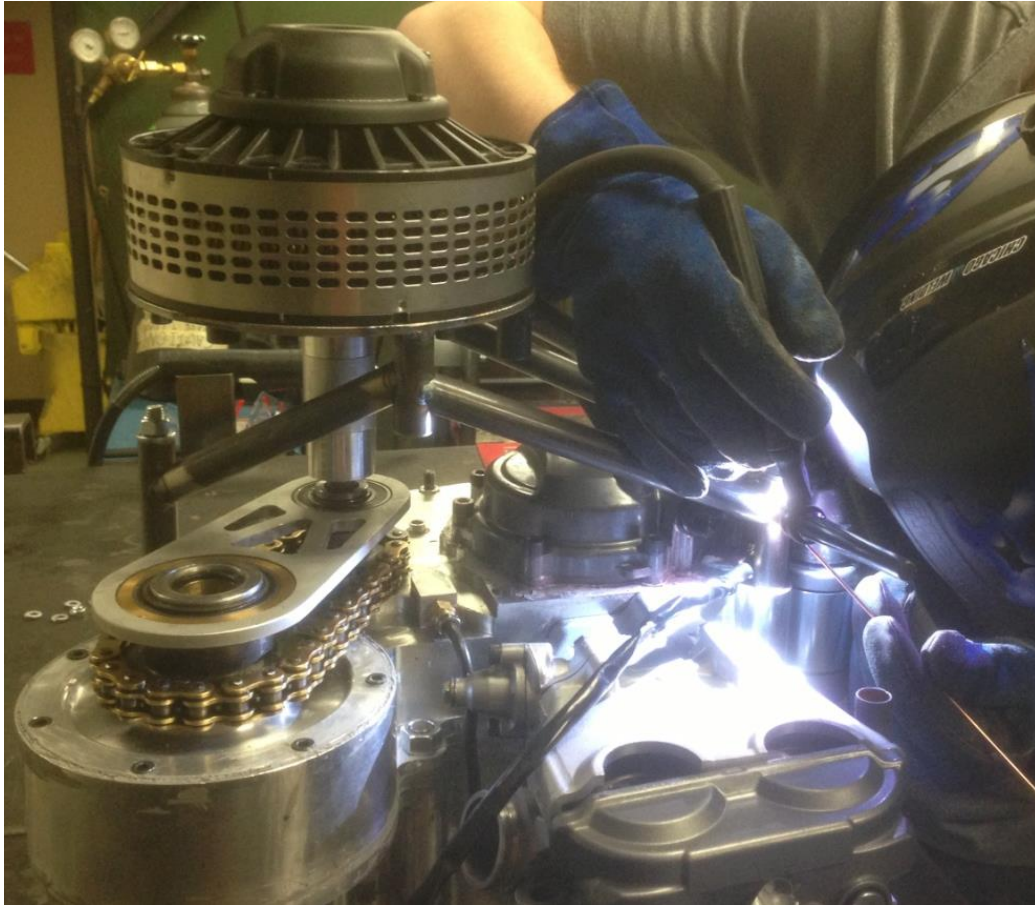
The electric motor mount's primary design objective is to hold the alignment between the electric motor shaft and the ICE output shaft. The R+W coupler allows for small misalignment, but the design and construction attempted to minimize misalignment as much as possible. In order to decrease weight while maximizing stiffness, a tetrahedron-style shape was selected. Analysis of the EM mount was done in CATIA V5 using its FEA simulation. The weight of the EM, as well as the torque it produces, needed to be supported such that deflection of the EM shaft was less than the specified range that the R+W coupler was designed for. Additionally, the EM mount needed to be able to be installed without having to remove the ICE and as few other components as possible. In order to manufacture the EM mount with these desired characteristics, the actual engine was used as the jig to align the pieces. The manufacturing process is shown in the following figures. Figure 17 shows the EM aligned with the output shaft using a temporary aluminum spacer. The aluminum spacer

holds the EM and output shaft in correct alignment as well as the EM the correct distance from the ICE.



**Figure 17: EM mount manufacturing – alignment.**

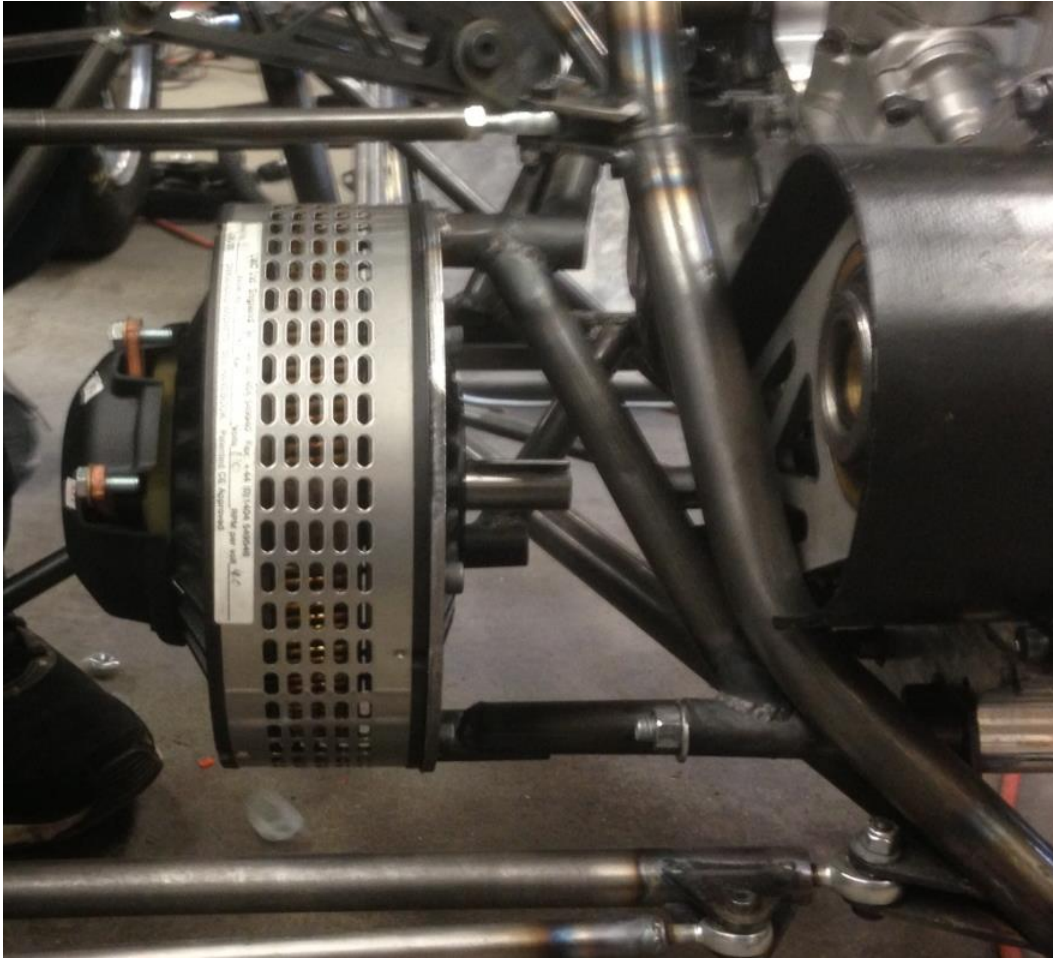
After the EM was aligned with the output shaft the bracing was tack welded together. This was done slowly to ensure heat did not distort the alignment. Test fits were conducted as it was tacked together to ensure that the bracing did not interfere with the chassis. This process is shown in Figure 18.



**Figure 18: EM mount manufacturing – tack welding.**

Figure 19 shows the EM mounted in its final location on the chassis.



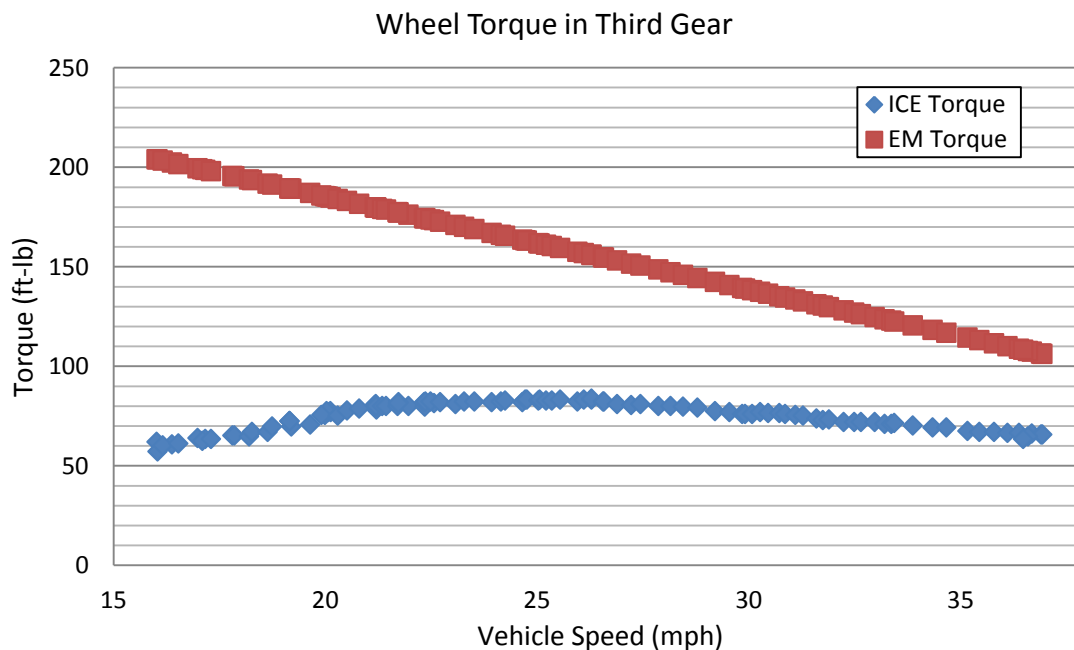


**Figure 19: EM mount final fit.**

The result was a stiff triangulated design that held the EM within the required deflection. Analysis of the EM mount's natural frequency also indicated that at no point in the EM's operation would resonance occur. The EM fits around the frame and ICE such that it can be removed from the vehicle without disassembling any systems or parts. To accomplish this, the triangulation of the EM mount is not a true tetrahedron, but additional supports were added to ensure rigidity.

## Power Management

The method of control for both the ICE and EM is based on throttle position. The required torque is split passively between the two systems, meaning no information about previous operating points or future operating points determines the torque demand. The implication of this system is that the rate at which throttle position demands torque is the only method of adjusting the load between the systems. Presently the motor controller demands a one-to-one percentage available torque from the EM based on the throttle position. For example, if the throttle position is 50 percent then the motor controller is demanding 50 percent of the available torque from the EM based on the throttle position. The speed of the EM is the determining factor of torque available from the EM (see Figure 4). This is illustrated in Figure 20, which shows the torque available at the wheels from each system based on vehicle speed in third gear.

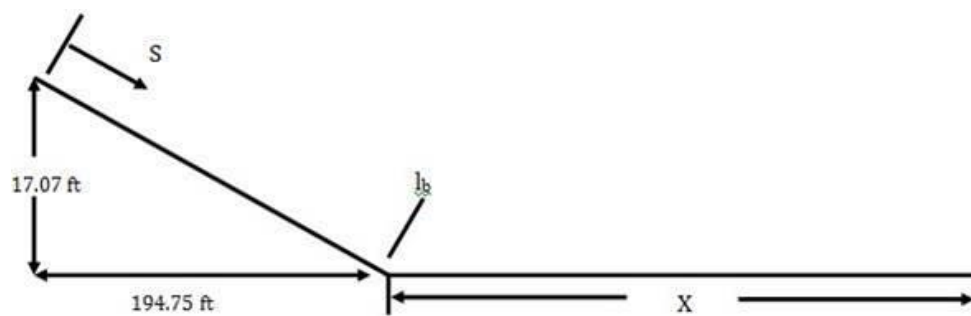


**Figure 20: Torque available at wheels vs. vehicle speed.**

## FINDINGS; CONCLUSIONS; RECOMMENDATIONS

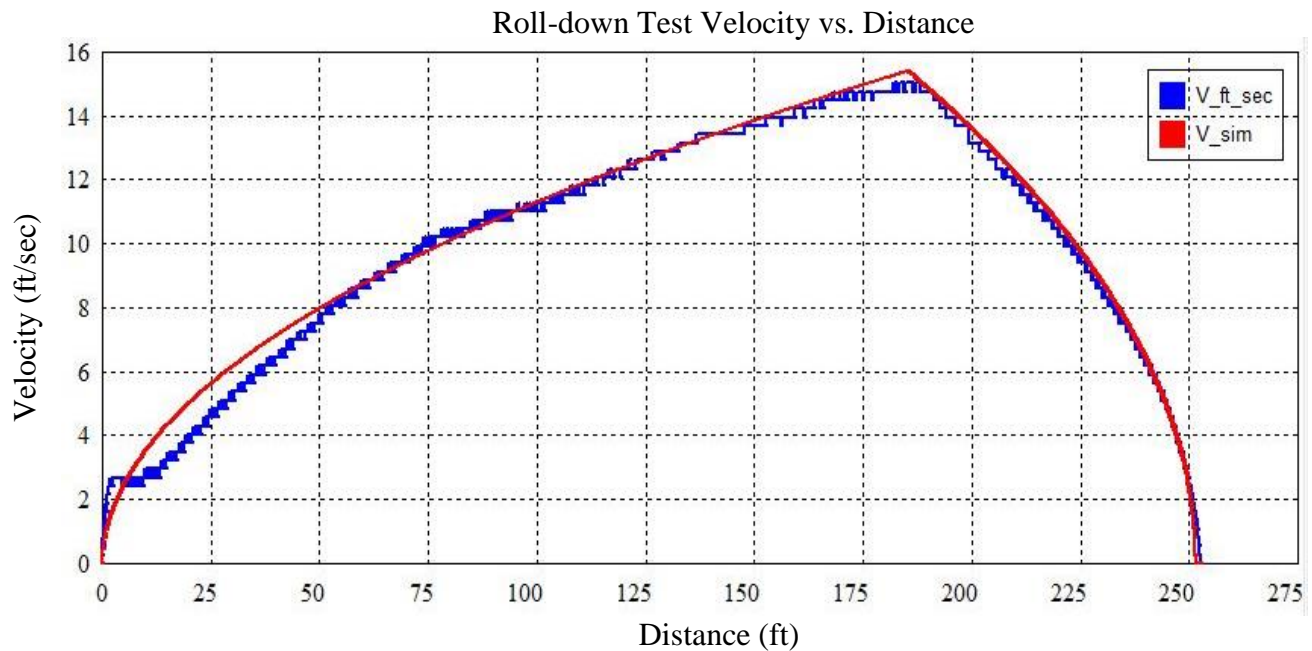
### Roll-down Test

An important input to the vehicle performance model is the rolling resistance. To verify this value, as well as validate improvements of the wheel spindle design, a roll-down test was performed. The test involves letting the vehicle roll down a hill of known height and known angle, then letting the vehicle come to a stop on the flat at the bottom of the hill. This is depicted in the schematic of Figure 21.



**Figure 21: Roll-down test schematic.**

During this roll-down, the distance is measured over time. With the distance-time curve, the calculation of velocity can be done by taking the derivative. With the velocity information, the distance-velocity curve can be constructed. This empirical data from the test was then compared to an analytical distance-velocity curve. Fitting the analytical curve to the data depends on the rolling resistance coefficient. This can be selected such that the root mean squares (RMS) error between the data and analytical curve is minimized, resulting in an accurate estimate of the rolling resistance coefficient value. This analysis was done using the TK Solver program. The inputs to the program include the distance-time information as well as the weight of the vehicle, height of the hill, angle of the hill, and rotational inertia of the vehicle. Figure 22 shows the analytical velocity and measured velocity during the distance down the hill and until coming to rest on the flat. It should be noted that this data includes aerodynamic drag, but at a maximum of approximately 15 ft/sec, it can be considered negligible. After analysis was done it was determined that the rolling resistance coefficient is 0.06 for this vehicle.



**Figure 22: Roll-down test data.**

### Frontal Area Estimation

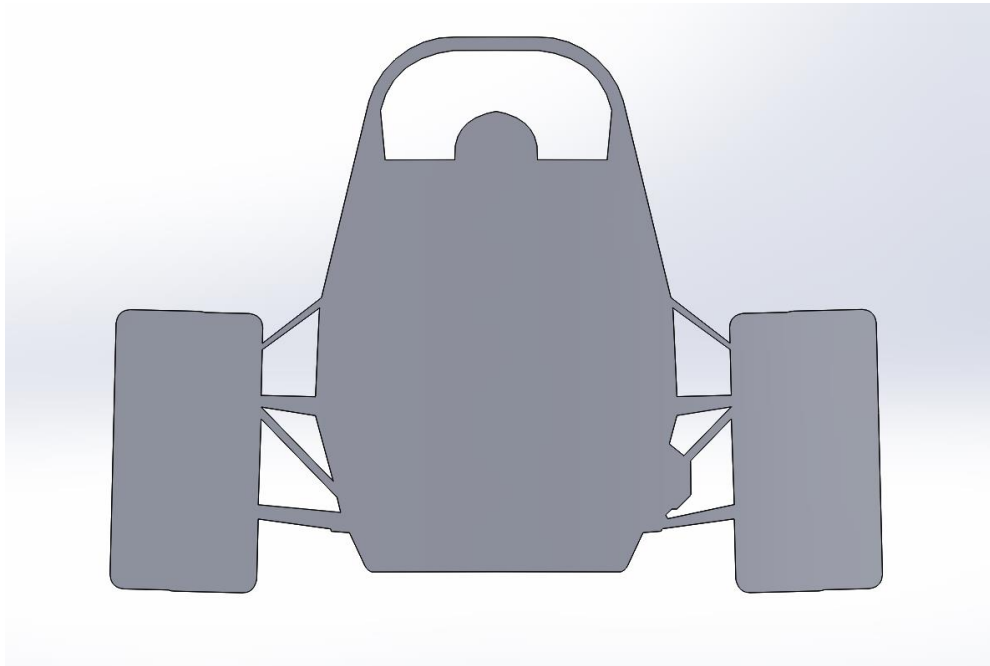
Aerodynamic drag can potentially be a large portion of road load at high speeds. The most accurate way to model this is with wind tunnel testing. Unfortunately, wind tunnel testing was beyond the scope of the current project. Furthermore, the performance model used the standard drag force equation, shown below, to calculate the aerodynamic drag.

$$F_D = C_D * A * \frac{\rho * V^2}{2}$$

The fluid density and velocity terms,  $\rho$  and  $V$ , are independent of the vehicle geometry and can be considered accurate. The coefficient of drag and frontal area,  $C_D$  and  $A$ , however, are very dependent on the vehicle geometry. When the performance model was used to design the 2014 vehicle these values were assumptions. Once the physical vehicle was constructed, the frontal area and the drag coefficient needed to be verified. It was possible to accurately verify the frontal area, but to calculate an accurate coefficient of drag is beyond the scope of the current project. An assumed value of 0.32 is used in the model, a value used by other formula car teams in their analyses.



The frontal area was addressed by using SolidWorks. The area of the solid model was projected onto one plane. Evaluating the section properties revealed that the frontal area is 8.2 ft<sup>2</sup>. The original assumptions used a value of 9.5 ft<sup>2</sup> in the performance model, a significant difference [1]. Figure 23 shows the SolidWorks sketch used to calculate the frontal area.



**Figure 23: SolidWorks sketch used to calculate frontal area.**

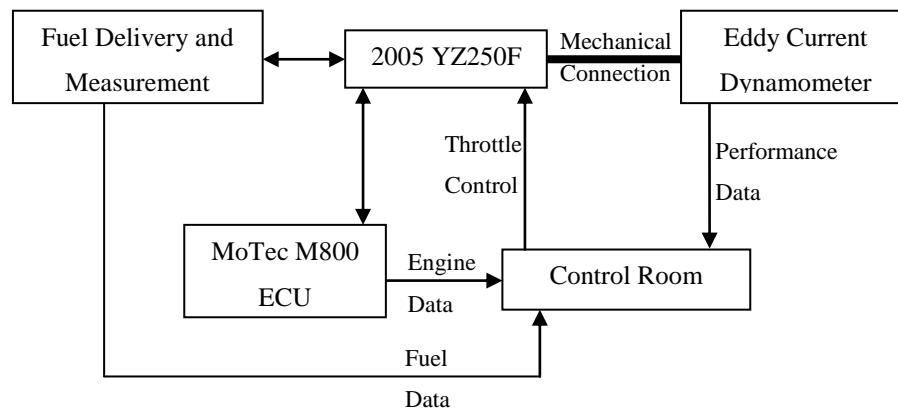
### **ICE Bench Testing**

Testing the YZ250F occurred on an eddy-current dynamometer. This testing used a separate engine from the one to be used on the vehicle. This allowed the construction of two wiring harnesses resulting in the ability to quickly swap the engine control unit (ECU) and ignition module in order to go from engine testing to vehicle operation in a short time. The test engine setup is shown in Figure 24.



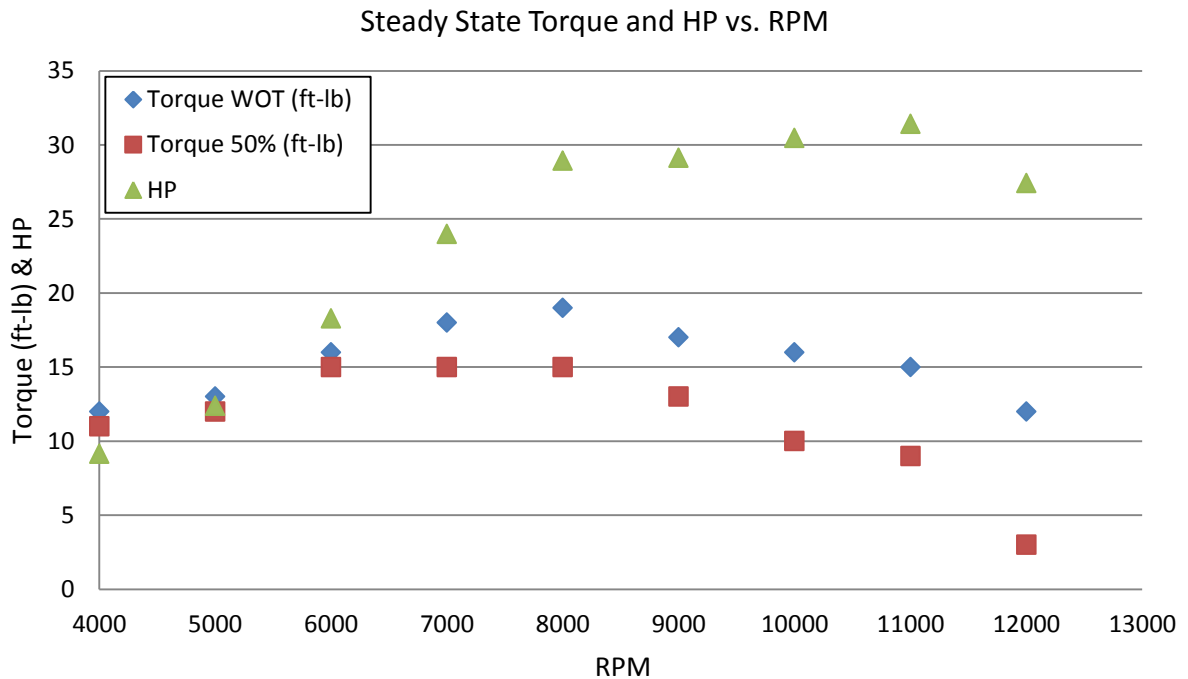
**Figure 24: Dynamometer testing setup.**

The dynamometer is operated by setting a desired engine speed. The dynamometer will start applying torque to hold that desired speed. For example if the desired test speed was 6000 rpm, the dynamometer would not apply resistance until the throttle was opened up enough for the engine to reach that speed. Then once the engine reaches the desired speed, opening the throttle more will only increase the amount of torque required by the dynamometer to hold the desired speed. In this way the torque can be measured at the desired rpm and load. The testing that was conducted on the YZ250F included: steady state measurements of torque at wide-open throttle (WOT), an automated WOT acceleration test, and steady state fuel consumption measurement. Figure 25 shows a schematic of the testing setup.



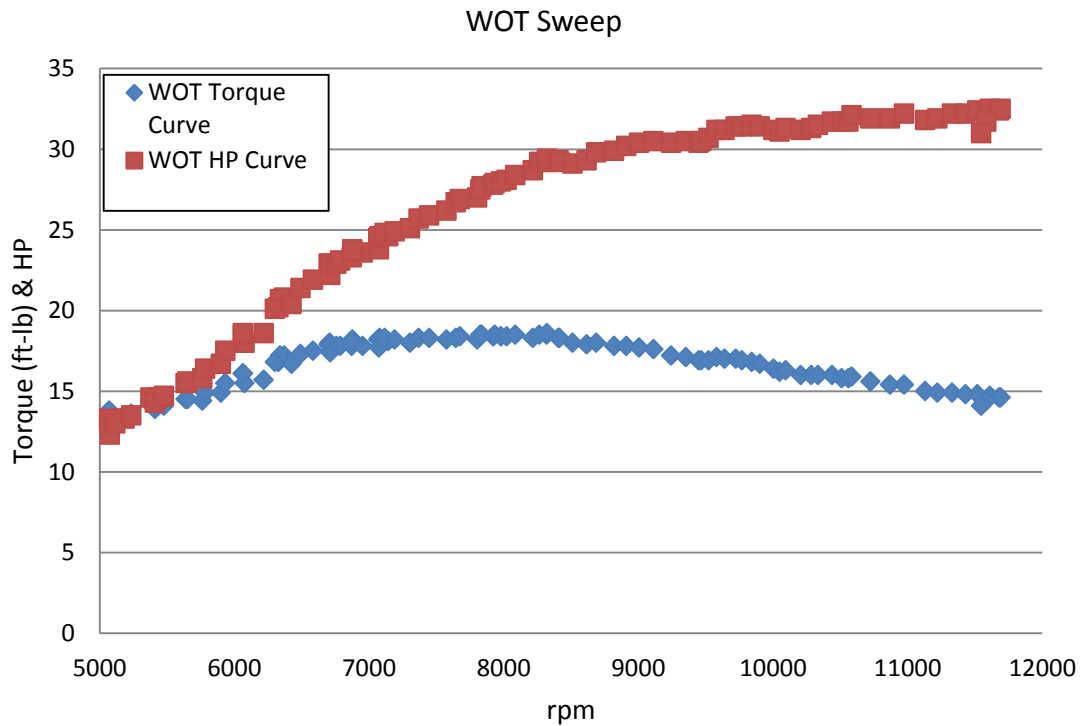
**Figure 25: ICE testing schematic.**

Measurement of the steady state torque at WOT was done every 1000 rpm from 4000 rpm to 12000 rpm. To measure this, the desired speed was set, and then the throttle was increased until WOT. This produced the maximum torque output for that engine speed which was recorded. In addition to WOT, 50 percent throttle measurements were also taken. Due to fluctuations in the measured torque by the dynamometer, the recorded values are best approximations from observation, not time averaged values or maximums observed. Figure 26 shows the steady state torque and horsepower curves.



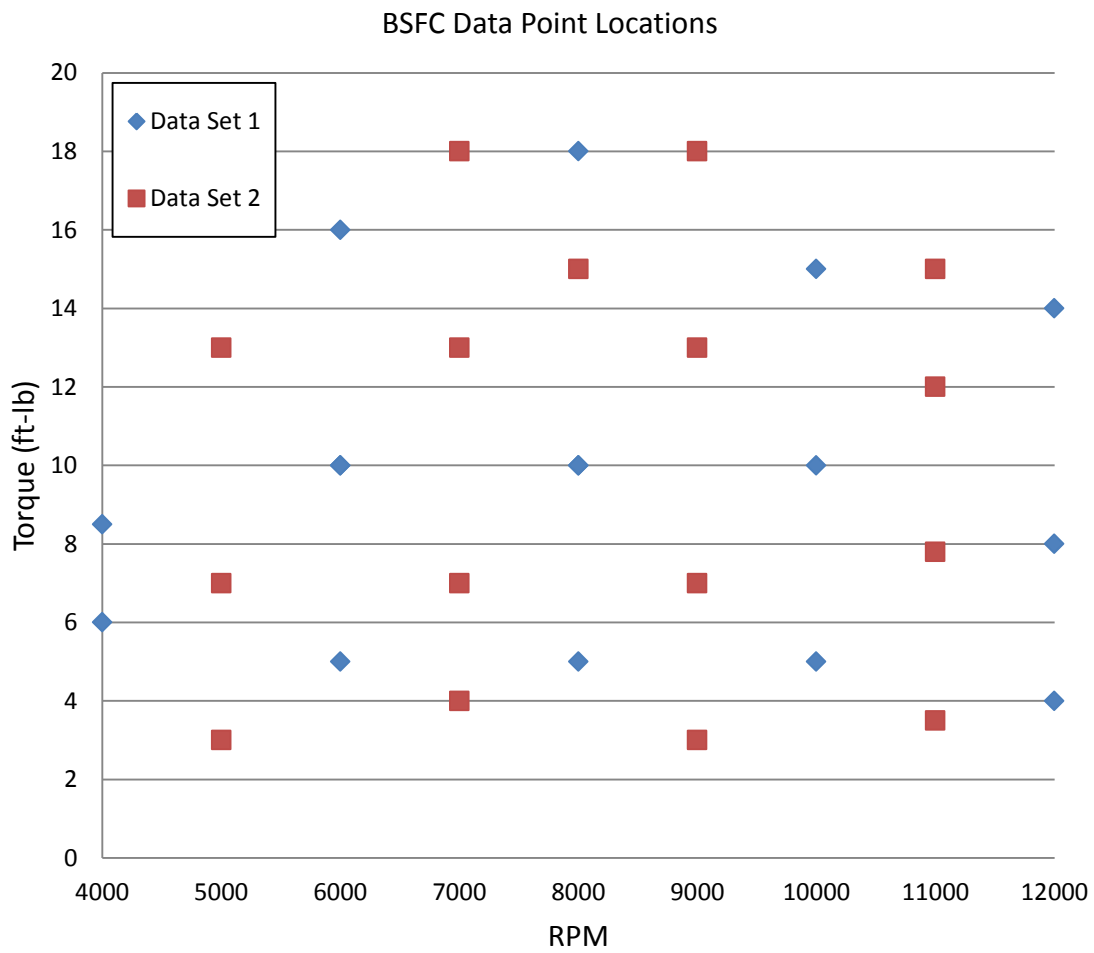
**Figure 26: Steady state torque and hp vs. rpm.**

Figure 27 shows the quasi-dynamic WOT sweep. The automated test ran on the dynamometer began by setting the rpm at 5000 then increased throttle until WOT. The program then gradually increased the set rpm while gathering data points. This showed a very similar curve as the steady state measurement. It gives a more realistic indication as to how an accelerating vehicle would behave but is not truly a dynamic test.



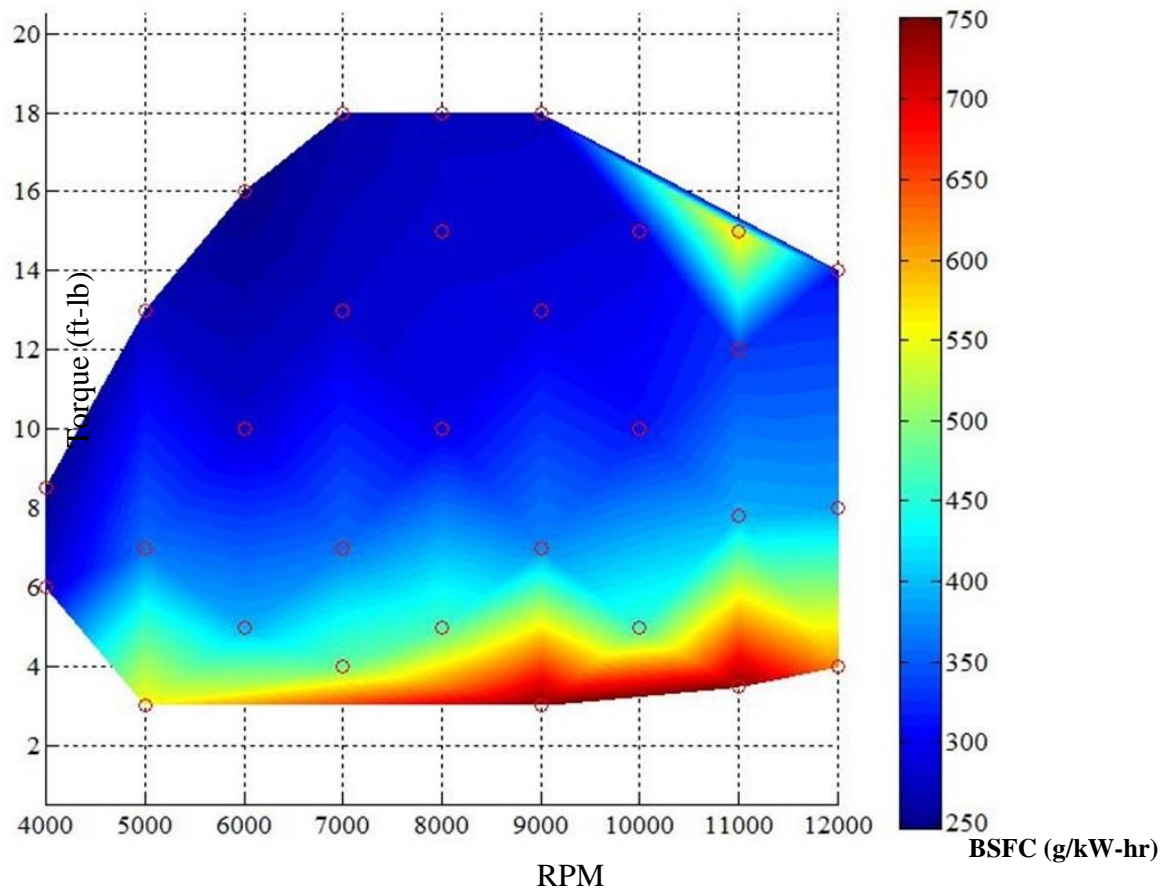
**Figure 27: Automated WOT sweep torque and hp vs. rpm.**

Steady state fuel consumption was measured at various rpm and torque location. The data consists of 32 data points every 1000 rpm from 4000 rpm to 12000 rpm. The torque values were offset each 1000 rpm creating the grid pattern shown in Figure 28. To measure fuel consumption, the torque and rpm were set, and then the mass of fuel used during a 30 second period was recorded in kilograms. Knowing the engine speed, torque, and fuel used over a set amount of time, the brake specific fuel consumption (BSFC) could then be calculated. The BSFC for each point was input into Matlab to create a three-dimensional surface. The interpolation between each data point is a simple linear approximation. Figure 29 shows the BSFC map created in Matlab.



**Figure 28: BSFC data point locations.**

## Brake Specific Fuel Consumption



**Figure 29: Brake specific fuel consumption.**

### Drag Strip Test

With the results from the roll-down test, ICE bench testing, and frontal area calculation, the model was updated with accurate data. Using this updated model, the simulations could be compared to vehicle tests. The first event of the competition is the 250 foot acceleration event. At the competition, this event is conducted in both electric-only mode and hybrid mode. In addition to these modes that occur at the competition, the performance model will also calculate ICE-only acceleration times. To test these predictions the vehicle was put through a simulated acceleration event. The competition uses transponders to measure times, but the team did not possess the equipment to utilize the transponders, thus the vehicle was timed with a stopwatch. The vehicle begins from a standstill and accelerates 250 feet. Timing

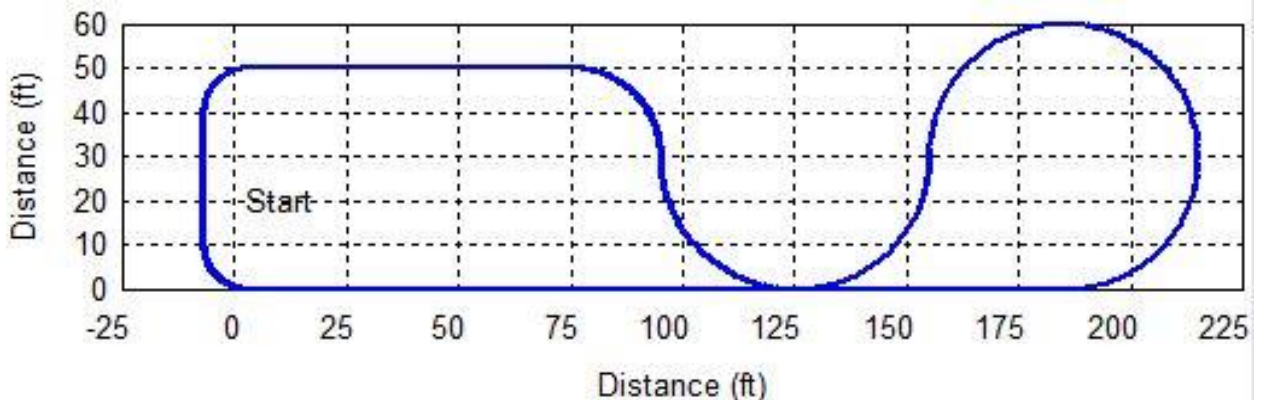
began with movement of the vehicle and stopped as the vehicle crossed the 250 foot mark. The times are reported in Table 3.

**Table 3: Acceleration Times**

Mode	Empirical Time (seconds)	Performance Model Prediction (seconds)
ICE Only	6.6	7.6
Electric Only	6.4	7.8
Hybrid	5.0	5.3

**Autocross Test**

One primary aspect of the performance model is to simulate laps around a track. A track of any geometry can easily be input to the model and theoretical lap times as well as fuel consumption estimates are output. To validate the performance model, as well as test the vehicle, a small track was layed out in an empty parking lot on the UI campus. The track was also input into the performance model allowing the resulting lap times and fuel consumptions to be compared. Figure 30 shows the lap from the TK Solver model.



**Figure 30: Test track layout.**



The vehicle was tested in two modes, ICE-only and hybrid. The testing included two runs for each mode, one at full race speed and one at a more conservative pace. Each run was nine laps traveling counterclockwise around the track for a total distance of one mile. To measure the fuel consumption of the vehicle under these operating conditions the fueling system was emptied, then refilled with a known volume of fuel. After each run the fueling system was then emptied again and measured. The distance traveled for each run was one mile thus the mpg was easily calculated for each run.

For the ICE-only mode, the average lap time of the first run was 20.4 seconds with a fastest lap of 19.4 seconds. The average lap time of the second run was 24.1 seconds with the fastest lap of 22.5 seconds. The fast run showed an efficiency of 17.6 mpg and the more conservative run showed a better efficiency of 21.6 mpg. The performance model predicted lap times of 18.8 seconds for ICE-only mode, only one second faster than the best recorded time. Fuel consumption predicted by the model, using the single average point method of 350 g/kw-hr estimation, produced an output of 22.0 mpg. The 350 g/kw-hr estimation is a result of averaging the fuel consumption measurements for all operating points. The results of the simulated laps are summarized in Table 4.

**Table 4: ICE-Only Autocross Test Data**

	<b>Average Lap Time (s)</b>	<b>Fastest Lap (s)</b>	<b>Efficiency (mpg)</b>	<b>Average Engine Speed (rpm)</b>	<b>Max Engine Speed (rpm)</b>
<b>Run 1 (Fast)</b>	20.4	19.4	17.6	7332	12728
<b>Run 2 (Slow)</b>	24.1	22.5	21.6	5826	7537
<b>Performance Model Prediction</b>	18.8	18.8	22.0	11485	13650

For hybrid mode, the average lap time of the fast run was 19.9 seconds with a fastest lap of 18.6 seconds. The average lap time of the second run was 25.3 seconds with the fastest lap of 24.1 seconds. The fast run showed an efficiency of 23.6 mpg and the more conservative run showed an efficiency of 18.3 mpg. The performance model predicted lap times of 18.5 seconds for hybrid mode, only 0.1 seconds faster than the best recorded time. Fuel consumption predicted by the model, using the single average point method of 350 g/kw-hr estimation, produced an output of 24.6 mpg. The results of the simulated laps are summarized in Table 5.

**Table 5: Hybrid Autocross Test Data**

	<b>Average Lap Time (s)</b>	<b>Fastest Lap (s)</b>	<b>Efficiency (mpg)</b>	<b>Average Engine Speed (rpm)</b>	<b>Max Engine Speed (rpm)</b>
<b>Run 1 (Fast)</b>	19.9	18.6	23.6	4367	9755
<b>Run 2 (Slow)</b>	25.3	24.1	18.3	3587	5009
<b>Performance Model Prediction</b>	18.5	18.5	24.6	11450	13660

For the hybrid mode laps, it can be assumed that the performance of the batteries operated on the quasi-steady-state linear portion of their discharge curve. Any drop in voltage is a good indicator of capacity usage for the batteries. The fast hybrid run saw a drop in voltage of the battery pack from 116.5V to 113.6V, a 2.9V drop. The drop in voltage of the second run was from 113.6V to 110.1V, a 3.5V drop. It can be seen that the second run used approximately 0.6V more than the first run, indicating more battery power was used on the second run than the first.

A performance model was created to design a hybrid vehicle that would be optimized for the Formula Hybrid SAE competition. The model used information from the vehicle's physical characteristics and powertrain to simulate its performance in the dynamic events of the competition. The model also allowed the user to design the track on which the vehicle would be simulated. Plotting the track in the model provided a means to compare the model with tests on a physical track, and in the future will allow teams to predict the vehicle's performance of a race before driving. When the previous vehicle was designed, a model was not used to configure the systems to score the most points possible. For the 2014 vehicle, however, the performance model was used to make a number of the design decisions:

- Selection of the battery brand and model
- Determination of the energy allocation between gasoline and battery power
- Coupling the ICE and EM post-transmission rather than pre-transmission as in the 2012 vehicle

The resulting vehicle design was then constructed and tested to validate the model's accuracy. Tests measured parameters that would be model inputs, such as rolling resistance, ICE power curve, and frontal area, as well as model outputs, such as acceleration time, autocross time, and fuel consumption. Based on the differences between the model's predicted times and efficiencies and the data from testing, there are a few apparent areas for improvement.

## **Testing and Modeling**

The roll-down test discovered a total rolling resistance coefficient for this vehicle, but does not indicate where the likely sources of the highest resistance occur. Repeating the roll-down test with various components altered would give a much better indication of where the team should apply design resources. The following changes should be investigated when repeating the roll-down test:

- Removing the residual pressure valves
- Without the brake pads depressed onto the rotors
- Replacing the Rekluse clutch with the stock clutch

- At various tire pressures
- Beginning the test at various elevations to reach different maximum speeds

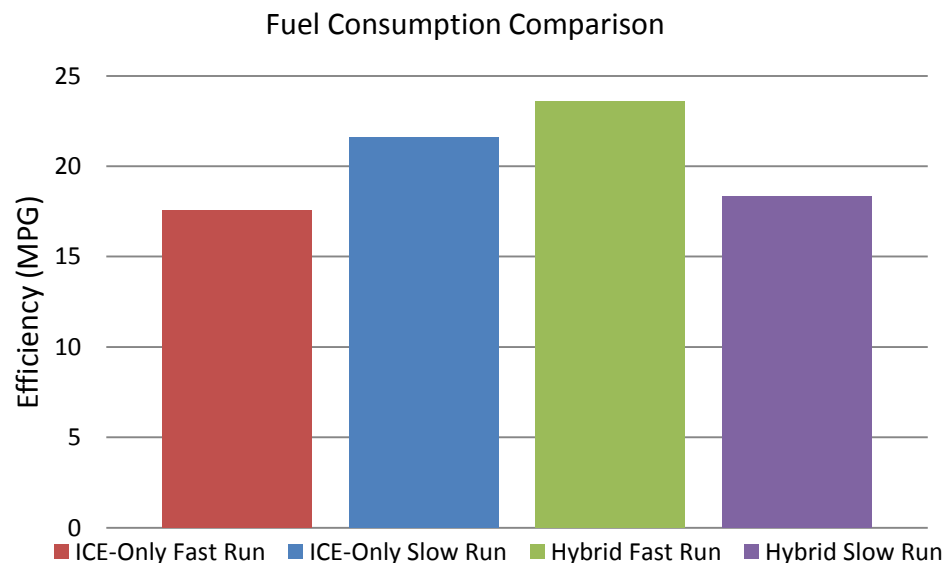
If the rolling resistance coefficient changes drastically at various tire pressures and speeds, then the value could be changed to be dependent on those values rather than a constant value.

Comparison of the acceleration times predicted by the mathematical model to the times achieved in testing shows a slight difference. The model under-predicted the acceleration time of each mode, ICE-only, electric-only, and hybrid. The shifter was not operational during hybrid testing; therefore the discrepancy would only become larger considering the event should use four shifts to produce the best run possible. It is not obvious where the discrepancy lies. To account for the discrepancy, future work may further investigate and confirm the vehicle measurements used in the model such as the EM torque curve, however, additional analytical considerations may need to be included such as weight transfer due to acceleration and tire grip changing with temperature. The initial assumption is that the EM is producing much more power than its specifications indicate, but the ICE-only acceleration run was also faster than the model predicted; therefore the model must have some efficiencies and/or calculations that are too conservative. It was not in the scope of the project to edit the governing equations of the model; however, based on these findings doing so is most likely the next step.

Autocross times were very close to the model's prediction; however, the model achieved its time with the use of shifting gears. The shifter was not operating correctly during testing; therefore, all testing was done in third gear. Even by staying in a single gear, the vehicle was able to produce times almost exactly to what the model predicted. This indicates that had the shifter been working, faster times may have been achieved, and that the autocross testing would resemble the acceleration testing in that the vehicle out-performed the model's predictions. One possibility is that a more detailed analysis of the suspension system in the model is needed to improve accuracy. At the moment, the mass of the vehicle is analyzed as a point mass. There is no consideration of weight transfer through the suspension, spring rate and damping rate of the shocks, preload of the shocks, tire pressure, or tire heating and how this would affect the performance of the events. Additionally the vehicle is modeled as

braking before a corner, holding a constant acceleration through the corner, and accelerating after the corner is completed. Though this is a decent assumption, realistic driving brakes during the corner, possibly using scrub resistance to help brake, then accelerates out of the corner. In addition to providing more accurate simulations, by including a dynamic weight transfer and cornering model, analysis of optimal suspension configurations could be done to determine the best setup for a particular course. This would be valuable to the team during race day where the model could be applied to a course the vehicle has yet to run and adjustable suspension settings could be determined before any driving occurred.

Fuel consumption measurements were taken for four different test runs, two in hybrid mode and two in ICE-only mode. To measure the fuel used during each run the fuel system was emptied and filled with a measured amount of fuel. After the run the fuel system was emptied again and the difference could be measured. This measurement then could be used to calculate the fuel economy. Figure 31 shows a graph of the efficiencies.



**Figure 31: Fuel consumption data.**

It can be seen that the fast ICE-only run used more fuel than the slow ICE-only run. This is the intuitive result expected. The hybrid runs, however, show a different trend. The fast hybrid run, which was the fastest of any run, was also the most efficient of any run. The

slower hybrid mode run was less efficient. This is not intuitive, but other measurements support it. During the slow hybrid run the voltage drop was much greater than during the fast hybrid run. This indicates that the EM was taking on more load than in the fast run, yet the speed of the vehicle was slower. During the slow run the ICE was at a slower engine speed. Also, the battery voltage indicates the load on the ICE was less than the previous run. From the BSFC testing on the dynamometer, it can be seen that at low load and low engine speed the ICE is at a more inefficient operating point than at higher load and speed. This shows that to optimize fuel efficiency the vehicle needs to be operated such that the load is between 10 ft-lbs and 18 ft-lbs and the engine speed is between 5000 rpm and 9000 rpm. This is controlled by the driver shifting and throttling the vehicle appropriately.

The design of this particular vehicle was based on the 2014 Formula Hybrid SAE competition rules. Analysis using the performance model lead to the selection of a high discharge rate, yet low capacity batteries, resulting in a lightweight design that performs well in the short distance events, but will not last through the endurance race. For the 2014 competition, there is discussion of changing some aspects of the competition, for example extending the endurance event to 44 km from the previous 22 km length. This would be a cause to reevaluate the design and possibly make changes such as increasing the battery capacity.

If the current vehicle during the race were to achieve the fuel consumption indicated during testing, it would just barely finish the endurance race. That, however, could change based on the track design. Testing confirmed that an average point constant fuel consumption model is not an accurate means to predict the course. The average point estimation changes drastically based on the conditions and the manner in which the vehicle is driven. A much more accurate analysis would include the fuel consumption data from the BSFC measurements on the dynamometer. This would allow the model to calculate the fuel consumption dynamically as it stepped through its iterations at each load and engine speed along the track. In this way the fuel used could be predicted much more accurately. This would be critical when evaluating a longer endurance event. Further testing would have to confirm the BSFC measurements to account of the increased fuel consumption during acceleration that the dynamometer measurements would not reflect.

One particular change that would be beneficial in most all cases would be regenerative braking. The current design will not operate in hybrid mode for the entirety of the endurance event; the batteries would run out of energy before the race would be finished. Through testing, the ICE has shown that should be efficient enough to complete the endurance event without assistance from the EM for the whole race; however, allowing the EM to be used longer would only increase speed and therefore cause the vehicle to earn a higher score. Including this regenerative braking into the model would be necessary if such a system were implemented in future vehicles, which is suggested in the last section of this report.

The terrain of the endurance run track also supports the implementation of regenerative braking. There are large changes in elevation which are excellent features for a system with regenerative braking. This also, however, would need to be included into the model. Current consideration of grade is a constant value, meaning that any input of grade effects all calculations continuously through the course. The physical track is not a constant grade, but includes downhill sections as well. Including a dynamic grade portion to the track plotting feature would allow much more accurate prediction of times and fuel consumption. The grade values would have to be calculated based on the real track, and then input along with the rest of the user input data of the course.

## **Current Vehicle Suggestions**

From testing the vehicle there are many modifications that could be suggested be completed before the competition. In order to utilize the potential of the ICE it is imperative that the vehicle be able to consistently shift gears. At present the shifter is temperamental at best, rarely allowing downshifts and not always responding to up-shifts. This problem should be addressed immediately.

The current method to check the fuel level involves looking into the tank after removing the cap. This is not only inaccurate and unprofessional, but will not be allowed during the endurance race. A fuel gauge is necessary to add to the vehicle. A simple sight tube would suffice and could be installed quickly.

At the competition, it is important to know which team members will drive in each event. Previously these decisions were made fairly arbitrarily. With a consistently operational vehicle, there is an opportunity to gather driver statistics. Knowing which team members will produce the most consistent times is very valuable and should control the choice of driver for a particular event. In addition, training each driver on all procedures involving the competition and rules should happen while driver data is being gathered. Preparedness is a trait that is not available to many teams at the competition, but this year the UI is further along than any previous year. The opportunity to be well trained and practiced should be taken seriously.

One 12 volt battery powers all the on-board components of the vehicle such as the ECU, ignition module, shifter, battery management system, and isolation relays. In addition, the single battery powers the engine starter. When the engine starter is turned over, the battery voltage temporarily droops to approximately 9 volts. If the high voltage isolation relays are closed at the time the starter is turned over, the voltage droop causes the relays to open as they require 12 volts to stay shut. This creates a hassle during the startup procedure as it requires the ICE to be running before the EM can be operated. One technique that would be desirable to use is being able to start the ICE while driving in electric-only mode. This cannot happen at present and needs to be addressed. One option is to operate the starter from a separate battery than the rest of the low voltage systems. Another option is to incorporate a capacitor with the relays preventing them from opening immediately once they lose sufficient power to keep them closed.

In addition to these suggested changes to the current vehicle, there are some notable rule changes that need to be addressed including a change in total allotted fuel and the banning of using header wrap. In general all rule changes need to be examined such that the technical inspection can be passed quickly at competition. Having to make changes to any system at the competition is a huge hassle and threatens the ability of the team to be prepared for all the events. Affirming the vehicle passes technical inspection before leaving for the competition is a vital step in the success of the team.



## **Future Vehicle Suggestions**

The majority of the time spent on this research was not testing and analysis, but construction and maintenance on the vehicle. Throughout the process there have been opinions formed about where future teams should focus their design efforts. These include regenerative braking, stock fuel injection, stock engine case, and minimizing mechanical interface between ICE and EM (or possibly EM only).

At the last three hybrid competitions that the UI has sent team members to, 2011, 2012, and 2014, all three times the representatives of the major auto makers such as Ford and GM have indicated they will not give out their awards to a team that does not utilize regenerative braking. Their message indicated not only where the industry is going, but makes sense. Using the light-weight high discharge pouch cells was a good start, but implementing regeneration to extend their life through an event like the endurance race is the obvious next step. Doing so would improve the score of the race by a significant amount. It should be made a priority to design and implement a regenerative braking system to extend the battery life of the vehicle.

If regenerative braking were to be implemented, it should occur in the front wheels. This is obvious as up to 70 percent of the braking occurs with the front wheels. The existing powertrain would not be affected by installing a separate front powertrain, but if this were to happen, all the electric power should be separated from the ICE and moved to the front. Having two separate powertrains, electric in the front and ICE in the rear, would not only make things easier from the pragmatic view of maintenance and installation, but separate failure points and decrease the risk of powertrain failure. With the current system, any component failures downstream of the output shaft (between the wheels and the output shaft) would mean neither the EM nor ICE could drive the vehicle. Having a hybrid coupled through the road, and not by any mechanical methods, would mean total failures of either system could occur and the car would still be operational. Additionally having four-wheel drive spreads out the applied torque and can prevent loss of traction due to breaking loose on acceleration.

Utilizing regenerative braking is an imperative step to take in hybrid technology, but also in electric-only vehicles. Logistically speaking it makes much more sense for the UI to attend the Formula SAE competition in Lincoln, Nebraska than the Formula Hybrid SAE competition in Loudon, New Hampshire. Under the assumption that funding would only be available to either a hybrid vehicle, or an electric vehicle, it is sensible to consider moving the program down the electric vehicle path. This would simplify traveling logistics, cost less, and encourage interdepartmental cooperation. If this were to happen, utilizing regeneration would still be a necessary design feature, and it could be used on all four tires rather than just the front two. Work is already being done to design the electric-only powertrain, but resources need to be put forward to begin designing the regenerative braking system.

By converting the YZ250F from a carburetor to fuel injection, the UI increase the efficiency of the ICE and power over most operating points; however, there are many models of 250cc motorcycle engine that have fuel injection now. Any WR250X after 2008 comes with fuel injection and electric start. Even the new 2014 models of YZ250F and YZ450F are fuel injected. For the standard combustion competition, FSAE, there is an air restrictor requiring the re-tuning of any fuel injections system. The hybrid competition, however, does not have an air restrictor. This means that a stock injection system, with a stock ECU could be utilized. Additionally, the current fueling system does not inject close enough to the port of the intake valve and condenses to liquid in the intake runner. This liquid then goes through the engine without combusting and is very detrimental to the efficiency of the ICE. Because the cylinder head of the current engine is rotated back, and that the differential is incorporated into the engine case, there is no way to relocate the injector any closer. Using an OEM system would result in reliable fueling that starts, idles, and accelerates with increased efficiency. According to the official EPA efficiency released by Yamaha the 2009 WR250X has an efficiency of 71 mpg for the 299 pound motorcycle [5]. Therefore, if the UI continues to attend the hybrid competition, it is imperative to use a stock engine and fueling system in future designs.

Currently a centrifugal clutch made by Rekluse is used in the vehicle. This choice was made because it eliminated a user control, simplifying the system for the driver; however, there have been technical issues with using this after-market clutch system. The Rekluse does not

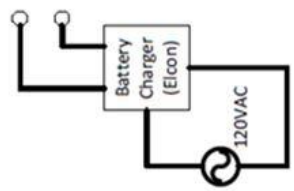
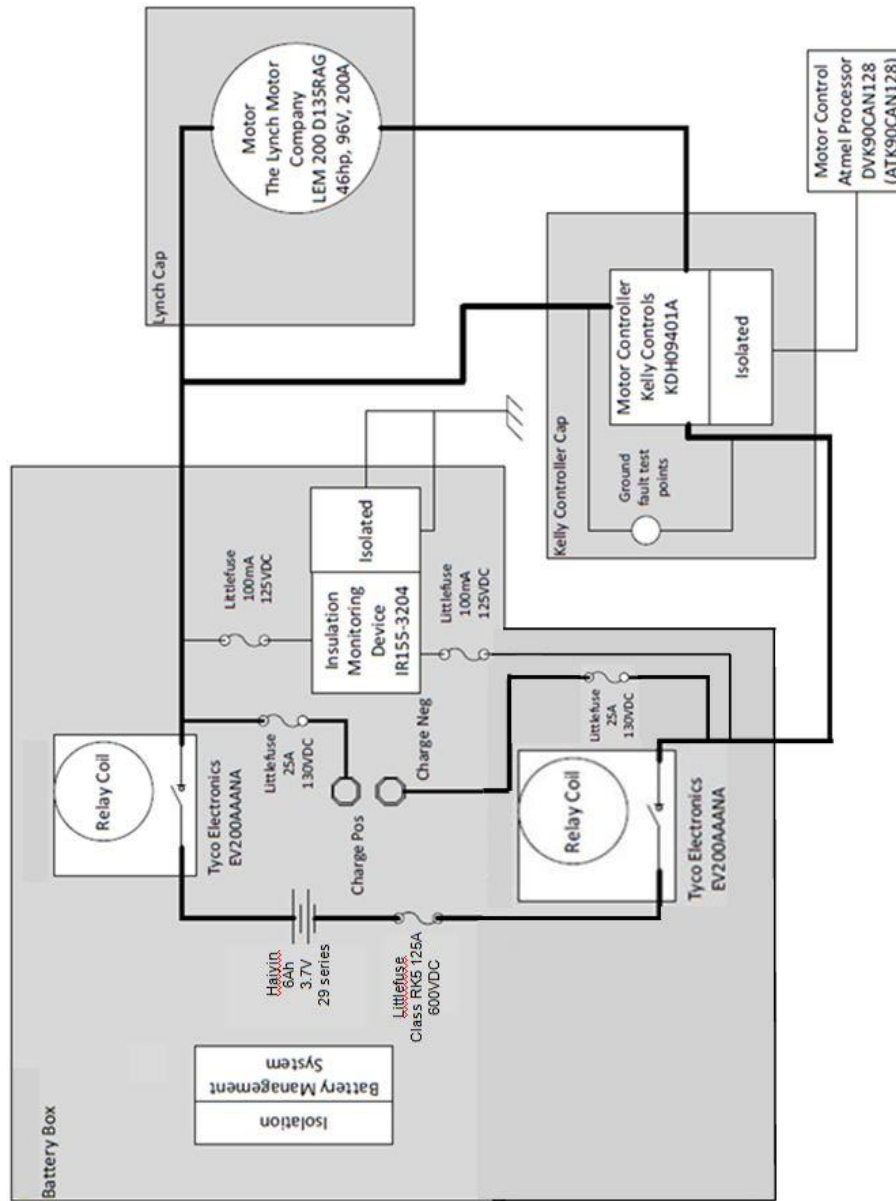
begin to disengage effectively until it has been sufficiently warmed up. This can occur much later than when the engine itself is warmed up and ready for operation. Additionally, removing the driver's option to manually engage the clutch removes the ability to increase the ICE rpm before launching, a potentially very useful technique in the drag races. In future vehicles, moving back to using an OEM manual clutch would help not only the ease of operation, but in performance of the vehicle as well.

## REFERENCES

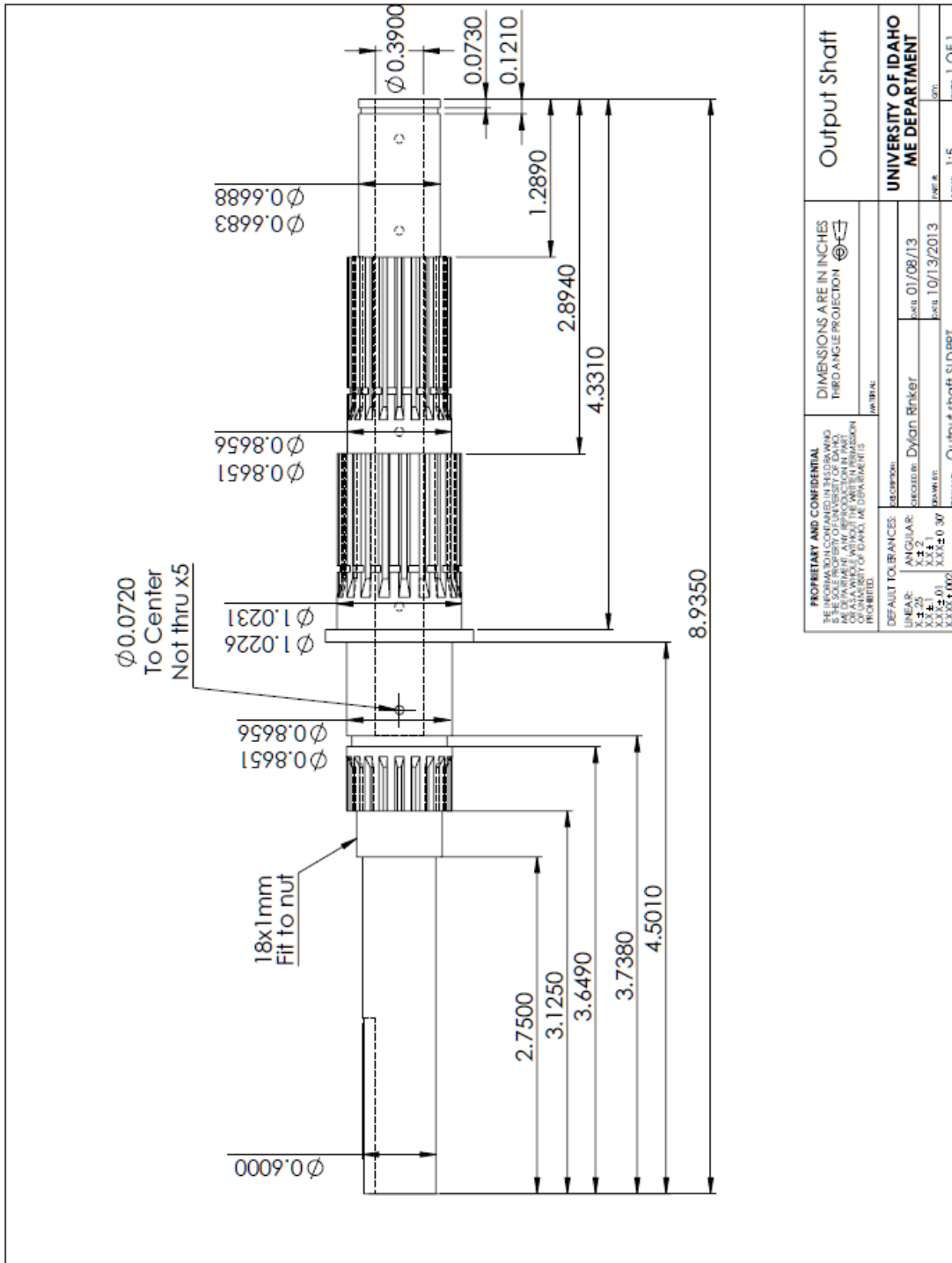
- [1] S. H. Wos, "Hybrid Vehicle Mathematical Modeling & Drive Cycle Simulation," University of Idaho, Moscow, 2012.
- [2] B. Butsick, "Design and Mathematical Modeling of a Hybrid FSAE Drivetrain," University of Idaho, Moscow, 2011.
- [3] Formula Hybrid SAE Rules Committee, "Important Documents," 2014. [Online]. Available: <http://www.formula-hybrid.org/pdf/Formula-Hybrid-2014-Rules.pdf>. [Accessed 09 07 2014].
- [4] The Lynch Motor Company, "Motor Specifications," [Online]. Available: <http://www.lmcltd.net/uploads/files/data%20sheet%20for%20LMC%20Motors.pdf>. [Accessed 09 07 2014].
- [5] Yamaha Motor Corporation, "Specifications," [Online]. Available: <http://www.yamahamotorsports.com/sport/products/modelspecs/66/0/specs.aspx>. [Accessed 13 October 2014].

**APPENDIX A: DRAWINGS AND SPECIFICATIONS**

High Voltage Wiring Diagram



Output Shaft Drawing



Electric Motor Specifications

Motor	No Load Current A	Torque Constant Nm/A	Speed Constant Rpm/V	Armature Resistance DC mΩ	Armature Inductance @ 15kHz μH	Armature Inertia Kg·m <sup>2</sup>	Peak Power kW	Peak Efficiency %	Peak Current A	Rated Power kW	Rated Speed Rpm	Rated Voltage V	Rated Current A	Rated Torque Nm
95	6	0.113	76	21.5	22	0.0238	18	89	400	6	3200	48	175	19
126	10	0.0737	105	175	6	0.0234	7.59	83	400	5.06	2520	24	270	19.2
127	5	0.15	54	22.5	23	0.0236	16.08	88	400	8.55	2592	48	215	31.5
D95B	6	0.14	66	20.5	11	0.0238	28.50	91	400	15.00	6000	72	200	30.0
D126	5	0.0748	100	138	5	0.0234	11.14	81	400	6.91	3600	36	250	18.3
D127	4	0.17	50	17.5	13	0.0236	25.38	90	400	12.56	3600	72	200	33.3
D135	3.5	0.185	45	16.75	16	0.0236	29.04	90	400	14.39	3780	84	200	36.4
D135RAG	7.36	0.207	42	16.95	16	0.0238	34.32	91	400	16.84	4032	96	200	39.88
D135RAGS	7.45	0.21	40	16.95	16	0.0238	36.00	91	400	18.00	4400	110	200	42.00

Any model of the LEM-200 can be made up into the 2X2 version this is 2 motors married together on a single shaft see installation drawing for details  
 New V-twin model available for increased power, larger motor in development for mid 2012  
 Torque Output of Motor; J [Nm] = Kt [Nm/A] \* ( Current [A] - No Load Current [A] )

LMC reserves the right to change this information without prior notice



**APPENDIX B: RAW TESTING DATA**

---

**Steady State ICE Fuel Consumption Data**

Fuel:  
6/6/13 E10 No temperature compensations (air or engine)

Data Point	RPM	Torque (ft-lbs)	bsfc (g/kw-hr)	HP	kW	TP	lambda	fuel used (kg)	time (s)	fuel rate (kg/hr)
1	4000	6	281.72	4.57	3.41	9	0.89	0.008	30	0.96
2	4000	8.5	248.58	6.47	4.83	20	0.89	0.01	30	1.2
3	6000	5	394.41	5.71	4.26	13	0.86	0.014	30	1.68
4	6000	10	281.72	11.42	8.52	28	0.86	0.02	30	2.4
5	8000	5	464.84	7.62	5.68	18	0.84	0.022	30	2.64
6	8000	10	295.81	15.23	11.36	31.5	0.9	0.028	30	3.36
7	10000	5	456.39	9.52	7.10	26	0.9	0.027	30	3.24
8	10000	10	312.71	19.04	14.20	41	0.91	0.037	30	4.44
9	12000	4	616.27	9.14	6.82	37	0.9	0.035	30	4.2
10	12000	8	387.37	18.28	13.63	50	0.87	0.044	30	5.28
11	6000	16	246.51	18.28	13.63	100	0.85	0.028	30	3.36
12	8000	18	275.85	27.42	20.45	100	0.85	0.047	30	5.64
13	10000	15	287.36	28.56	21.30	100	0.9	0.051	30	6.12
14	12000	14	311.91	31.99	23.85	100	0.84	0.062	30	7.44
15	6000	10	309.89	11.42	8.52	30	0.81	0.022	30	2.64
16	8000	10	306.37	15.23	11.36	31	0.88	0.029	30	3.48

6/7/13 Fuel: E10 No temperature compensations (air or engine)

Data Point	RPM	Torque (ft-lbs)	bsfc (g/kw-hr)	HP	kW	TP	lambda	fuel used (kg)	time (s)	fuel rate (kg/hr)
17	5000	3	563.44	2.86	2.13	7	0.83	0.01	30	1.2
18	5000	7	362.21	6.66	4.97	16.5	0.93	0.015	30	1.8
19	5000	13	273.05	12.38	9.23	100	0.85	0.021	30	2.52
20	7000	4	482.95	5.33	3.98	12.5	0.83	0.016	30	1.92
21	7000	7	362.21	9.33	6.96	22.5	0.82	0.021	30	2.52
22	7000	13	278.63	17.33	12.92	39	0.855	0.03	30	3.6
23	9000	3	751.26	5.14	3.83	16	0.84	0.024	30	2.88
24	9000	7	375.63	12.00	8.94	26	0.86	0.028	30	3.36
25	9000	13	288.95	22.28	16.61	49	0.88	0.04	30	4.8
26	11000	3.5	746.38	7.33	5.47	30	0.82	0.034	30	4.08
27	11000	7.8	394.02	16.34	12.18	41	0.84	0.04	30	4.8
28	11000	12	332.94	25.13	18.74	67	0.86	0.052	30	6.24
29	11000	15	578.81	31.42	23.43	100	0.84	0.113	30	13.56
30	9000	18	276.50	30.85	23.00	100	0.88	0.053	30	6.36
31	7000	18	261.60	23.99	17.89	100	0.86	0.039	30	4.68
32	8000	15	281.72	22.85	17.04	52	0.85	0.04	30	4.8

**ICE-Only Track Testing Data**

8/7/2013

ICE Only Run 1; Autocross style driving, rpm 5000-12000

Lap	Time (s)	Start (mL)	Final (mL)	Used (mL)	Used (gal)
1	23.7	300	85	215	0.057
2	19.7				
3	19.5	Lap (ft)	Total (ft)	Total (mile)	MPG
4	19.4	585	5265	1.00	17.6
5	20.4				
6	20.2	AvgTime (s)	Fast Lap (s)	Avg Speed (ft/s)	
7	20.2	22.0	19.4	26.6	
8	20				
9	35				

8/7/2013

ICE Only Run 2; Endurance style driving, taking it easier, rpm 4000-7000

Lap	Time (s)	Start (mL)	Final (mL)	Used (mL)	Used (gal)
1	26.7	290	115	175	0.046
2	24.1				
3	24.2	Lap (ft)	Total (ft)	Total (mile)	MPG
4	24.1	585	5265	0.9972	21.6
5	23.5				
6	22.5	AvgTime (s)	Fast Lap (s)	Avg Speed (ft/s)	
7	24	24.1	22.5	24.3	
8	23.8				
9	24.2				

**Hybrid Track Testing Data**

10/9/2013

Hybrid Run 1; Autocross style driving, rpm 5000-12000

Lap	Time (s)	Start (mL)	Final (mL)	Used (mL)	Used (gal)
1	22.7	300	140	160	0.042
2	19.23				
3	19.1	Lap (ft)	Total (ft)	Total (mile)	MPG
4	19.66	585	5265	1.00	23.6
5	20.59				
6	19.22	AvgTime (s)	Fast Lap (s)	Avg Speed (ft/s)	Voltage Drop (V)
7	18.63	19.9	18.6	29.4	2.9

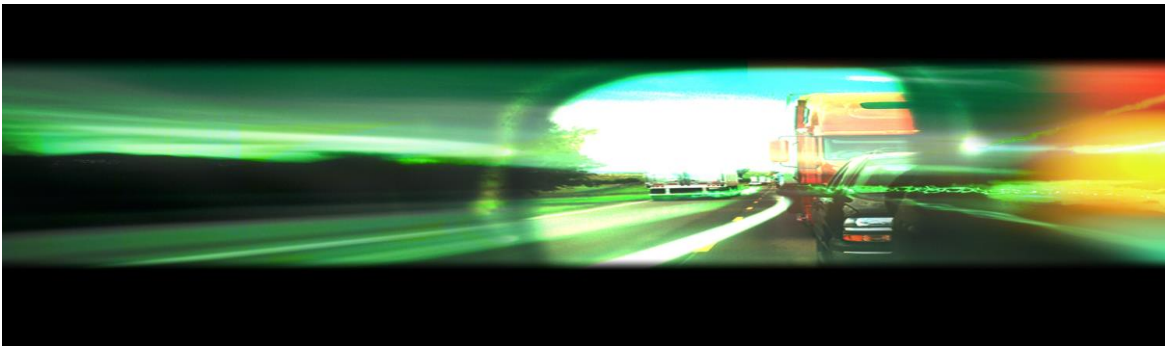
10/9/2013

Hybrid Run 2; Endurance style driving, taking it easier, rpm 4000-7000

Lap	Time (s)	Start (mL)	Final (mL)	Used (mL)	Used (gal)
1	28.27	300	140	160	0.042
2	24.05				
3	25.67	Lap (ft)	Total (ft)	Total (mile)	MPG
4	25.35	585	4095	0.8	18.3
5	24.93				
6	24.65	AvgTime (s)	Fast Lap (s)	Avg Speed (ft/s)	Voltage Drop (V)
7	24.47	25.3	24.1	23.1	3.5

**DESIGN OF THE 2014 UNIVERSITY OF IDAHO  
FORMULA HYBRID VEHICLE**

**Final Report**



**TranLIVE**

**Rory Lilley, Dr. Mostafa Asfoor, Dr. Michael Santora,  
Dr. Dan Cordon, Dr. Odom Edwin, Dr. Steven Beyerlein**

**November 2014**

## DISCLAIMER

The contents of this report reflect the views of the authors, who are responsible for the facts and the accuracy of the information presented herein. This document is disseminated under the sponsorship of the Department of Transportation, University Transportation Centers Program, in the interest of information exchange. The U.S. Government assumes no liability for the contents or use thereof.

1. Report No.	2. Government Accession No.	3. Recipient's Catalog No.	
4. Title and Subtitle Design of the 2014 University Of Idaho Formula Hybrid Vehicle (Year 2)		5. Report Date November 2014	
		6. Source Organization Code KLK908	
7. Author(s)  Lilley, Rory; Asfoor, Dr. Mostafa; Santora, Dr. Michael; Cordon, Dr. Dan; Odom, Dr. Edwin; Beyerlein, Dr. Steven		8. Source Organization Report No. N14-21	
9. Performing Organization Name and Address  TranLIVE University of Idaho, NIATT 875 Perimeter Dr. MS0901 Moscow, ID 83844-0901		10. Work Unit No. (TRAIS)	
		11. Contract or Grant No. DTRT12GUTC17	
12. Sponsoring Agency Name and Address US Department of Transportation Research and Special Programs Administration 400 7th Street SW Washington, DC 20509-0001		13. Type of Report and Period Covered Final Report: August 2013 – October 2014	
		14. Sponsoring Agency Code USDOT/RSPA/DIR-1	
15. Supplementary Notes:			
16. Abstract Over the last five years the Vandal Hybrid Racing team at the University of Idaho has developed a compact, lightweight, and mass centralized vehicle design with a rule-based energy management system. Major areas of innovation included an upright, spindle, and braking system that dramatically reduced rolling resistance, a close fitting frame design made possible by locating major components (engine, battery box, electric motor, and gas tank) close to the ground and to the center of gravity. The vehicle also incorporates a trailing link suspension, and realization of a rule-based energy management system that oversees operation of a Lynch electric motor as well as a YZ250F engine that is housed in a custom crankcase. The vehicle described in this paper won the 2014 FHSAE competition in Loudon, New Hampshire. It is currently undergoing comprehensive performance testing that will inform the design and operation of a next generation vehicle.			
17. Key Words SAE Formula Hybrid Competition, Parallel Hybrid Powertrain, Energy Management		18. Distribution Statement Unrestricted; Document is available to the public through the National Technical Information Service; Springfield, VT.	
19. Security Classif. (of this report) Unclassified	20. Security Classif (of this page) Unclassified	21. No. of Pages 25	22. Price



**TABLE OF CONTENTS**

EXECUTIVE SUMMARY .....	1
DESCRIPTION OF PROBLEM.....	2
APPROACH AND METHODOLOGY .....	4
Control System.....	5
High Voltage System .....	5
Internal Combustion Engine .....	9
User Interface.....	12
FINDINGS; CONCLUSIONS; RECOMMENDATIONS .....	14
Engine Simulation and Testing.....	14
Vehicle Testing .....	16
2014 Competition Vehicle .....	18
Future Work .....	18
REFERENCES .....	20
APPENDIX A.....	21
APPENDIX B .....	25

**FIGURES**

Figure 1: Overall vehicle layout. ....	2
Figure 2: Energy Management System control loop. ....	4
Figure 3: Vehicle control scheme. ....	5
Figure 4: Inertial dynamometer used for electrical testing. ....	6
Figure 5: Electric motor torque curve.....	7
Figure 6: Fully assembled battery pack. ....	7
Figure 7: Finite element analysis showing the bottom of the battery box.....	9
Figure 8: Bosch 32mm throttle body. ....	11
Figure 9: Three dimensional pot of viable Helmholtz Resonator dimensions.....	12
Figure 10: User interface. ....	13
Figure 11: Experimental BSFC map.....	14
Figure 12: Theoretical BSFC map. ....	15
Figure 13: Original roll down test conducted. ....	16

Figure 14: Second roll down test with new brake design. .... 17  
Figure 15: University of Idaho 2014 SAE Formula Hybrid Vehicle..... 18

**TABLES**

Table 1: Relative Error of Two Phase Engine Model..... 15  
Table 2: General Statistics of the Vehicle..... 18

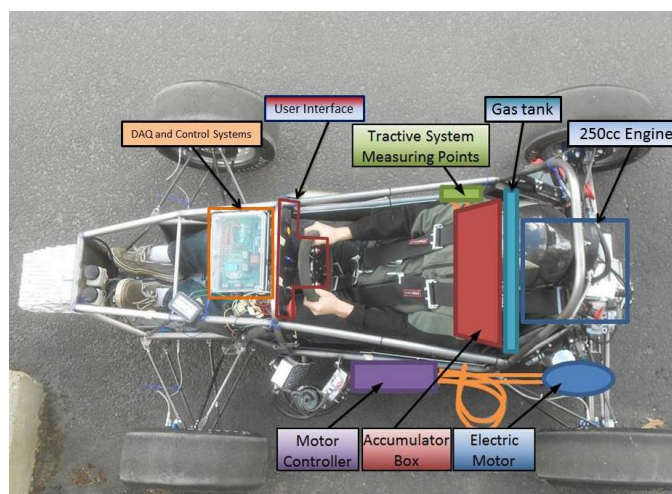
## **EXECUTIVE SUMMARY**

Over the last five years the Vandal Hybrid Racing team at the University of Idaho (UI) has developed a compact, lightweight, and mass centralized vehicle design with a rule-based energy management system. Major areas of innovation included an upright, spindle, and braking system that dramatically reduced rolling resistance, a close fitting frame design made possible by locating major components (engine, battery box, electric motor, and gas tank) close to the ground and to the center of gravity. The vehicle also incorporates a trailing link suspension, and realization of a rule-based energy management system that oversees operation of a Lynch electric motor as well as a YZ250F engine that is housed in a custom crankcase. The battery pack can initially store 2 MJ of energy in a single 50 lb. lithium polymer battery pack underneath the cockpit. The gas tank of the vehicle holds 33 MJ of energy in a 1.5 inch wide, 1.01 gallon tank immediately behind the cockpit. The resulting vehicle weighs 550 lbs. without the driver, achieves a top speed of 55 mph on the 75 meter acceleration track, and exhibits a hybrid fuel economy on the endurance course of 29 mpg. This is achieved by the implementation of a supervisory controller that turns on and off the electric motor as well as regulates the internal combustion engine in response to vehicle's speed and the battery pack's state of charge. Vehicle serviceability is greatly enhanced by reconfiguration of the low voltage system to be more accessible during track side operations. The vehicle described in this paper won the 2014 Formula Hybrid Society of Automotive Engineering (FHSAE) competition in Loudon, New Hampshire. It is currently undergoing comprehensive performance testing that will inform the design and operation of a next generation vehicle

## DESCRIPTION OF PROBLEM

The design of the UI FHSAE vehicle is intended to be similar to a mid-engine sports car with the most compact packaging possible for both power plants on the hybrid vehicle. This is realized by using a custom designed crankcase for the WR250F engine with its top end rotated towards the rear of the vehicle to allow for a tighter fit behind the driver and a parallel configuration for the hybrid powertrain. The electric motor is cantilevered off the engine crankcase and positioned inside the left rear suspension to allow for a direct coupling to the engine output shaft. By placing the electric motor off the side of the engine, more room is made under the seat to accommodate the battery pack and gas tank. This configuration moves the majority of the mass of the vehicle behind the driver. Given the placement of the powertrain and energy storage systems, a semi trailing link suspension was developed for the rear of the vehicle. This design allows the frame to fit closer to the major vehicle components of the vehicle, supporting the design goal of tighter vehicle packaging.

How the major components of the vehicle are set on the vehicle can greatly affect the performance of the vehicle powertrain systems, suspension systems, and overall efficiencies. The UI FHSAE vehicle was laid out to keep the majority of the mass of the vehicle tight behind the driver, producing a lightweight, compact, mass centralized design as shown in Figure 1.



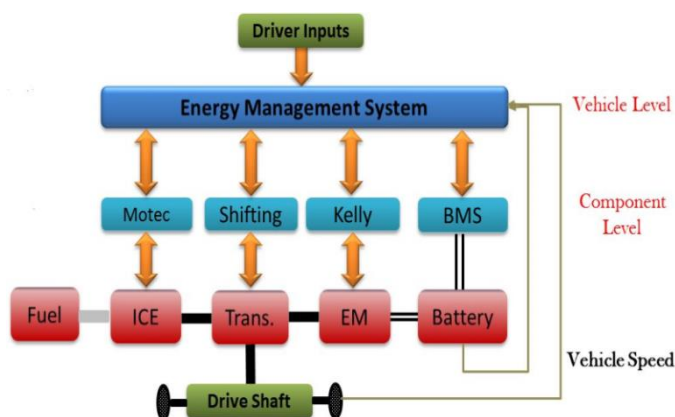
**Figure 1: Overall vehicle layout.**

One of the first major considerations in the design of a hybrid vehicle is the determination of the energy split. This entails making a decision about the percentage of electrical power and chemical power the vehicle will carry. There is a strict fuel allotment by the rules of the Formula Hybrid Competition. As such, students must choose between fuel efficiency and performance as the primary design goals of the project. Given the structure of the competition events, the University of Idaho team chose to focus on vehicle performance subject to the constraint of using nearly all on-board energy by the end of the endurance event. A power split of 95% gasoline and 5% electric was also supported by the belief that the team could tune the engine so that it would operate with an average efficiency greater than the average electric power plant efficiency. This was done based on an analysis of available energy densities for production battery cells when compared to the energy density of gasoline. Typical batteries have an energy density that is proportional to the weight of the cells, so battery cells were chosen for their low weight and volume, but high discharge rate to utilize the Lynch LEM 200 motor. This arrangement allowed for lighter overall weight of powertrain components and increased torque output of the electric power system.

After the basic layout of the vehicle and energy split of the powertrain had been set, the team began working on several other subsystems. This effort included characterizing the electric motor to be used on the vehicle, building a custom engine case to repack and improve a popular 4-stroke, 250cc motorcycle engine, while adhering to an extensive set of rules put forth by the competition. Other subsystems that were developed early on include the battery box, compact cell stack, suspension, and brakes.

## APPROACH AND METHODOLOGY

The Energy Management System (EMS) is designed to use a constant power split between the two powertrains when the vehicle is in hybrid mode. This was done for simplicity and to validate the design of the system before more time was invested into developing the system. The control loop for the EMS is shown below in Figure 2.

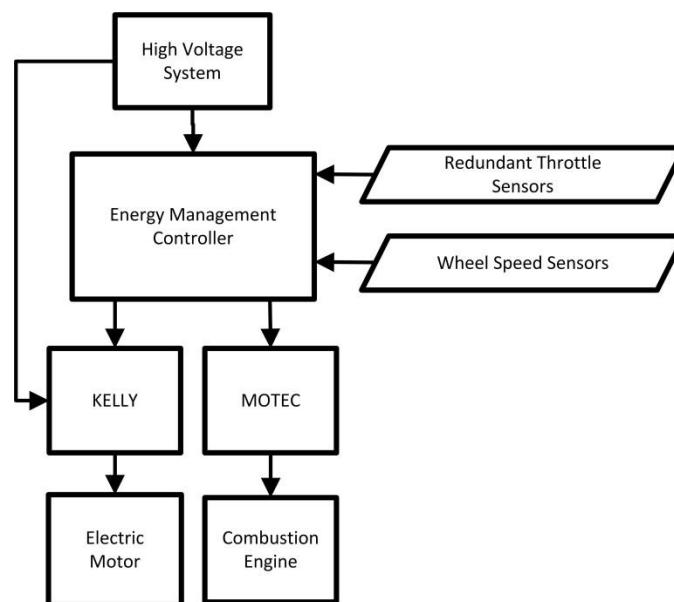


**Figure 2: Energy Management System control loop.**

The initial system used on the vehicle for the Energy Management System (EMS) was a passive system which passed the throttle demand from driver to both the electric motor and engine equally for maximum power output. Initial testing of the vehicle with the passive control system showed that the vehicle is able to achieve an average fuel economy of 17 mpg during an endurance style test. After some modifications to the brake system described below, the vehicle achieved an average fuel economy of 20.5 mpg with a high of 22 mpg. Both tests were conducted with only the internal combustion engine supplying the torque to the wheels. The simulations were conducted using GT Suite to model and develop the EMS at the University of Idaho, which revealed that the vehicle is capable of 25 mpg in hybrid mode without using the EMS [3]. Vehicle testing is currently underway to validate the simulation result.

## Control System

To improve the efficiency and performance of the vehicle, a control system was implemented. The control system is designed to be a simple system that would allow the user to control the power output from the two powertrain systems. The design goal of the control system is accomplished by intercepting the analog signals from the two rotational potentiometers used in the drive by wire system and passing a modified signal from the Max 32 micro controller to the ECU and motor controller. This simple design allowed for a variable power split that can be easily modified for different track conditions and events. The control system is also designed to function as an Energy Management System that changes powertrain modes from internal combustion only mode to hybrid mode. The system makes this change based upon feedback from the vehicle [3]. In Figure 3 below we can see the main control loop that is used on the vehicle.

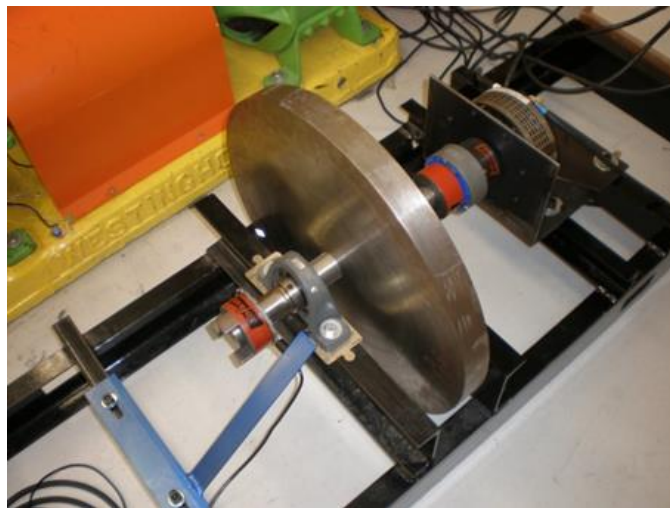


**Figure 3: Vehicle control scheme.**

## High Voltage System

The high voltage system consists of a custom built battery box developed in-house using 29 Haiyin lithium cobalt pouch cells stacked in single series string, creating a 6 Ah pack. With

the Haiyin cells stacked in series, the pack is capable of discharging at 300 amps continuously at 120 Volts. The battery pack is designed to use the Haiyin cells for their weight and discharge characteristics. The stack is designed to utilize the potential of the Lynch LEM 200 D135-RAGS motor selected for the car. The LEM 200 was picked due to its size and its compatibility with the engine developed for the vehicle. The LEM 200 is capable of 31 ft-lbs of torque and a continuous current of 200 amps at 110 Volts and will max out at 4400 rpm. The high voltage system also uses a KDH12601E Kelly Motor Controller rated for 600 amps that allows for regenerative braking. To determine the best use of the system, the team conducted a performance test of the motor to establish torque and efficiency of the motor as a function of current. To capture the torque and efficiency of the motor, the motor was coupled to an inertial dynamometer, and using a Love Joy connection and a Hall Effect sensor to collect speed and acceleration data. Figure 4 shows the experimental set up.

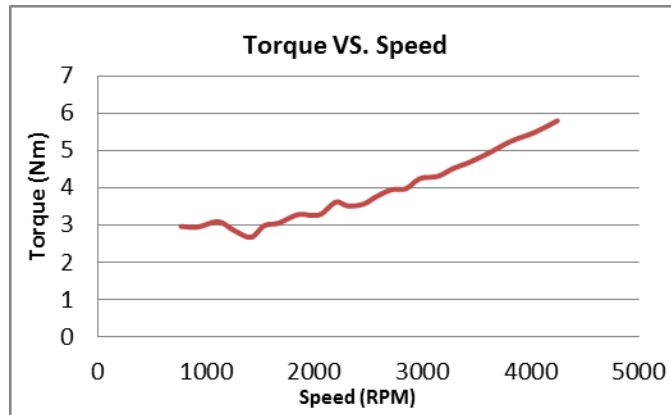


**Figure 4: Inertial dynamometer used for electrical testing.**

The test verified the torque curve for the LEM 200 over a small range of current due to limitations of the testing facilities. The testing conducted, at the highest torque recorded, have the inputs to the motor at 100 Volts and 27 amps. At the peak point tested, the electric motor produced 5.7 N-m of torque at 4400 rpm as shown in Figure 5. More testing is



required to gather a complete torque curve to be used in further simulations and to improve the control systems developed for the vehicle.



**Figure 5: Electric motor torque curve.**

The battery pack for the vehicle is designed to be lightweight and compact to allow the pack to be placed tight behind the driver, giving the vehicle a better balance and to keep the center of gravity lower to the ground. The battery pack shown in Figure 6 houses the 29 Lithium cobalt pouch cells along with an Electromotus Battery Management system, the main fusing for the high voltage lines, and the insulation relays used to control power out of the box in case of emergency as dictated by the rules of the competition.



**Figure 6: Fully assembled battery pack.**

The battery pack is designed to allow easy maintenance while remaining compact in size so that it will still fit the space behind the driver. Inside the pack there is a Bender IR155-3204 ground fault detection system that is wired in to the main shut down circuit of the vehicle. The circuit can be seen in Figure 6 in the lower right hand side of the pack. The purpose of the ground fault is to measure the potential at several different points on the vehicle and to open the isolation relays should the high voltage system ground out on the chassis. The pack also contains several other safety measures such as an LED circuit seen in the top, right side of the pack in Figure 6 that will turn on when the pack is active to signal to bystanders working on the vehicle that the system is active. The pack also contains a pre-charge discharge circuit seen on the right side of the pack which is used to charge the power lines running to the controller so that when the system is activated the impulse current is lessened to protect the controller. The circuit also functions to quickly dissipate the charge left in the power lines should the system go down, ensuring the safety of bystanders or driver in case of emergency. All of these features are required by the rules to ensure that the vehicle is a safe design.

The battery box is constructed using E-glass fiberglass as the outer housing material to conform to the rules of the competition. The E-glass composite has a young's modulus of 69 Gpa and a yield strength of 27 Mpa. The rules for the competition stipulate that the material used to construct the outer casing of the battery box be made of electrically isolating, mechanically robust material so that it can be rigidly mounted to the chassis such that the construction can withstand a 20 g deceleration in the horizontal plane and a 10 g deceleration in the vertical plane. A finite element analysis was conducted on the purposed geometry of the box to simulate the two decelerations to ensure that the model would be within the limits of the rules as seen in Figure 7.



**Figure 7: Finite element analysis showing the bottom of the battery box.**

The finite element analysis conducted in SolidWorks showed that under the worst loading scenario for the battery box, the average Von Mises stress was well below the yield strength of the E-glass composite. From the analysis, the area around the bolt holes that hold the box in place on the chassis see the largest stresses. Disregarding the sharp increase in the stress at the edge of the holes due to St. Venant's principle, the battery box material and design is considered more than adequate with a safety factor of 6.5 in its highest stress zone.

## Internal Combustion Engine

The competition has limited the displacement of 250 cc for all engines used on hybrid vehicles. The rules also stipulate that the engine must maintain a stock bore and stroke or have a restrictor plate used on the intake of the engine. The internal combustion system that was designed for the University of Idaho vehicle is a custom 250 cc engine with an in-house built lower-end crankcase that incorporates a torsen differential. Creating a custom engine case allowed the incorporation of several technologies found on a variety of different motorcycle engines. The design uses a Yamaha YZ250F engine top end because of the five valve configuration that provides wider dispersion of the fuel air mixture into the cylinder and its reputation for reliability under motorcycle racing conditions. To create the lower end case of the engine, a Yamaha WR250F case was reverse engineered using a faro arm connected with SolidWorks. With the resulting CAD model, it was fairly straightforward to rotate the top end of the engine backwards 30 degrees from its original position and incorporate the differential into the case. To reduce weight and to minimize the size of the

case, the engine uses a planetary gear reduction in place of a sprocket as the final gear reduction. The planetary gear reduction was sized to provide a 4.5 to 1 gear reduction which limited the top speed of the vehicle to around 65 mph. This is acceptable because the typical autocross and endurance tracks seen at the Formula Hybrid Competition have short straights where higher speeds are unachievable. The WR250F was also chosen because the competition requires all vehicles to have a starter incorporated into the design of the vehicle. Furthermore, the WR250F had taller gear ratios that allowed the vehicle to travel at faster speeds in the upper rpm bands of the engine. It is recognized that this could be at the expense of sacrificing high rpm torque output from the engine. However, the team determined through Matlab simulations that using the taller gear ratios from the WR in tandem with the electric motor would increase the performance of the vehicle more than if the YZ transmission were to be used.

To gain better efficiency from the engine and allow for more control, the internal combustion engine is outfitted with a drive by wire system. The throttle body is a Bosch 32mm throttle body that is controlled through the M800. This particular throttle body was chosen because of its similar size to the stock throttle body used on the vehicle. Previously the throttle body had a 40 mm bore and was used on the Yamaha WR250X engine. By downsizing the diameter of the throttle body it is intended to increase the velocity of the intake which would increase efficiency over a section of the rpm band where peak torque is produced for the engine while sacrificing fuel economy and power at the upper end of the engine. This scheme was done due to the design goal of improving torque or performance of the engine while improving efficiency. The throttle body can be seen in Figure 8.



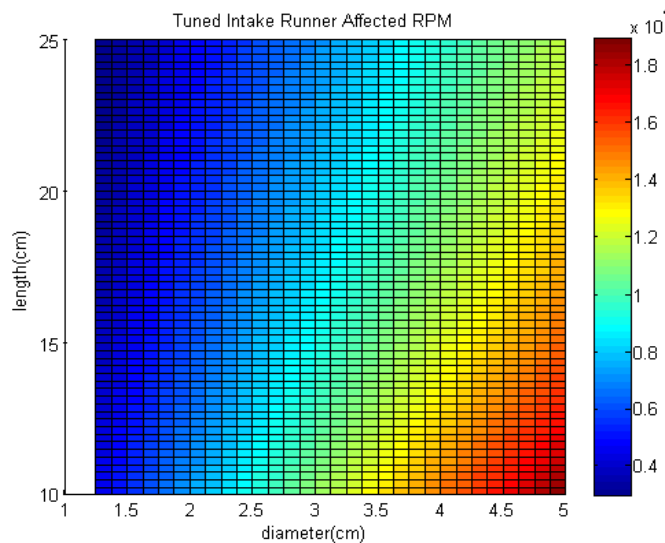
**Figure 8: Bosch 32mm throttle body.**

By choosing the 32 mm throttle body and the final gear reduction of the engine, we were able to increase the torque of the engine and increase fuel economy.

To help improve the efficiency of the engine and complement the drive by wire system that is implemented on the vehicle, a simple tuned intake was also created. To find the basic dimensions of the intake, a Helmholtz Resonator model was created to simulate the tuned intake and the rpm point that the intake would take effect. The mathematical equations used from Heywood can be found in Equations 1 and 2. A three dimensional plot of the model is shown below in Figure 9 that illustrates the various diameters, lengths and the accompanying rpm point that the volumetric efficiency of the engine would increase [1].

$$N_t(\text{rpm}) = \frac{955}{2} * a * (A/(l * V_{eff}))^{1/2} \quad (1)$$

$$V_{eff} = V_d * \frac{r_c + 1}{[2 * (r_c - 1)](\text{cm}^3)} \quad (2)$$



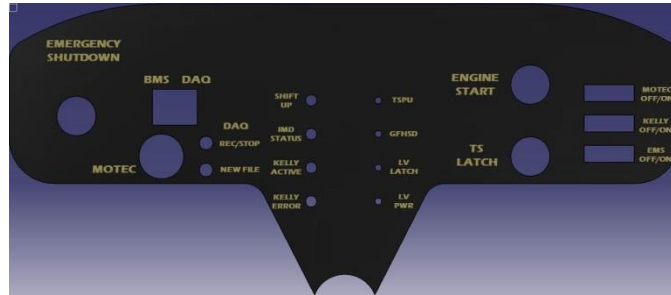
**Figure 9: Three dimensional pot of viable Helmholtz Resonator dimensions.**

The tuned intake chosen for the vehicle has a diameter of 1.5 inches and is 8.25 inches long. These dimensions are chosen based off the theoretical peak torque of the engine shown in Figure 12. The purpose of choosing this particular operating point is to increase the volumetric efficiency of the engine at peak torque. By elevating engine efficiency in the peak torque region the team supported its secondary goal of improving efficiency. The rationale behind this decision is that the electric motor will modulate so that the internal combustion engine will be running near or at peak torque for the majority of its operation.

### User Interface

The vehicle is also designed to have a user interface that allows drivers of different skill levels to operate the vehicle with ease. The user interface also improves trouble shooting times should one of the major systems fault out for any reason. The user interface that is used on the vehicle consists of an emergency tag out button, data acquisition operational buttons, along with two start buttons for the two powertrain systems. The user interface also has power shut down switches for the two controllers used in the powertrains systems as well as a selector switch to engage the Energy Management System from the passive system to active. To allow for quick trouble shooting of the whole vehicle a series of LED's have been mounted directly in front of the driver that signal when a particular subsystem is engaged and

operational. The LED's will turn off should the system loose power or shut down for whatever reason. The layout of the user interface can be seen in Figure 10 below.



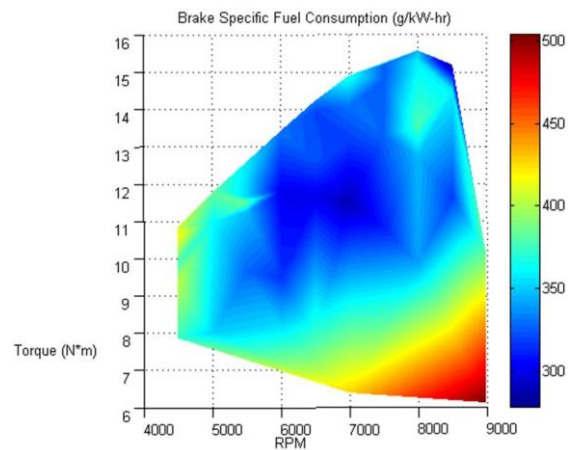
**Figure 10: User interface.**

To improve the use and understanding of the interface, the system has been clearly labeled and all of the functions are easily accessible to the driver without removing his or her hands from the steering wheel. The layout of the signal lights on the dash has been placed to allow drivers to easily see them from the standard seating position in the vehicle through the steering wheel. The vehicle has also been outfitted with an electronic Pingle shifter which uses a solenoid to shift the transmission with the push of a button mounted on the steering wheel allowing the driver to keep both hands on the steering wheel at all times during operation of the vehicle while improving shift times.

## FINDINGS; CONCLUSIONS; RECOMMENDATIONS

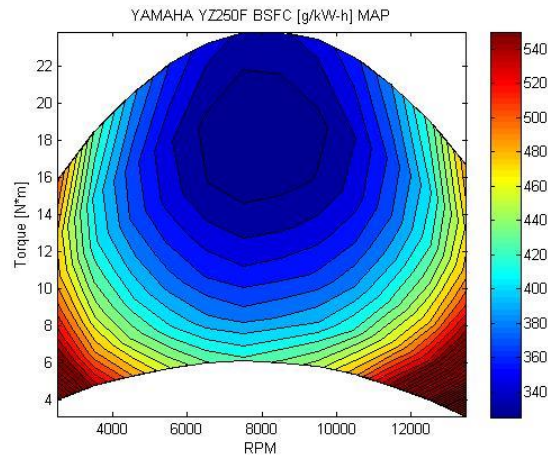
### Engine Simulation and Testing

To support the design of the vehicle control systems and to estimate fuel consumption over the driving course, Brake Specific Fuel Consumption (BSFC) maps were created using a companion 2-zone engine heat release model developed at the University of Idaho [2]. Figure 11 shows the results of the BSFC map that the team was able to measure before the original head of the engine was damaged due to a faulty oil pump in the engine. This is consistent with the theoretical brake specific fuel consumption map generated by the 2-zone heat release model shown in Figure 12.



**Figure 11: Experimental BSFC map.**





**Figure 12: Theoretical BSFC map.**

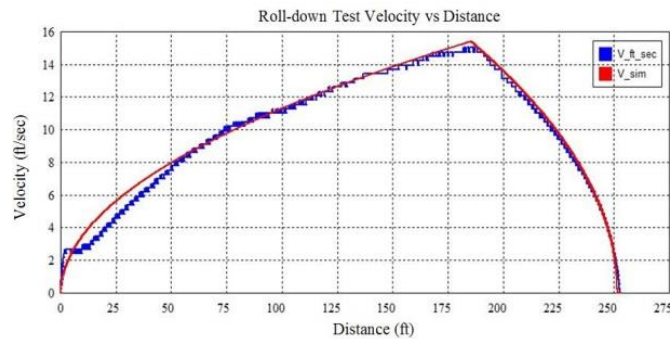
The points that were collected from the dynamometer engine before being damaged were compared to the theoretical torque and BSFC outputs from the model. The results of the comparison are shown below in Table 1. From Table 1 we can see that the relative error of the points tested is reasonably low with the expectation of the point tested at 63% throttle and 8500 rpm, which is where the engine began to fail. Therefore there is good confidence in using the theoretical BSFC map to define optimal control parameters with a vehicle level GT suite model [3].

**Table 1: Relative Error of Two Phase Engine Model**

Source	TP (%)	lambda	RPM	Torque (N*m)	Relative Error (%)	BSFC [g/kW-h]	Relative Error (%)
Exper	63	0.90	8500	14.51	7.51	358.12	3.80
Model				13.42		344.52	
Exper	70	0.89	8052	15.59	0.58	345.48	3.28
Model				15.68		334.14	
Exper	65.5	0.88	7009	14.91	2.62	368.44	6.30
Model				14.52		345.22	
Exper	60.5	0.88	5432	11.52	0.09	384.02	5.99
Model				11.53		407.04	
Exper	55.5	0.83	4958	11.80	2.63	382.68	8.61
Model				11.49		415.61	

## Vehicle Testing

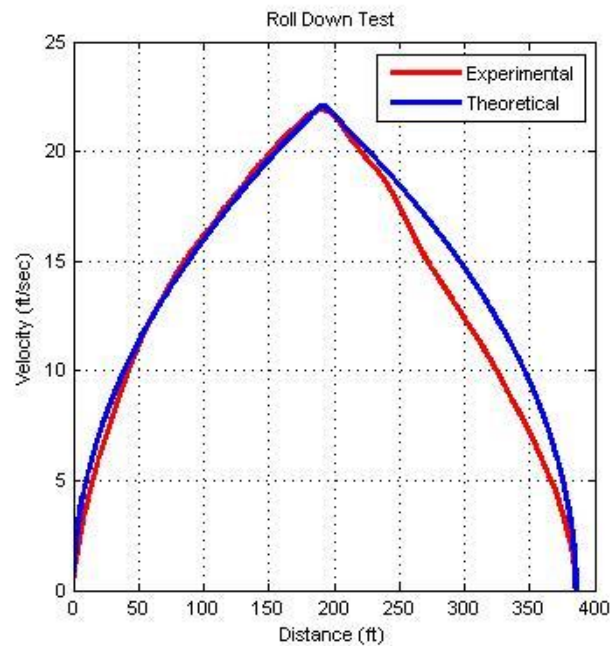
The rolling resistance of the vehicle can be affected by many attributes of the vehicle, such as weight, suspension setup and the tires used on the vehicle. Originally the rolling resistance of the vehicle was calculated using a TK solver model to predict and map experimental data acquired from testing conducted by the team. The first test conducted using the current vehicle was by a Masters student, for his thesis which included rolling the vehicle down a known and relatively constant slope onto a flat surface for the vehicle to roll out on [4]. During the test vehicle speed and time was collected using a data acquisition system on the vehicle and distance was recorded after the vehicle had come to a complete stop from the bottom of the slope. The test results shown in Figure 13 below show the vehicle had a rolling resistance of 0.06 with the initial setup of the braking system and suspension.



**Figure 13: Original roll down test conducted.**

From the results of the test it was concluded that the rolling resistance was too high for the vehicle and was significantly reducing the performance and efficiency of the vehicle. In order to redress the situation a study was conducted with the system found that the Brembo brake calipers were dragging on the rotors which seemed to be the most significant source of drag on the vehicle. The brake system underwent a redesign, resulting in the simplest and most cost effective course of action was to implement a set of retracting calipers that would fit with the upright design and rims used on the vehicle. The team found that Wilwood had kart calipers used for go-kart racing that retracted away from the rotors and would provide

enough stopping power with current setup of the brake pedal assembly. With the Wilwood Kart Calipers the team conducted another roll down test under the same conditions used in the previous test. The results in Figure 14 show that the rolling resistance of the vehicle was significantly reduced.



**Figure 14: Second roll down test with new brake design.**

To calculate the rolling resistance of the new design, data that was collected during the test was imported into the TK Solver model that was created to simulate the test. Using the TK Solver model the simulated curve was modified until a matching coefficient of rolling resistance was found that reduced the root mean square error of the curves. The best fit that was found using the TK Solver model showed a rolling resistance of 0.043 and a Root Mean Square (RMS) value of 78. By moving to the new calipers the design was significantly improved, which improved the efficiency of the vehicle as a whole.

**2014 Competition Vehicle**

The work done by the University of Idaho Formula Hybrid team resulted in the final product shown in Figure 15.



**Figure 15: University of Idaho 2014 SAE Formula Hybrid Vehicle.**

Basic vehicle specifications and performance values are shown in Table 2. The table also includes pertinent times for several different competition events simulated at our test track in Idaho.

**Table 2: General Statistics of the Vehicle**

Overall Dimensions	102 x 60 x 44 inches	
Overall Wet Weight	550 lbs	
Static Weight Distribution w/ Driver	45 % Front	55% Rear
Electric Acceleration 75 meters	6 seconds	
Hybrid Acceleration 75 meters	5.2 seconds	
Engine Peak HP@ rpm	33 HP @ 9500 rpm	
Engine Peak Torque @ rpm	20 ft-lbs@ 8500rpm	
Electric Motor Peak Power	24 HP	
Electric Motor Peak Torque	31 ft-lbs	

**Future Work**

From the results of testing and work done with the vehicle over past year, future work with the project will revolve around several key areas of the vehicle. The most critical area that

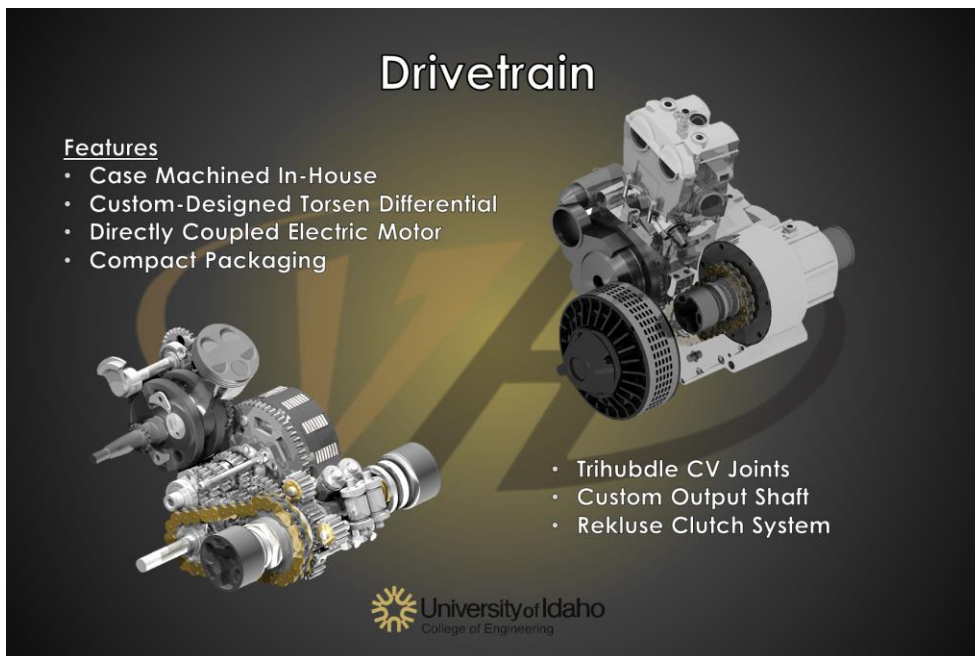
requires work is the improvement of the control system used for the powertrain of the vehicle. This work will revolve around the transient response of the vehicle to improve fuel economy over a wider range of operational parameters. The next largest area of improvement is the redesign of the battery box used on the vehicle. The current box design and layout needs to be simplified and lightened. The thermal expansion of the cells needs to be accounted for in the restraint system used in the box as well as the heat dissipation issue that arises due to heavy use. To improve the performance of the vehicle the un-sprung mass needs to be reduced in order to improve the handling of the vehicle, this is likely to be done by using carbon fiber tubes as uprights and exotic metals for the running gear and uprights used on the vehicle. Another area of development that will be explored is the use and implementation of an aero package on the vehicle. This work will be conducted in order to improve the handling and overall efficiency of the vehicle by reducing aerodynamic drag and increasing down force seen by the vehicle.

**REFERENCES**

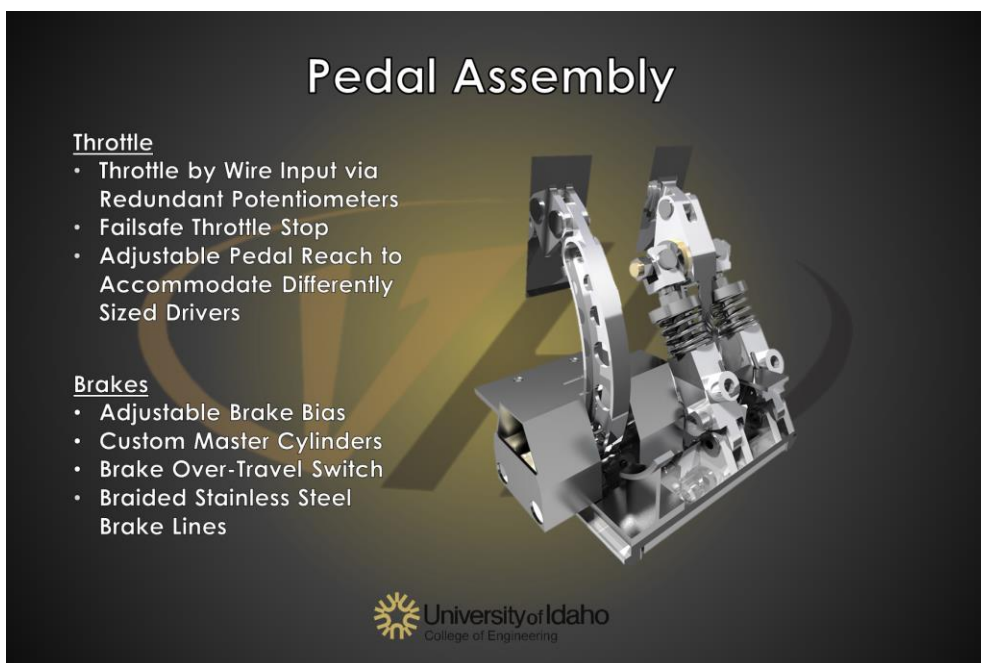
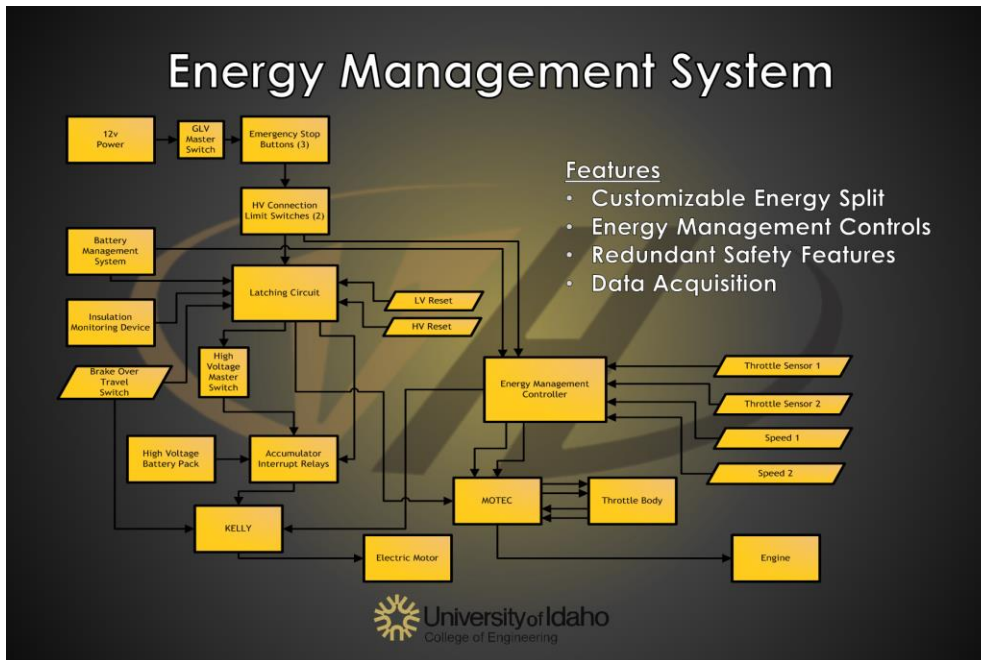
1. Heywood, J., "Internal Combustion Engine Fundamentals," (Tata McGraw-Hill) 312-313.
2. Cuddihy, J., "A User Friendly, Two Zone Heat Release Model for Predicting Spark-Ignition Engine Performance and Emission," M.S. thesis, Mechanical Engineering Department, University of Idaho, Moscow, 2014.
3. Asfoor, M., "Development and Optimization of A Rule Based Energy Management Strategy for Fuel Economy Improvement in Hybrid Electric Vehicle," Ph.D. thesis, Mechanical Engineering Department, University of Idaho, Moscow, 2014.
4. Rinker, D. "Use of a TK Solver Performance Model in the Design and Testing of Formula Hybrid Racecar," M.S. thesis, Mechanical Engineering Department, University of Idaho, Moscow, 2013.

APPENDIX A

Winning Team Banner and Posters Used at Competition





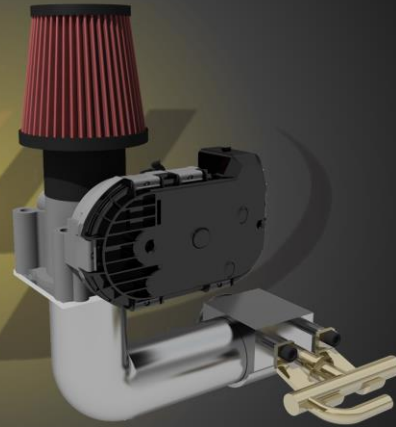




## Throttle Body and Intake

### Features

- Designed for Improved Volumetric Efficiency
- Built In-House
- Port Injection
- Bosch Electronic Throttle Body



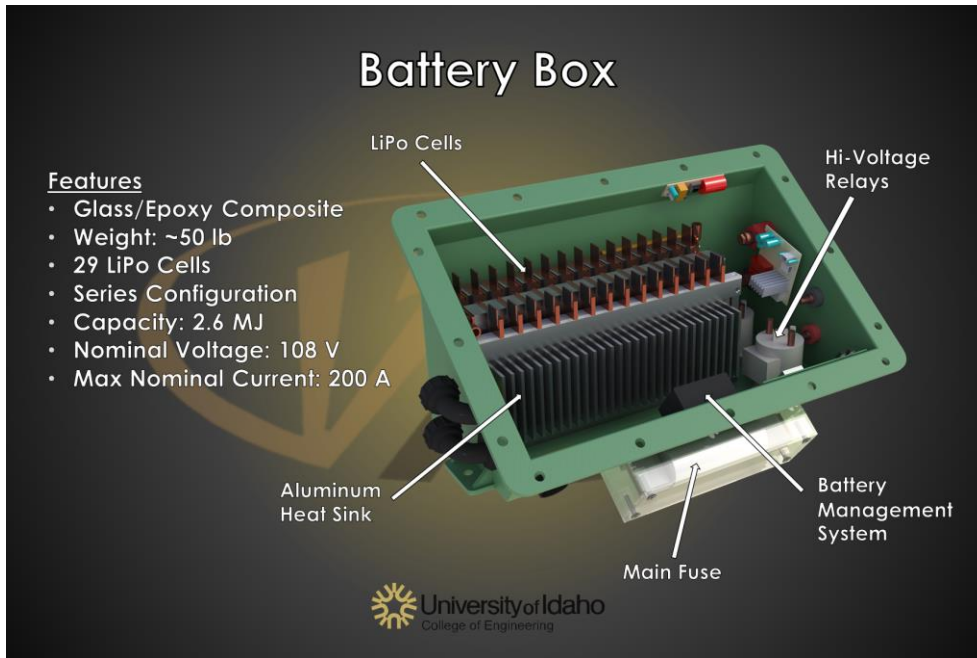
## Suspension

### Features

- Pull Rod Actuated Bell Cranks in Front
- Fully Adjustable A-Arms
- Fox Racing Shocks
- Welded Uprights
- Anti-Roll

- 1:1 Motion Ratio
- 1.12" Ride Height
- 1.25" Bump Travel
- 1" Droop Travel





**APPENDIX B**

Papers resulting from this project:

M. Asfoor, R. Lilley, and S. Beyerlein (2015), “Discrete Grid Optimization of a Rule-Based Energy Management Strategy for Formula Hybrid Electric Vehicle,” 2015 SAE World Congress, SAE Paper # 15FPL-0416.

R. Lilley, M. Asfoor, M. Santora, D. Cordon, E. Odom, and S. Beyerlein (2015), “Design of the University of Idaho Formula Hybrid Vehicle,” 2015 SAE World Congress, SAE Paper # 15MSEL-0007.